

Higher Past Papers

Mr Davie

September 2019

1 Intro

This document was created in order to make it easier to find past paper questions, both for teachers and students. I will do my best to keep this document up to date and include new past paper questions as they become available. If you spot any mistakes, or want to suggest any improvements, send me an email at MrDaviePhysics@gmail.com. I am more than happy to send you the Tex file used to produce the document so that you can modify it as you wish.

2 How to Use

The table on the next page contains links to questions sorted by topic and year. Clicking on a link will take you to that question. The marking instructions follow directly after each question with the exception of multiple choice questions and open ended questions. The answers to multiple choice are at the end of that section of multiple choice questions. I have not included the marking instructions for open ended questions as they do not contain enough information for you to mark your own work. Instead ask your teacher to have a look at what you have written. To return to the table click on [Back to Table](#) at the top or bottom of any page. Trying to navigate the document without doing this is tedious.

Before starting any past paper questions I recommend that you have paper copies of the Relationships Sheet and Data Sheet to avoid wasting time. If you don't have them then print pages [379-382](#) of this document.

	2015		2016		2017		2018		SPQ		2019	
	P1	P2	P1	P2	P1	P2	P1	P2	P1	P2	P1	P2
motion - equations and graphs	1, 2		1,2		1	1a,3	1,2		1,2	1a,b,3a(i)	1,3,4	1a,c
forces, energy and power	3,4,5,6		3	2c	2, 3		3,4	2	3,4	1c,d,2,3b	5	2
collisions, explosions, and impulse		2,3	4	3		2		3	5,6	3a(ii,iii)	6	1b
gravitation		1	5	1		5a(ii), 5b(ii)	5	1	7,8		2	4
special relativity	7			4	4	7d	6,7		9	4	8	7c(ii)
the expanding Universe	8	4b,5	6,7	5	5,6,7	1b,5b(i)		5,10c	10,11	5	9,10	5,6
forces on charged particles	10,11			7,8d		8	10	6	12,13	6	11,12	
the Standard Model	9	6	8,9			5a(i), 7a,b,c	8,9		14	7	13	7a,b,c(i)
nuclear reactions	12		10	8	8	9	11		15	7e,8	14	7d,8
inverse square law		8	15		14,15		12		16	9		9a(ii),b
wave-particle duality		7	11,12		9,10			7		10	15,16	
interference	13	9b	13	9	11	10	13	8	17	11		10
spectra	16	4a	16	12bii		6		10a,b	18		17,19	9a(i)
refraction of light	15	9a	14	10	12,13		14	9	19	12	18	11
monitoring and measuring AC	17,18		17		16			12	20,21		20,21	
current, potential difference, power, and resistance	18		19			14b(i)	15,16	2a(ii), 12b	22,23		23	
electrical sources & internal resistance		10		12a		12		11a,b	24	13		12
capacitors		11	20	13	17,18	13	17,18,19		25	14		13
semiconductors and p-n junctions	19			12bi	19	14a,b(ii)		11c		15	24	14
open ended		5,7		6,11		4,11		4,6c		5c,10c		3
unseen formula/graph plotting	20	12		14	20	15		13		16	7	5b,15
uncertainties	14			2(a,b)			20			11b(ii)	22,25	



National
Qualifications
2015

X757/76/02

**Physics
Section 1—Questions**

TUESDAY, 5 MAY

1:00 PM – 3:30 PM

Instructions for the completion of Section 1 are given on *Page two* of your question and answer booklet X757/76/01.

Record your answers on the answer grid on *Page three* of your question and answer booklet.

Reference may be made to the Data Sheet on *Page two* of this booklet and to the Relationships Sheet X757/76/11.

Before leaving the examination room you must give your question and answer booklet to the Invigilator; if you do not, you may lose all the marks for this paper.



DATA SHEET

COMMON PHYSICAL QUANTITIES

Quantity	Symbol	Value	Quantity	Symbol	Value
Speed of light in vacuum	c	$3.00 \times 10^8 \text{ m s}^{-1}$	Planck's constant	h	$6.63 \times 10^{-34} \text{ J s}$
Magnitude of the charge on an electron	e	$1.60 \times 10^{-19} \text{ C}$	Mass of electron	m_e	$9.11 \times 10^{-31} \text{ kg}$
Universal Constant of Gravitation	G	$6.67 \times 10^{-11} \text{ m}^3 \text{ kg}^{-1} \text{ s}^{-2}$	Mass of neutron	m_n	$1.675 \times 10^{-27} \text{ kg}$
Gravitational acceleration on Earth	g	9.8 m s^{-2}	Mass of proton	m_p	$1.673 \times 10^{-27} \text{ kg}$
Hubble's constant	H_0	$2.3 \times 10^{-18} \text{ s}^{-1}$			

REFRACTIVE INDICES

The refractive indices refer to sodium light of wavelength 589 nm and to substances at a temperature of 273 K.

Substance	Refractive index	Substance	Refractive index
Diamond	2.42	Water	1.33
Crown glass	1.50	Air	1.00

SPECTRAL LINES

Element	Wavelength/nm	Colour	Element	Wavelength/nm	Colour
Hydrogen	656	Red	Cadmium	644	Red
	486	Blue-green		509	Green
	434	Blue-violet		480	Blue
	410	Violet	Lasers		
	397	Ultraviolet	<i>Element</i>	<i>Wavelength/nm</i>	<i>Colour</i>
	389	Ultraviolet	Carbon dioxide	9550 } 10590 }	Infrared
Sodium	589	Yellow	Helium-neon	633	Red

PROPERTIES OF SELECTED MATERIALS

Substance	Density/kg m ⁻³	Melting Point/K	Boiling Point/K
Aluminium	2.70×10^3	933	2623
Copper	8.96×10^3	1357	2853
Ice	9.20×10^2	273	...
Sea Water	1.02×10^3	264	377
Water	1.00×10^3	273	373
Air	1.29
Hydrogen	9.0×10^{-2}	14	20

The gas densities refer to a temperature of 273 K and a pressure of $1.01 \times 10^5 \text{ Pa}$.

SECTION 1 — 20 marks

Attempt ALL questions

1. The following velocity-time graph represents the vertical motion of a ball.

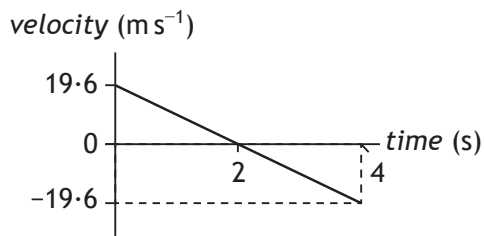

Which of the following acceleration-time graphs represents the same motion?

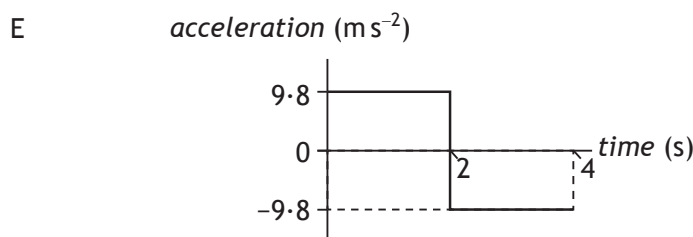
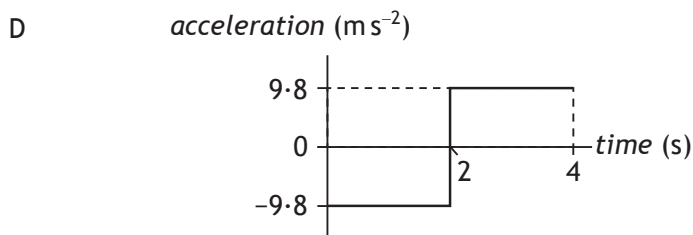
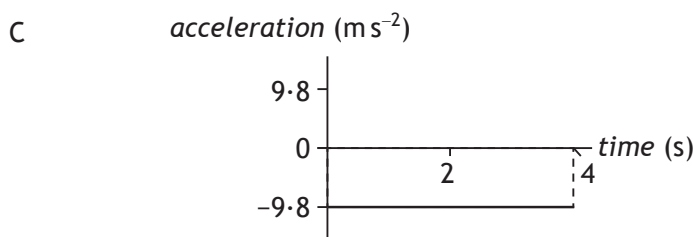
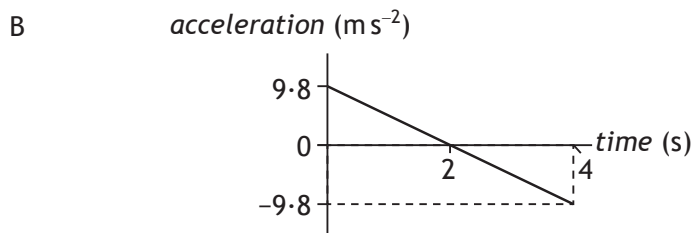
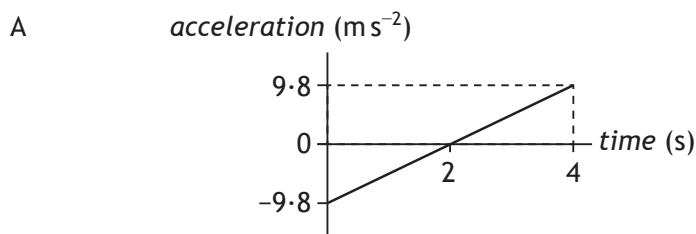

2. A car is travelling at 12 m s^{-1} along a straight road. The car now accelerates uniformly at -1.5 m s^{-2} for 6.0 s .

The distance travelled during this time is

- A 18 m
- B 45 m
- C 68 m
- D 72 m
- E 99 m.

3. A box of mass m rests on a slope as shown.

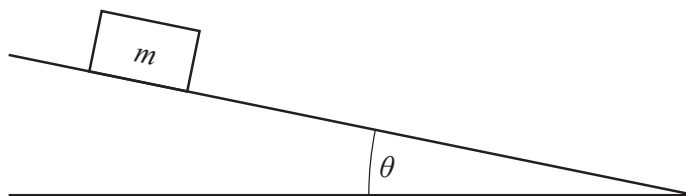

Which row in the table shows the component of the weight acting down the slope and the component of the weight acting normal to the slope?

	<i>Component of weight acting down the slope</i>	<i>Component of weight acting normal to the slope</i>
A	$mg \sin\theta$	$mg \cos\theta$
B	$mg \tan\theta$	$mg \sin\theta$
C	$mg \cos\theta$	$mg \sin\theta$
D	$mg \cos\theta$	$mg \tan\theta$
E	$mg \sin\theta$	$mg \tan\theta$

4. A person stands on bathroom scales in a lift.
The scales show a reading greater than the person's weight.
The lift is moving
- A upwards with constant speed
 - B downwards with constant speed
 - C downwards with increasing speed
 - D downwards with decreasing speed
 - E upwards with decreasing speed.

5. A car of mass 900 kg pulls a caravan of mass 400 kg along a straight, horizontal road with an acceleration of 2.0 m s^{-2} .

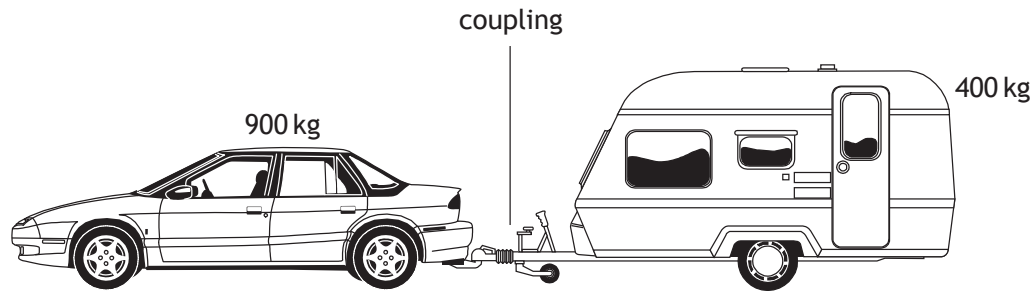

Assuming that the frictional forces on the caravan are negligible, the tension in the coupling between the car and the caravan is

- A 400 N
 - B 500 N
 - C 800 N
 - D 1800 N
 - E 2600 N.
6. Water flows at a rate of $6.25 \times 10^8 \text{ kg}$ per minute over a waterfall. The height of the waterfall is 108 m. The total power delivered by the water in falling through the 108 m is
- A $1.13 \times 10^9 \text{ W}$
 - B $1.10 \times 10^{10} \text{ W}$
 - C $6.62 \times 10^{11} \text{ W}$
 - D $4.05 \times 10^{12} \text{ W}$
 - E $3.97 \times 10^{13} \text{ W}$.
7. A spacecraft is travelling at a constant speed of $0.60c$ relative to the Moon. An observer on the Moon measures the length of the moving spacecraft to be 190 m. The length of the spacecraft as measured by an astronaut on the spacecraft is
- A 120 m
 - B 152 m
 - C 238 m
 - D 297 m
 - E 300 m.

[Turn over

8. A siren on an ambulance emits sound at a constant frequency of 750 Hz. The ambulance is travelling at a constant speed of 25.0 m s^{-1} towards a stationary observer. The speed of sound in air is 340 m s^{-1} . The frequency of the sound heard by the observer is

- A 695 Hz
- B 699 Hz
- C 750 Hz
- D 805 Hz
- E 810 Hz.

9. The emission of beta particles in radioactive decay is evidence for the existence of

- A quarks
- B electrons
- C gluons
- D neutrinos
- E bosons.

10. Two parallel metal plates X and Y in a vacuum have a potential difference V across them.

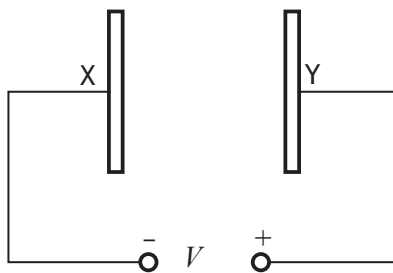

An electron of charge e and mass m , initially at rest, is released from plate X.

The speed of the electron when it reaches plate Y is given by

- A $\frac{2eV}{m}$
- B $\sqrt{\frac{2eV}{m}}$
- C $\sqrt{\frac{2V}{em}}$
- D $\frac{2V}{em}$
- E $\frac{2mV}{e}$

11. A potential difference of 2 kV is applied across two metal plates.
An electron passes between the metal plates and follows the path shown.

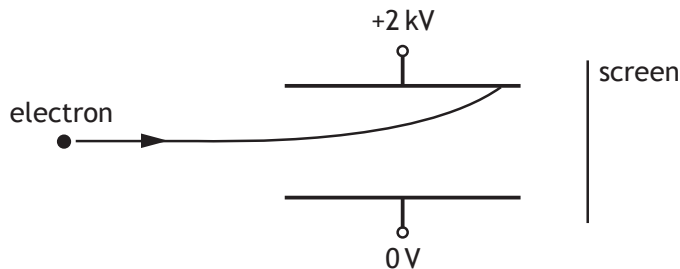

A student makes the following statements about changes that could be made to allow the electron to pass between the plates and reach the screen.

- I Increasing the initial speed of the electron could allow the electron to reach the screen.
- II Increasing the potential difference across the plates could allow the electron to reach the screen.
- III Reversing the polarity of the plates could allow the electron to reach the screen.

Which of these statements is/are correct?

- A I only
 - B II only
 - C III only
 - D I and II only
 - E I and III only
12. The following statement describes a fusion reaction.

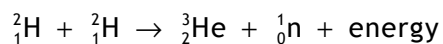

The total mass of the particles before the reaction is 6.684×10^{-27} kg.

The total mass of the particles after the reaction is 6.680×10^{-27} kg.

The energy released in the reaction is

- A 6.012×10^{-10} J
- B 6.016×10^{-10} J
- C 1.800×10^{-13} J
- D 3.600×10^{-13} J
- E 1.200×10^{-21} J.

[Turn over

13. Two identical loudspeakers, L_1 and L_2 , are operated at the same frequency and in phase with each other. An interference pattern is produced.

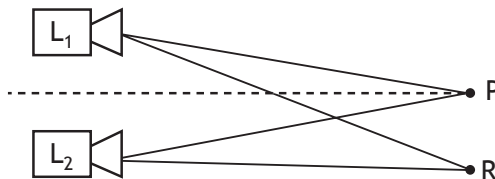

At position P, which is the same distance from both loudspeakers, there is a maximum.

The next maximum is at position R, where $L_1R = 5.6 \text{ m}$ and $L_2R = 5.3 \text{ m}$.

The speed of sound in air is 340 m s^{-1} .

The frequency of the sound emitted by the loudspeakers is

- A $8.8 \times 10^{-4} \text{ Hz}$
 - B $3.1 \times 10^1 \text{ Hz}$
 - C $1.0 \times 10^2 \text{ Hz}$
 - D $1.1 \times 10^3 \text{ Hz}$
 - E $3.7 \times 10^3 \text{ Hz}$.
14. An experiment is carried out to measure the wavelength of red light from a laser.
The following values for the wavelength are obtained.

650 nm 640 nm 635 nm 648 nm 655 nm

The mean value for the wavelength and the approximate random uncertainty in the mean is

- A $(645 \pm 1) \text{ nm}$
- B $(645 \pm 4) \text{ nm}$
- C $(646 \pm 1) \text{ nm}$
- D $(646 \pm 4) \text{ nm}$
- E $(3228 \pm 20) \text{ nm}$.

15. Red light is used to investigate the critical angle of two materials P and Q.

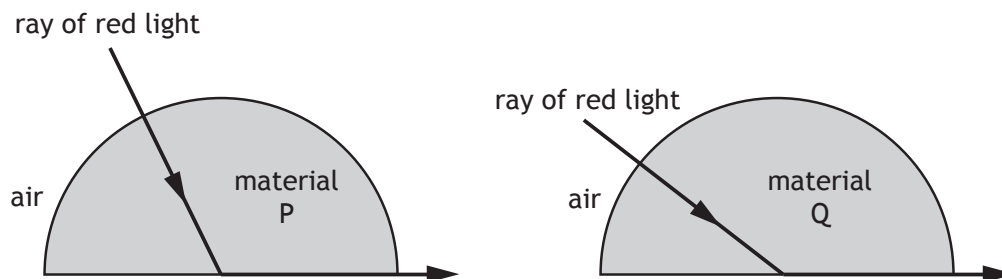

A student makes the following statements.

- I Material P has a higher refractive index than material Q.
- II The wavelength of the red light is longer inside material P than inside material Q.
- III The red light travels at the same speed inside materials P and Q.

Which of these statements is/are correct?

- A I only
 - B II only
 - C III only
 - D I and II only
 - E I, II and III
16. The diagram represents some electron transitions between energy levels in an atom.

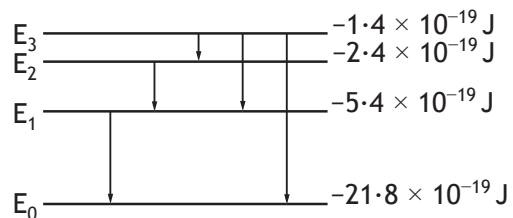

The radiation emitted with the shortest wavelength is produced by an electron making transition

- A E_1 to E_0
- B E_2 to E_1
- C E_3 to E_2
- D E_3 to E_1
- E E_3 to E_0 .

[Turn over

17. The output from a signal generator is connected to the input terminals of an oscilloscope. The trace observed on the oscilloscope screen, the Y-gain setting and the timebase setting are shown.

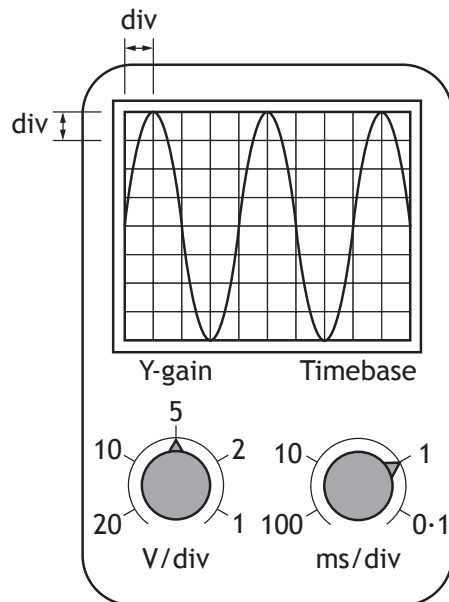

The frequency of the signal shown is calculated using the

- A timebase setting and the vertical height of the trace
 - B timebase setting and the horizontal distance between the peaks of the trace
 - C Y-gain setting and the vertical height of the trace
 - D Y-gain setting and the horizontal distance between the peaks of the trace
 - E Y-gain setting and the timebase setting.
18. A circuit is set up as shown.

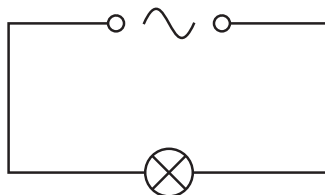

The r.m.s voltage across the lamp is 12 V.

The power produced by the lamp is 24 W.

The peak current in the lamp is

- A 0.71 A
- B 1.4 A
- C 2.0 A
- D 2.8 A
- E 17 A.

19. A student makes the following statements about energy bands in different materials.
- I In metals the highest occupied energy band is not completely full.
 - II In insulators the highest occupied energy band is full.
 - III The gap between the valence band and conduction band is smaller in semiconductors than in insulators.

Which of these statements is/are correct?

- A I only
 - B II only
 - C I and II only
 - D I and III only
 - E I, II and III
20. The upward lift force L on the wings of an aircraft is calculated using the relationship

$$L = \frac{1}{2} \rho v^2 A C_L$$

where:

- ρ is the density of air
- v is the speed of the wings through the air
- A is the area of the wings
- C_L is the coefficient of lift.

The weight of a model aircraft is 80.0 N.

The area of the wings on the model aircraft is 3.0 m².

The coefficient of lift for these wings is 1.6.

The density of air is 1.29 kg m⁻³

The speed required for the model aircraft to maintain a level flight is

- A 2.5 m s⁻¹
- B 3.6 m s⁻¹
- C 5.1 m s⁻¹
- D 12.9 m s⁻¹
- E 25.8 m s⁻¹.

[END OF SECTION 1. NOW ATTEMPT THE QUESTIONS IN SECTION 2
OF YOUR QUESTION AND ANSWER BOOKLET]

Detailed Marking Instructions for each question**Section 1**

Question	Answer	Mark
1.	C	1
2.	B	1
3.	A	1
4.	D	1
5.	C	1
6.	B	1
7.	C	1
8.	E	1
9.	D	1
10.	B	1
11.	A	1
12.	D	1
13.	D	1
14.	D	1
15.	A	1
16.	E	1
17.	B	1
18.	D	1
19.	E	1
20.	C	1

FOR OFFICIAL USE



--	--	--	--	--	--

National
Qualifications
2015

Mark

--

X757/76/01

**Physics
Section 1 – Answer Grid
and Section 2**

TUESDAY, 5 MAY

1:00 PM – 3:30 PM



* X 7 5 7 7 6 0 1 *

Fill in these boxes and read what is printed below.

Full name of centre

--

Town

--

Forename(s)

--

Surname

--

Number of seat

--

Date of birth

Day

--	--

Month

--	--

Year

--	--

Scottish candidate number

--	--	--	--	--	--	--	--	--	--

Total marks — 130

SECTION 1 — 20 marks

Attempt ALL questions.

Instructions for the completion of Section 1 are given on *Page two*.

SECTION 2 — 110 marks

Attempt ALL questions.

Reference may be made to the Data Sheet on *Page two* of the question paper X757/76/02 and to the Relationship Sheet X757/76/11.

Care should be taken to give an appropriate number of significant figures in the final answers to calculations.

Write your answers clearly in the spaces provided in this booklet. Additional space for answers and rough work is provided at the end of this booklet. If you use this space you must clearly identify the question number you are attempting. Any rough work must be written in this booklet. You should score through your rough work when you have written your final copy.

Use **blue** or **black** ink.

Before leaving the examination room you must give this booklet to the invigilator; if you do not, you may lose all the marks for this paper.



* X 7 5 7 7 6 0 1 0 1 *

SECTION 2 — 110 marks

Attempt ALL questions

1. The shot put is an athletics event in which competitors “throw” a shot as far as possible. The shot is a metal ball of mass 4.0 kg. One of the competitors releases the shot at a height of 1.8 m above the ground and at an angle θ to the horizontal. The shot travels through the air and hits the ground at X. The effects of air resistance are negligible.

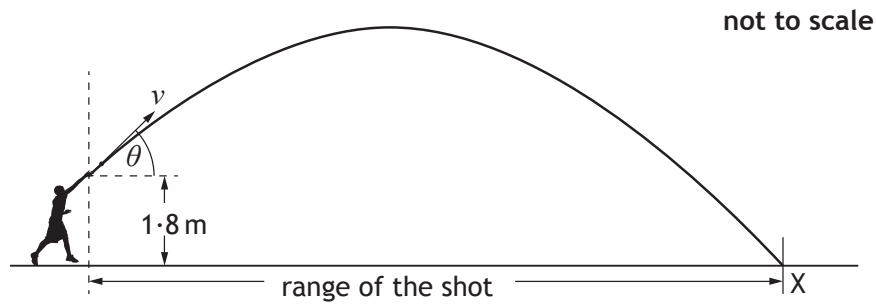

The graph shows how the release speed of the shot v varies with the angle of projection θ .

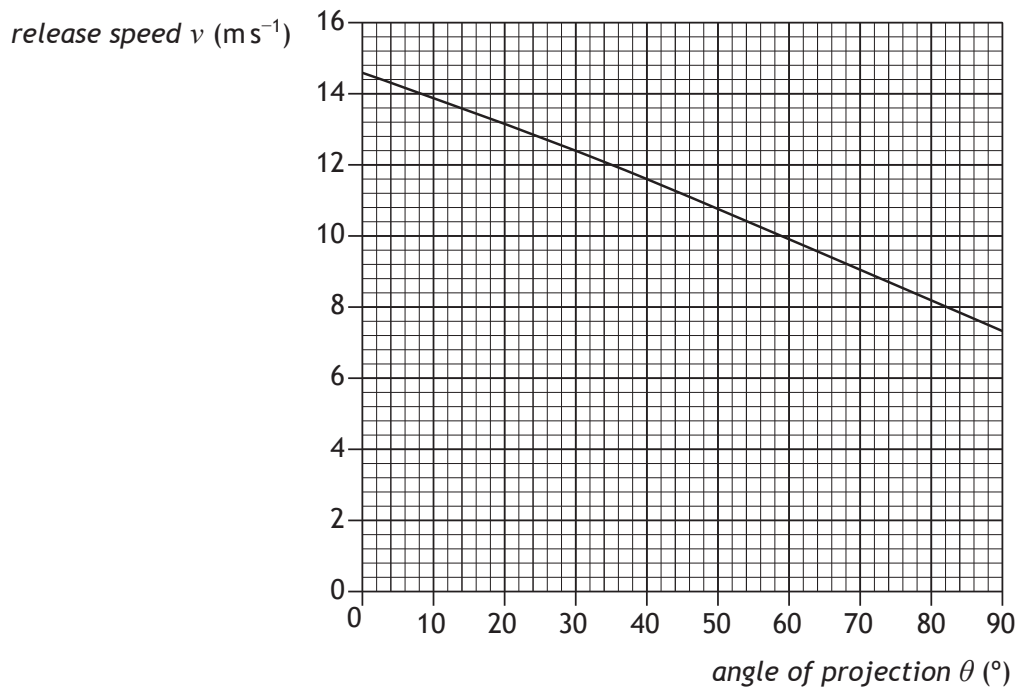

1. (continued)

MARKS DO NOT WRITE IN THIS MARGIN

(a) The angle of projection for a particular throw is 40° .

(i) (A) State the release speed of the shot at this angle.

1

(B) Calculate the horizontal component of the initial velocity of the shot.

1

Space for working and answer

(C) Calculate the vertical component of the initial velocity of the shot.

1

Space for working and answer

(ii) The maximum height reached by the shot is 4.7m above the ground. The time between release and reaching this height is 0.76s.

(A) Calculate the total time between the shot being released and hitting the ground at X.

4

Space for working and answer



1. (a) (ii) (continued)

(B) Calculate the range of the shot for this throw.

Space for working and answer

MARKS

DO NOT
WRITE IN
THIS
MARGIN

3

(b) Using information from the graph, explain the effect of increasing the angle of projection on the kinetic energy of the shot at release.

2



Section 2

Question			Answer	Max Mark	Additional Guidance
1.	(a)	(i)	A $v = 11.6 \text{ m s}^{-1}$ (1)	1	Unit required - incorrect or missing unit award 0 Accept m/s No other value accepted.
			B $v_h = 11.6 \cos 40$ $= 8.9 \text{ m s}^{-1}$ (1)	1	Or consistent with A Accept 8.886, 8.89, 9 but <u>not</u> 9.0 0 marks for mixing up B and C
			C $v_v = 11.6 \sin 40$ $= 7.5 \text{ m s}^{-1}$ (1)	1	Or consistent with A Accept 7.456, 7.46, 7 but <u>not</u> 7.0
		(ii)	A $s = ut + \frac{1}{2} at^2$ (1) $4.7 = 0 + \frac{1}{2} \times 9.8 \times t^2$ (1) $t = 0.979 \text{ (s)}$ (1) Total Time = $0.98 + 0.76$ $= 1.7 \text{ s}$ (1)	4	s and a must have the same sign $v^2 = u^2 + 2as$ $= 0 + 2 \times 9.8 \times 4.7$ $v = 9.6$ $v = u + at$ $9.6 = 0 + 9.8t$ $t = 0.979$ All formulae required to get final answer (1) Correct substitution into all (1) Answer of 0.979 (1) Watch for inappropriate intermediate rounding eg $t = 1$, treat as arithmetic error, max 3 marks Accept 2, 1.74, 1.739 but not 2.0 If $g = 9.81$ or 10 then incorrect substitution, maximum 1 mark for formula NB No secs in physics!

Question		Answer	Max	Additional Guidance
		B $v = \frac{d}{t}$ (1) $8.9 = \frac{d}{1.7}$ (1) $d = 15\text{m}$ (1)	3	$s = ut + \frac{1}{2}at^2$ or $s = \frac{1}{2}(u+v)t$ (1) Or consistent with (a)(ii)(A) <u>and</u> (a)(i)(B) Accept 20, 15.1, 15.13 If $t = 1.74$ accept 15, 15.5, 15.49
	(b)	kinetic energy is less (1) (as θ increases) speed decreases (1)	2	This statement is required before any marks awarded. If there is wrong physics in the answer then award 0 marks Can be done by calculation but it must be clearly indicated which angle applies to which kinetic energy to access the second mark. Wrong substitution in calculation method - award 0 marks (wrong physics) Alternative: (total energy remains the same) The greater the angle the more energy used to lift the putt to a greater height before release (1) Less energy available to convert to E_k (1)

2. A student sets up an experiment to investigate collisions between two trolleys on a long, horizontal track.

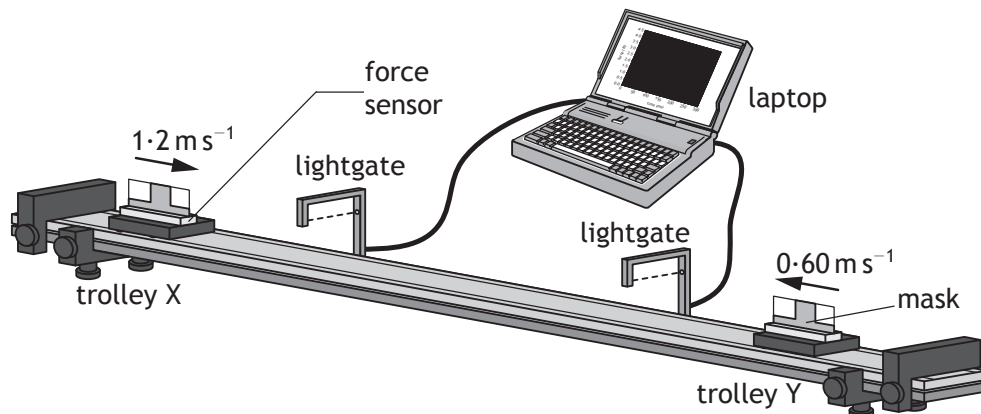

The mass of trolley X is 0.25 kg and the mass of trolley Y is 0.45 kg.

The effects of friction are negligible.

In one experiment, trolley X is moving at 1.2 m s^{-1} to the right and trolley Y is moving at 0.60 m s^{-1} to the left.

The trolleys collide and do not stick together. After the collision, trolley X rebounds with a velocity of 0.80 m s^{-1} to the left.

- (a) Determine the velocity of trolley Y after the collision.

3

Space for working and answer

[Turn over



MARKS
DO NOT
WRITE IN
THIS
MARGIN

2. (continued)

- (b) The force sensor measures the force acting on trolley Y during the collision.

The laptop displays the following force-time graph for the collision.

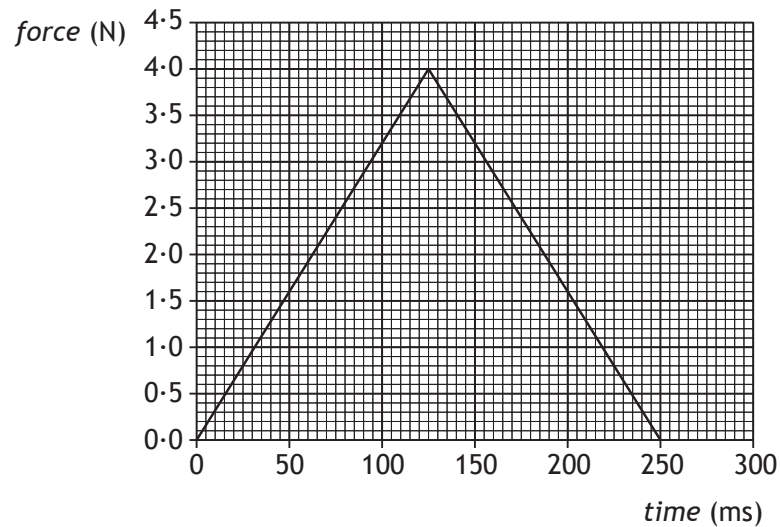

- (i) Determine the magnitude of the impulse on trolley Y.

3

Space for working and answer

- (ii) Determine the magnitude of the change in momentum of trolley X.

1



MARKS DO NOT WRITE IN THIS MARGIN

2. (b) (continued)

(iii) Sketch a velocity-time graph to show how the velocity of trolley X varies from 0.50s before the collision to 0.50s after the collision.

3

Numerical values are required on both axes.

You may wish to use the square-ruled paper on *Page thirty-six*.

[Turn over

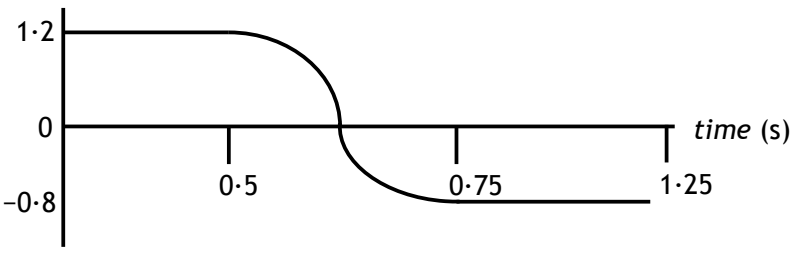

Question		Answer	Max Mark	Additional Guidance
2.	(a)	<p>(Total momentum before = total momentum after)</p> $m_x u_x + m_y u_y = m_x v_x + m_y v_y \quad (1)$ $(0.25 \times 1.20) + (0.45 \times -0.60)$ $= (0.25 \times -0.80) + (0.45 \times v_y) \quad (1)$ $0.30 - 0.27 = -0.20 + 0.45 \times v_y$ $0.45 \times v_y = 0.23$ $v_y = 0.51 \text{ ms}^{-1} \quad (1)$ <p>(to the right)</p>	3	<p>If sign convention not applied then max (1) for formula.</p> <p>Answer must be consistent with sign convention in substitution line.</p> <p>0.5, 0.511, 0.5111</p> <p>Where candidates calculate the momentum of each trolley individually both before and after, no marks are awarded unless correct addition (including sign convention) and equating takes place.</p>
	(b) (i)	<p>impulse = area under graph</p> $\left(= \frac{1}{2} b \times h \right) \quad (1)$ $= \frac{1}{2} \times 0.25 \times 4.0 \quad (1)$ $= 0.50 \text{ N s} \quad (1)$ <p>Accept 0.5, 0.500, 0.5000</p>	3	<p>Impulse = $mv - mu$</p> $= (0.45 \times 0.51) - (0.45 \times -0.60)$ $= 0.50 \text{ N s}$ <p>For alternative method accept: 0.5, 0.500, 0.4995</p> <p>Accept kg m s^{-1}</p>
	(ii)	$0.50 \text{ kg m s}^{-1} \quad (1)$	1	<p>Or consistent with (i)</p> <p>Accept N s</p> <p>Accept 0.5</p>

Question	Answer	Max Mark	Additional Guidance
(iii)	<p>velocity (m s⁻¹)</p>  <p>Constant velocity at correct values and signs before <u>and</u> after collision (1)</p> <p>Velocity change from initial to final in 0.25 s. (1)</p> <p>Shape of change of velocity correct ie initially gradual, increasing steepness then levelling out to constant velocity. (1)</p>	3	<p>The origin and at least one axis must be labelled with quantity or unit or both otherwise maximum 2 marks.</p>

MARKS
DO NOT
WRITE IN
THIS
MARGIN

3. A space probe of mass 5.60×10^3 kg is in orbit at a height of 3.70×10^6 m above the surface of Mars.

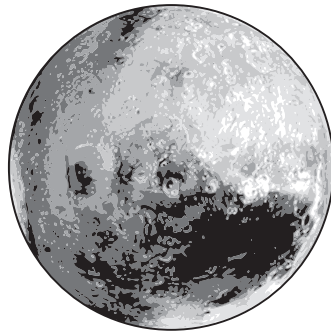

Mars



space probe

not to scale

The mass of Mars is 6.42×10^{23} kg.
The radius of Mars is 3.39×10^6 m.

- (a) Calculate the gravitational force between the probe and Mars. 3

Space for working and answer

- (b) Calculate the gravitational field strength of Mars at this height. 3

Space for working and answer



Question		Answer	Max Mark	Additional Guidance
3.	(a)	$F = \frac{GMm}{r^2} \quad (1)$ $F = \frac{6.67 \times 10^{-11} \times 6.42 \times 10^{23} \times 5.60 \times 10^3}{(3.39 \times 10^6 + 3.70 \times 10^6)^2} \quad (1)$ $F = 4.77 \times 10^3 \text{ N} \quad (1)$	3	Accept 4.8, 4.770, 4.7704
	(b)	$g = \frac{W}{m} \quad (1)$ $g = \frac{4770}{5600} \quad (1)$ $g = 0.852 \text{ N kg}^{-1} \quad (1)$	3	Or consistent with (a) $F = ma$ is acceptable If candidate uses $g = \frac{GM}{r^2}$ and has already lost marks in (a) for not adding the radius to the height, do not penalise for a second time. (Gives 3.13) if r is consistent with (a). Accept m s^{-2}

MARKS
DO NOT
WRITE IN
THIS
MARGIN

4. Light from the Sun is used to produce a visible spectrum.
A student views this spectrum and observes a number of dark lines as shown.

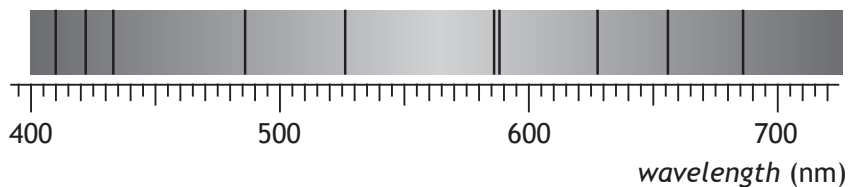

- (a) Explain how these dark lines in the spectrum of sunlight are produced. 2

- (b) One of the lines is due to hydrogen.

The position of this hydrogen line in the visible spectrum is shown for a distant galaxy, a nearby galaxy and the Sun.

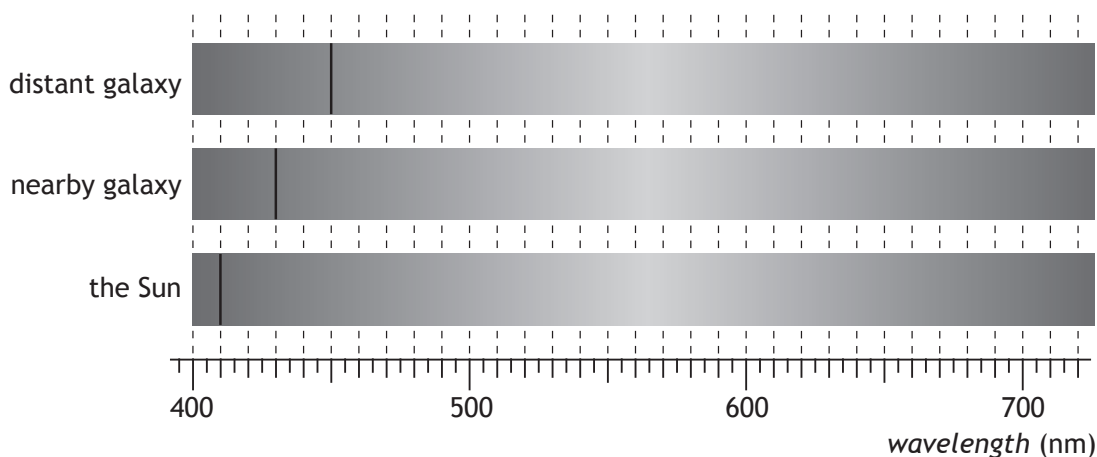

- (i) Explain why the position of the line is different in each of the spectra. 2



MARKS DO NOT
WRITE IN
THIS
MARGIN

4. (b) (continued)

- (ii) Show that the redshift of the light from the distant galaxy is 0.098.

2

Space for working and answer

- (iii) Calculate the approximate distance to the distant galaxy.

5

Space for working and answer

[Turn over



Question		Answer	Max Mark	Additional Guidance
4.	(a)	<p>photons of particular/some/certain energies/frequencies are absorbed (1)</p> <p>in its/the Sun's (upper/outer) atmosphere/outer layers (1)</p>	2	<p>1st mark stands alone</p> <p>Particular/some/certain frequencies/wavelengths of light/radiation are absorbed (1)</p> <p>'the atmosphere' is too vague</p> <p>Accept gases or suitable named gases in place of atmosphere but not elements or atoms on their own.</p>
	(b) (i)	<p>light is redshifted/ shifted <u>towards</u> red (1)</p> <p>(as) the galaxies are moving away (from the Sun) (1)</p>	2	<p>accept: the wavelength (λ) has increased/ frequency (f) has decreased /lines have been redshifted</p> <p>Not 'blueshift'/becomes red/shifted to red - this is wrong physics, award 0 marks.</p> <p>Or further galaxies have greater <u>recessional</u> velocity</p> <p>Or equivalent</p>
	(ii)	$z = \frac{\lambda_{observed} - \lambda_{rest}}{\lambda_{rest}} \quad (1)$ $= \frac{450 \times 10^{-9} - 410 \times 10^{-9}}{410 \times 10^{-9}} \quad (1)$ $= 0.098$	2	<p>Must start with the appropriate relationship</p> <p>Accept $\frac{450 - 410}{410}$</p> <p>Award maximum of 1 mark if final answer is not 0.098</p>
	(iii)	$z = \frac{v}{c} \quad (1)$ $0.098 = \frac{v}{3.00 \times 10^8} \quad (1)$ <p>($v = 2.94 \times 10^7 \text{ m s}^{-1}$)</p> $v = H_0 d \quad (1)$ $2.94 \times 10^7 = 2.3 \times 10^{-18} \times d \quad (1)$ $d = 1.3 \times 10^{25} \text{ m} \quad (1)$ <p>($1.4 \times 10^9 \text{ ly}$)</p>	5	<p>-anywhere</p> <p>Must use 0.098 otherwise incorrect substitution - max 2 marks</p> <p>-anywhere</p> <p>Accept 1×10^{25}, 1.28×10^{25}, 1.278×10^{25}</p> <p>There is no need to convert to light years but if done must be correct otherwise max 4 marks.</p>

5. A quote from a well-known science fiction writer states:

“In the beginning there was nothing, which exploded.”

Using your knowledge of physics, comment on the above statement.

MARKS

DO NOT
WRITE IN
THIS
MARGIN

3



	MARKS	DO NOT WRITE IN THIS MARGIN
6. (a) The Standard Model classifies <i>force mediating particles</i> as bosons. Name the boson associated with the electromagnetic force.	1	
(b) In July 2012 scientists at CERN announced that they had found a particle that behaved in the way that they expected the Higgs boson to behave. Within a year this particle was confirmed to be a Higgs boson. This Higgs boson had a mass-energy equivalence of 126 GeV. (1 eV = 1.6×10^{-19} J)		
(i) Show that the mass of the Higgs boson is 2.2×10^{-25} kg. <i>Space for working and answer</i>	3	
(ii) Compare the mass of the Higgs boson with the mass of a proton in terms of orders of magnitude. <i>Space for working and answer</i>	2	

[Turn over



* X 7 5 7 7 6 0 1 1 7 *

Question		Answer	Max Mark	Additional Guidance
6.	(a)	Photon	1	
	(b)	(i)	3	<p>If candidate does not show this line, either separately or in the formula, then max 2 marks may be awarded.</p> <p>-anywhere Alternative:</p> $E = mc^2 \quad (1)$ $126 \times 10^9 \times (1.6 \times 10^{-19}) = m \times (3 \times 10^8)^2 \quad (1)$ $m = 2.2 \times 10^{-25} \text{ (kg)} \quad (1)$ <p>Max 2 marks if final answer not given</p>
		(ii)	2	<p>or $10^{-25} / 10^{-27} = 100$</p> <p>or $2.2 \times 10^{-25} / 1.67 \times 10^{-27} =$</p> <p>or $2.2 \times 10^{-25} / 1.7 \times 10^{-27} =$</p> <p>or $2.24 \times 10^{-25} / 1.673 \times 10^{-27} =$</p> <p>etc</p> <p>Accept 100, 10^2, 132, 131.5, 134, 133.9, etc (1)</p> <p>If mass of neutron used treat as wrong physics - award 0 marks</p> <p>'2 bigger' on its own is worth 2 marks</p>

MARKS

DO NOT
WRITE IN
THIS
MARGIN

7. The use of analogies from everyday life can help better understanding of physics concepts. Throwing different balls at a coconut shy to dislodge a coconut is an analogy which can help understanding of the photoelectric effect.



Use your knowledge of physics to comment on this analogy.

3



MARKS
DO NOT
WRITE IN
THIS
MARGIN

8. A student investigates how irradiance I varies with distance d from a point source of light.

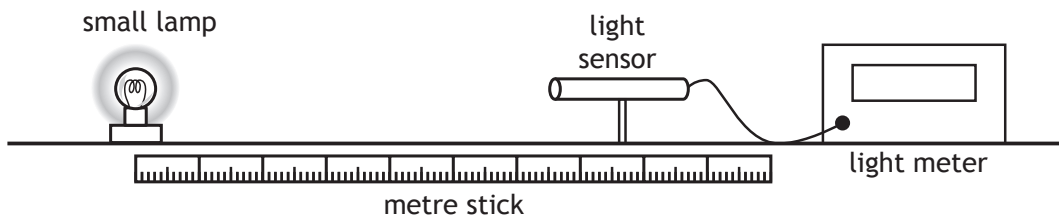

The distance between a small lamp and a light sensor is measured with a metre stick. The irradiance is measured with a light meter.

The apparatus is set up as shown in a darkened laboratory.

The following results are obtained.

d (m)	0.20	0.30	0.40	0.50
I (W m^{-2})	134.0	60.5	33.6	21.8

- (a) State what is meant by the term *irradiance*.

1

- (b) Use **all** the data to establish the relationship between irradiance I and distance d .

3



8. (continued)

MARKS
DO NOT
WRITE IN
THIS
MARGIN

- (c) The lamp is now moved to a distance of 0.60 m from the light sensor.
Calculate the irradiance of light from the lamp at this distance.

3

Space for working and answer

- (d) Suggest one way in which the experiment could be improved.
You **must** justify your answer.

2

- (e) The student now replaces the lamp with a different small lamp.
The power output of this lamp is 24 W.
Calculate the irradiance of light from this lamp at a distance of 2.0 m.

4

Space for working and answer



* X 7 5 7 7 6 0 1 2 1 *

Question		Answer	Max Mark	Additional Guidance
8.	(a)	The power per unit area (incident on a surface)	1	Accept power per square metre (m ²)
	(b)	$134 \times 0.2^2 = 5.4$ $60.5 \times 0.3^2 = 5.4$ $33.6 \times 0.4^2 = 5.4$ $21.8 \times 0.5^2 = 5.5$ (2) Statement of $I \times d^2 = \text{constant}$ (1)	3	If only 3 sets of data used correctly then maximum 2 marks. If 2 sets of data used correctly then maximum 1 mark (for relationship) If only 1 set of data used award 0 marks. Must be clear how the candidate has used the data to obtain the relationship. Ignore inappropriate averaging in this case. Accept straight line graph proof A sketch graph is not acceptable. 1 mark for all 4 points plotted correctly and best fit line 1 mark for correct axes including scales and labels ie I and $1/d^2$ (ignore units) 1 mark for statement of $I \times d^2 = \text{constant}$ only if some or all data has been used $I \times d^2$ is equivalent to $I \propto 1/d^2$ Accept $I_1 d_1^2 = I_2 d_2^2$
	(c)	$I \times d^2 = 5.4$ (1) $I \times 0.60^2 = 5.4$ (1) $I = 15 \text{ W m}^{-2}$ (1)	3	Can use $I_1 d_1^2 = I_2 d_2^2$ Watch for a variation in answers due to data used.

Question		Answer	Max Mark	Additional Guidance
	(d)	Smaller lamp (1) Will be more like a point source (1) or Black cloth on bench (1) to reduce reflections (1)	2	Accept Use a more precise instrument to reduce the (absolute) uncertainty. Must provide justification which is not wrong physics, otherwise 0 marks Do not accept 'repeat it' (since there is little variation in the calculated value of the constant/ spread of points from best fit line)
	(e)	$A = 4\pi r^2 = 4\pi \times 2^2 = 50.265$ (1) $I = \frac{P}{A}$ (1) $I = 24/50.265$ (1) $I = 0.48 \text{ W m}^{-2}$ (1)	4	-anywhere Accept 0.5, 0.477, 0.4775

MARKS
DO NOT
WRITE IN
THIS
MARGIN

9. A student carries out two experiments to investigate the spectra produced from a ray of white light.

(a) In the first experiment, a ray of white light is incident on a glass prism as shown.

not to scale

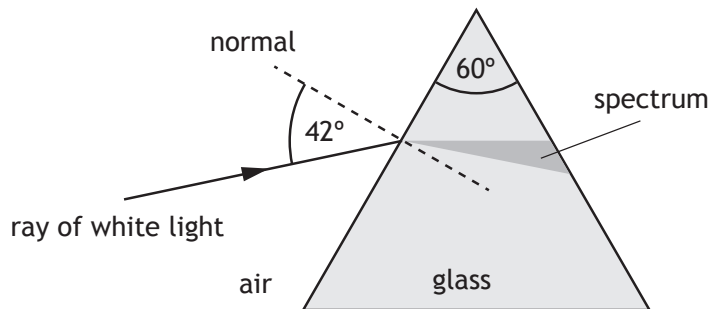

(i) Explain why a spectrum is produced in the glass prism.

1

(ii) The refractive index of the glass for red light is 1.54.
Calculate the speed of red light in the glass prism.

3

Space for working and answer



MARKS
DO NOT
WRITE IN
THIS
MARGIN

9. (continued)

(b) In the second experiment, a ray of white light is incident on a grating.

not to scale

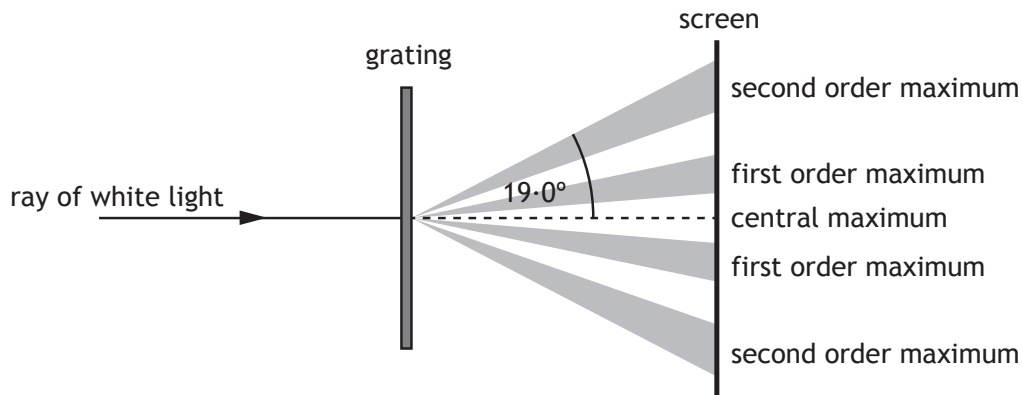

The angle between the central maximum and the second order maximum for red light is 19.0° .
The frequency of this red light is 4.57×10^{14} Hz.

(i) Calculate the distance between the slits on this grating.

5

Space for working and answer

(ii) Explain why the angle to the second order maximum for blue light is different to that for red light.

3



Question			Answer	Max Mark	Additional Guidance
9.	(a)	(i)	<ul style="list-style-type: none"> Different frequencies/ colours have different <u>refractive indices</u> (1) <p>or</p> <ul style="list-style-type: none"> Different frequencies/ colours are <u>refracted</u> through different angles (1) 	1	<p>Do NOT accept “bending” on its own but ignore it if follows ‘refraction’</p> <p>Do not accept ‘different amounts’.</p> <p>Not wavelength or speed on its own but ignore if reference made to frequency or colour.</p> <p>A correct answer followed by ‘diffract’ or ‘defract’, 0 marks</p>
		(ii)	$n = \frac{v_1}{v_2} \quad (1)$ $1.54 = \frac{3.00 \times 10^8}{v_2} \quad (1)$ $v_2 = 1.95 \times 10^8 \text{ m s}^{-1} \quad (1)$	3	<p>Accept 1.9, 1.948, 1.9481</p> <p>Example of inappropriate intermediate rounding:</p> $n = \frac{\sin \theta_1}{\sin \theta_2}$ $1.54 = \frac{\sin 42}{\sin \theta_2}$ $\theta_2 = 25.75^\circ = 26^\circ$ $\frac{v_1}{v_2} = \frac{\sin \theta_1}{\sin \theta_2}$ $\frac{3.00 \times 10^8}{v_2} = \frac{\sin 42}{\sin 26}$ $v_2 = 2.0 \times 10^8 \text{ m s}^{-1}$ <p>(max 2 marks)</p>

Question		Answer	Max Mark	Additional Guidance
	(b) (i)	$v = f\lambda$ (1) $3.00 \times 10^8 = 4.57 \times 10^{14} \times \lambda$ (1) $\lambda = 656.5 \times 10^{-9}$ $m\lambda = d\sin\theta$ (1) $2 \times 656.5 \times 10^{-9} = d \times \sin 19.0$ (1) $d = 4.03 \times 10^{-6} \text{ m}$ (1)	5	-anywhere Inappropriate intermediate rounding eg 660, treat as arithmetic error max 4 marks -anywhere Accept 4.0, 4.033, 4.0327 If candidates go on to calculate 1/d then do not award the final mark for answer
	(ii)	<ul style="list-style-type: none"> • different colours have different λ (1) • $m\lambda = d \sin\theta$ (1) • (m and d are the same) • θ is different for different λ (1) or <ul style="list-style-type: none"> • different colours have different λ (1) • Path difference = $m\lambda$ (1) • (for the same m) • PD is different for different λ (1) 	3	Any answer using different colours/wavelengths diffract/refracts different amounts as the explanation is wrong physics, award 0 marks Any answer using wrong physics, award 0 marks. $2\lambda = d\sin\theta$ is ok Path difference = 2λ is ok Can be done by recalculation but must include the first statement else maximum 2 marks.

10. A car battery is connected to an electric motor as shown.

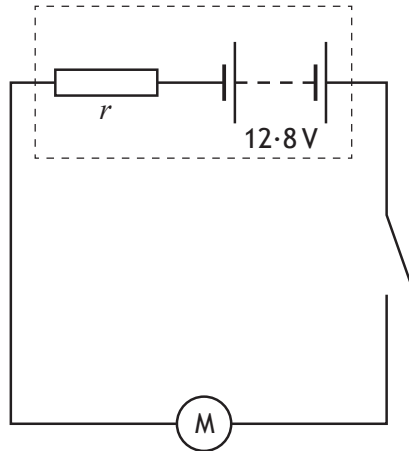

The electric motor requires a large current to operate.

- (a) The car battery has an e.m.f. of 12.8 V and an internal resistance r of $6.0 \times 10^{-3} \Omega$. The motor has a resistance of 0.050Ω .

(i) State what is meant by an *e.m.f. of 12.8 V*.

1

(ii) Calculate the current in the circuit when the motor is operating.

3

Space for working and answer

(iii) Suggest why the connecting wires used in this circuit have a large diameter.

1



* X 7 5 7 7 6 0 1 2 5 *

MARKS
DO NOT
WRITE IN
THIS
MARGIN

10. (continued)

(b) A technician sets up the following circuit with a different car battery connected to a variable resistor R .

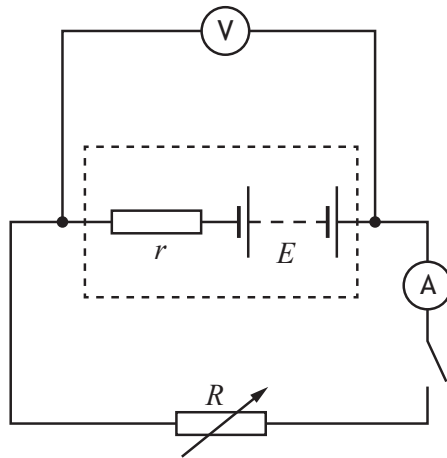

Readings of current I and terminal potential difference V from this circuit are used to produce the following graph.

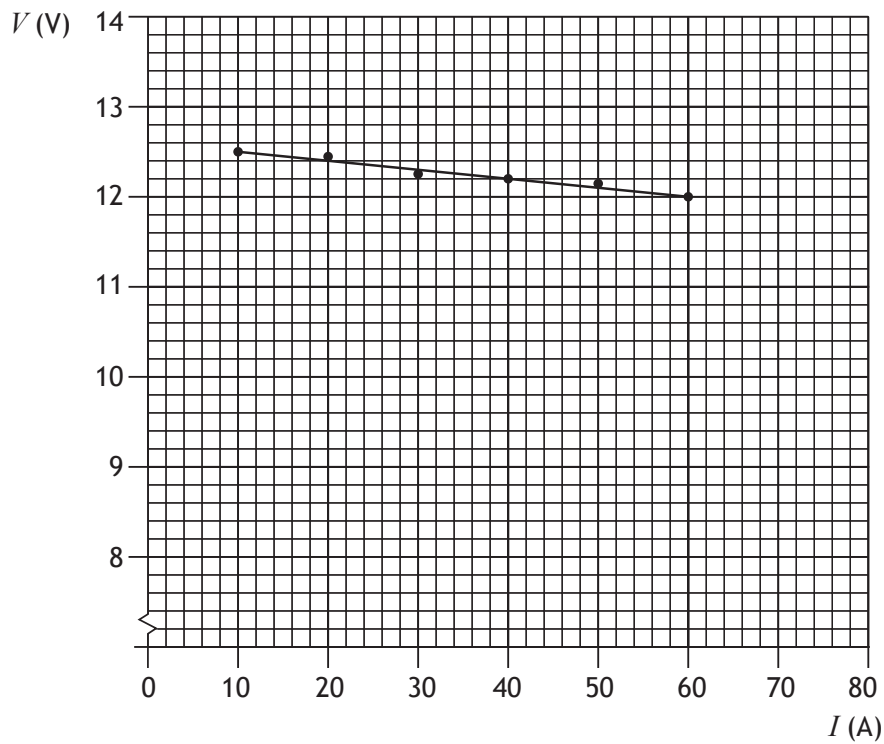

10. (b) (continued)

Use information from the graph to determine:

- (i) the e.m.f. of the battery;

Space for working and answer

MARKS DO NOT
WRITE IN
THIS
MARGIN

1

- (ii) the internal resistance of the battery;

Space for working and answer

3

[Turn over



10. (b) (continued)

- (iii) After being used for some time the e.m.f. of the battery decreases to 11.5V and the internal resistance increases to 0.090Ω .

The battery is connected to a battery charger of constant e.m.f. 15.0V and internal resistance of 0.45Ω as shown.

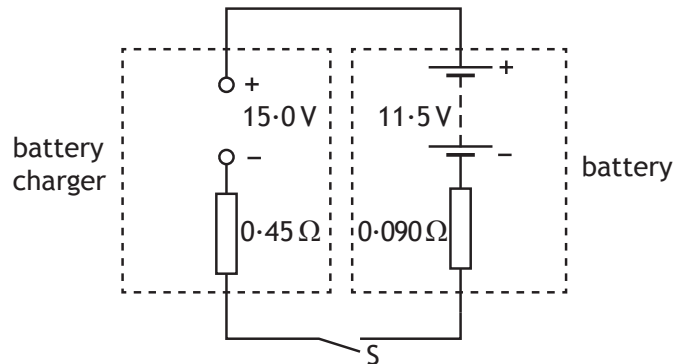

- (A) Switch S is closed.

Calculate the initial charging current.

3

Space for working and answer

- (B) Explain why the charging current decreases as the battery charges.

2



* X 7 5 7 7 6 0 1 2 8 *

Question			Answer	Max Mark	Additional Guidance
10.	(a)	(i)	12.8 J (of energy) <u>is gained</u> by/supplied to 1 coulomb (of charge passing through the battery)	1	
		(ii)	$E = V + Ir$ and $V = IR$ (1) $E = I(R + r)$ $12.8 = I(0.050 + 6.0 \times 10^{-3})$ (1) $I = 230$ A (1)	3	Both required for 1 mark If candidates start with this expression, it gets the formula mark $R_{\text{Total}} = 0.050 + 6.0 \times 10^{-3}$ $= 0.056$ (Ω) $I = E/R_T$ (1) $= 12.8/0.056$ (1) $= 230$ A (1) accept $I = V/R$ if sub correct accept 200, 229, 228.6 Or consistent with (a) (i)
		(iii)	(Wire of large diameter) has a low resistance (1) or to <u>prevent</u> overheating (1) or to <u>prevent</u> wires melting (1)	1	Not: motor requires large current, on its own Not: The wires will melt, on its own. eg wires melt (no justification) 0 marks, <u>thin</u> wires could melt due to large current 1 mark
	(b)	(i)	12.6 V	1	No tolerance
		(ii)	(gradient = $-r$) gradient = $(12 - 12.5)/(60 - 10)$ (1) $= -0.01$ (1) internal resistance = 0.01Ω (1)	3	Gradient = r is wrong physics, award 0 marks gradient formula or implied (1) calculating gradient (1) or $E = V + Ir$ (1) $12.6 = 12 + 60r$ (1) $r = 0.01 \Omega$ (1) If using this method, they must use data from the line or points which lie on the line. Or consistent with (b) (i)

Question		Answer	Max Mark	Additional Guidance
	(iii)	<p>(A)</p> $I = \frac{V}{R} \quad (1)$ $= \frac{(15 - 11.5)}{(0.09 + 0.45)} \quad (1)$ $= 6.5 \text{ A} \quad (1)$	3	Accept 6, 6.48, 6.481
		<p>(B)</p> <p>The e.m.f. of the battery increases (1)</p> <p>Difference between the two e.m.f.s decreases (1)</p>	2	Independent marks Accept voltage or pd in place of emf or equivalent Apply \pm rule

11. A defibrillator is a device that provides a high energy electrical impulse to correct abnormal heart beats.

MARKS DO NOT WRITE IN THIS MARGIN

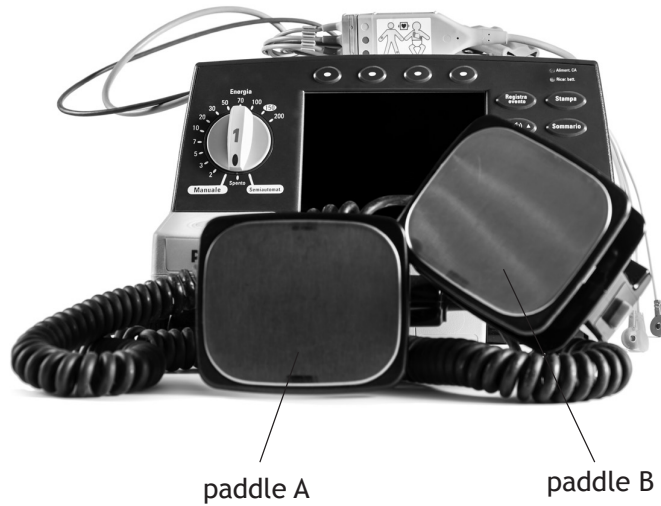

The diagram shows a simplified version of a defibrillator circuit.

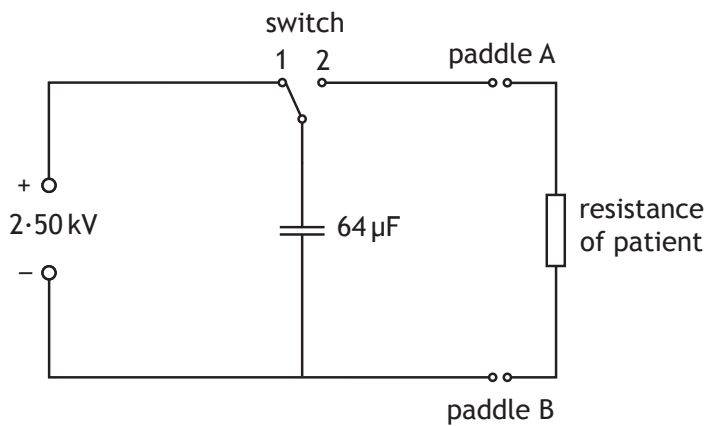

The switch is set to position 1 and the capacitor charges.

- (a) Show the charge on the capacitor when it is fully charged is 0.16 C.

2

Space for working and answer



11. (continued)

MARKS DO NOT WRITE IN THIS MARGIN

(b) Calculate the maximum energy stored by the capacitor.

3

Space for working and answer

(c) To provide the electrical impulse required the capacitor is discharged through the person's chest using the paddles as shown



The initial discharge current through the person is 35.0A.

(i) Calculate the effective resistance of the part of the person's body between the paddles.

3

Space for working and answer



* X 7 5 7 7 6 0 1 3 1 *

MARKS
DO NOT
WRITE IN
THIS
MARGIN

11. (c) (continued)

- (ii) The graph shows how the current between the paddles varies with time during the discharge of the capacitor.

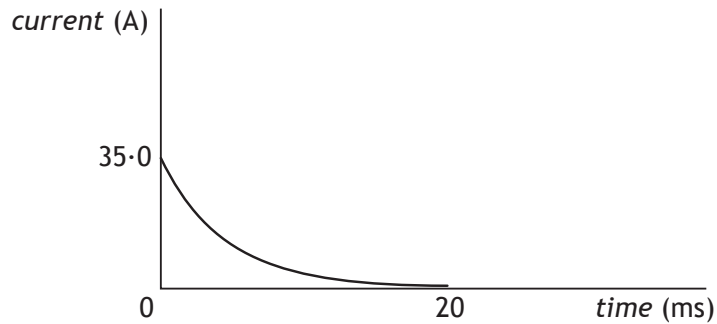

The effective resistance of the person remains the same during this time.

Explain why the current decreases with time.

1

- (iii) The defibrillator is used on a different person with larger effective resistance. The capacitor is again charged to 2.50 kV.

On the graph in (c)(ii) add a line to show how the current in this person varies with time.

(An additional graph, if required, can be found on *Page thirty-eight*).

2



Question		Answer	Max Mark	Additional Guidance	
11.	(a)	$C = \frac{Q}{V} \quad (1)$ $64 \times 10^{-6} = \frac{Q}{2.50 \times 10^3} \quad (1)$ $Q = 0.16(C)$	2	<p>Must start with formula</p> <p>Maximum 1 mark if final answer not shown</p> <p>Note: $C = \frac{Q}{V}$</p> $64 \times 10^{-6} = \frac{Q}{2.50}$ $Q = 0.16$ <p>Is awarded a maximum of 1 mark for the formula, as knowledge of units has not been <u>shown</u>.</p> <p>It is acceptable to work back to find the value of capacitance.</p>	
	(b)	$E = \frac{1}{2} QV \quad (1)$ $E = \frac{1}{2} \times 0.16 \times 2.50 \times 10^3 \quad (1)$ $E = 200\text{J} \quad (1)$	3	<p>Alternative methods:</p> $E = \frac{1}{2} CV^2 \quad (1)$ $= \frac{1}{2} \times 64 \times 10^{-6} \times (2.50 \times 10^3)^2 \quad (1)$ $= 200 \text{ J} \quad (1)$ <p>or</p> $E = \frac{1}{2} \frac{Q^2}{C} \quad (1)$ $= \frac{1}{2} \frac{0.16^2}{64 \times 10^{-6}} \quad (1)$ $= 200 \text{ J} \quad (1)$ <p>Note: max 2 marks if not $\times 10^{-6}$, unless value shown as 0.064×10^{-3}, which is acceptable or answer quoted as $200 \times 10^6 \mu\text{J}$ or similar. (treat as unit error)</p>	
	(c)	(i)	$v = IR \quad (1)$ $2.50 \times 10^3 = 35.0 \times R \quad (1)$ $R = 71.4\Omega \quad (1)$	3	Accept 71, 71.43, 71.429
		(ii)	The voltage decreases (1)	1	

Question		Answer	Max Mark	Additional Guidance
	(iii)	Smaller initial current (1) Time to reach 0 A is longer (1)	2	Line must be a curve to award the second mark Line must tend towards the time axis to gain the second mark. Do not worry about areas under the lines being different.

MARKS
DO NOT
WRITE IN
THIS
MARGIN

12. A student carries out an investigation to determine the refractive index of a prism.

A ray of monochromatic light passes through the prism as shown.

not to scale

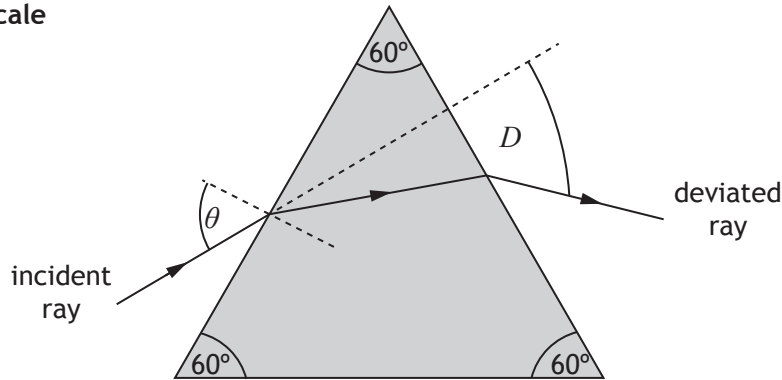

The angle of deviation D is the angle between the direction of the incident ray and the deviated ray.

The student varies the angle of incidence θ and measures the corresponding angles of deviation D .

The results are shown in the table.

Angle of incidence θ ($^{\circ}$)	Angle of deviation D ($^{\circ}$)
30.0	47.0
40.0	38.1
50.0	37.5
60.0	38.8
70.0	42.5

- (a) Using the square-ruled paper on *Page thirty-five*, draw a graph of D against θ . 3
- (b) Using your graph state the two values of θ that produce an angle of deviation of 41.0° . 1
- (c) Using your graph give an estimate of the minimum angle of deviation D_m . 1



12. (continued)

- (d) The refractive index n of the prism can be determined using the relationship.

$$n \sin\left(\frac{A}{2}\right) = \sin\left(\frac{A + D_m}{2}\right)$$

where A is the angle at the top of the prism, and
 D_m is the minimum angle of deviation.

Use this relationship and your answer to (c) to determine the refractive index of the prism.

2

Space for working and answer

- (e) Using the same apparatus, the student now wishes to determine more precisely the minimum angle of deviation.

Suggest two improvements to the experimental procedure that would achieve this.

2

[END OF QUESTION PAPER]



* X 7 5 7 7 6 0 1 3 4 *

Question		Answer	Max Mark	Additional Guidance
12.	(a)	<p>Suitable scales with labels on axes (quantity and units) (1) [Allow for axes starting at zero or broken axes or an appropriate value eg 30°]</p> <p>Correct plotting of points (1)</p> <p>Smooth U shaped curve through these points. (1)</p>	3	<p>Accuracy of plotting should be easily checkable with the scale chosen.</p> <p>If the origin is shown the scale must either be continuous or the axis must be 'broken'. Otherwise maximum 2 marks.</p> <p>Do not penalise if candidates plot θ against D</p> <p>Graphs of sine of angles are incorrect for (a) 0 marks but can still gain marks for rest of question.</p>
	(b)	36° and 66°	1	<p>both required for 1 mark Must be consistent with (a) Allow \pm half box tolerance</p>
	(c)	37°	1	<p>Must be consistent with (a) Allow \pm half box tolerance</p>
	(d)	<p>Correct substitution into equation using D_m from answer to (c) (1)</p> <p>Correct value for n (1.5 if using D_m equal to 37°) (1)</p>	2	<p>Must be consistent with (c)</p>
	(e)	<p>Repeat measurements (1)</p> <p>More measurements around/ close to a minimum or smaller 'steps' in angle (1)</p>	2	<p>Not: take more measurements Repeat the experiment more times Extend the range</p>

[END OF MARKING INSTRUCTIONS]



National
Qualifications
2016

X757/76/02

**Physics
Section 1 — Questions**

TUESDAY, 24 MAY
9:00 AM – 11:30 AM

Instructions for the completion of Section 1 are given on *Page 02* of your question and answer booklet X757/76/01.

Record your answers on the answer grid on *Page 03* of your question and answer booklet.

Reference may be made to the Data Sheet on *Page 02* of this booklet and to the Relationships Sheet X757/76/11.

Before leaving the examination room you must give your question and answer booklet to the invigilator; if you do not, you may lose all the marks for this paper.



* X 7 5 7 7 6 0 2 *

DATA SHEET

COMMON PHYSICAL QUANTITIES

Quantity	Symbol	Value	Quantity	Symbol	Value
Speed of light in vacuum	c	$3.00 \times 10^8 \text{ m s}^{-1}$	Planck's constant	h	$6.63 \times 10^{-34} \text{ J s}$
Magnitude of the charge on an electron	e	$1.60 \times 10^{-19} \text{ C}$	Mass of electron	m_e	$9.11 \times 10^{-31} \text{ kg}$
Universal Constant of Gravitation	G	$6.67 \times 10^{-11} \text{ m}^3 \text{ kg}^{-1} \text{ s}^{-2}$	Mass of neutron	m_n	$1.675 \times 10^{-27} \text{ kg}$
Gravitational acceleration on Earth	g	9.8 m s^{-2}	Mass of proton	m_p	$1.673 \times 10^{-27} \text{ kg}$
Hubble's constant	H_0	$2.3 \times 10^{-18} \text{ s}^{-1}$			

REFRACTIVE INDICES

The refractive indices refer to sodium light of wavelength 589 nm and to substances at a temperature of 273 K.

Substance	Refractive index	Substance	Refractive index
Diamond	2.42	Water	1.33
Crown glass	1.50	Air	1.00

SPECTRAL LINES

Element	Wavelength/nm	Colour	Element	Wavelength/nm	Colour
Hydrogen	656	Red	Cadmium	644	Red
	486	Blue-green		509	Green
	434	Blue-violet		480	Blue
	410	Violet	Lasers		
	397	Ultraviolet	<i>Element</i>	<i>Wavelength/nm</i>	<i>Colour</i>
	389	Ultraviolet	Carbon dioxide	9550 } 10590 }	Infrared
Sodium	589	Yellow	Helium-neon	633	Red

PROPERTIES OF SELECTED MATERIALS

Substance	Density/kg m ⁻³	Melting Point/K	Boiling Point/K
Aluminium	2.70×10^3	933	2623
Copper	8.96×10^3	1357	2853
Ice	9.20×10^2	273
Sea Water	1.02×10^3	264	377
Water	1.00×10^3	273	373
Air	1.29
Hydrogen	9.0×10^{-2}	14	20

The gas densities refer to a temperature of 273 K and a pressure of $1.01 \times 10^5 \text{ Pa}$.

SECTION 1 — 20 marks

Attempt ALL questions

1. A car accelerates uniformly from rest. The car travels a distance of 60 m in 6.0 s. The acceleration of the car is

- A 0.83 m s^{-2}
- B 3.3 m s^{-2}
- C 5.0 m s^{-2}
- D 10 m s^{-2}
- E 20 m s^{-2} .

2. A ball is thrown vertically upwards and falls back to Earth. Neglecting air resistance, which velocity-time graph represents its motion?

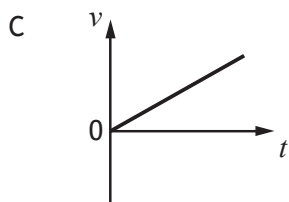
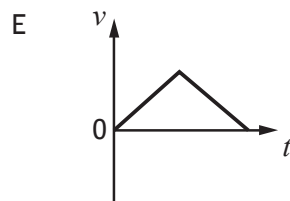
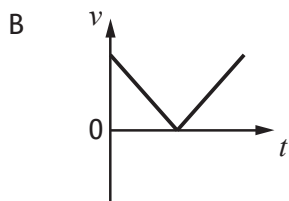
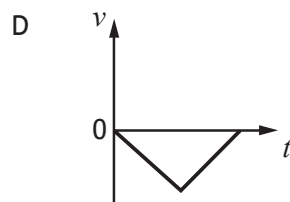
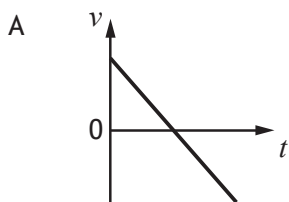

[Turn over

3. A block of wood slides with a constant velocity down a slope. The slope makes an angle of 30° with the horizontal as shown. The mass of the block is 2.0 kg .

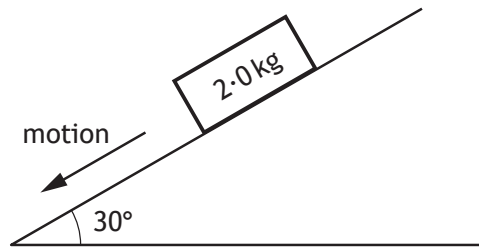

The magnitude of the force of friction acting on the block is

- A 1.0 N
 - B 1.7 N
 - C 9.8 N
 - D 17.0 N
 - E 19.6 N .
4. The graph shows the force which acts on an object over a time interval of 8.0 seconds.

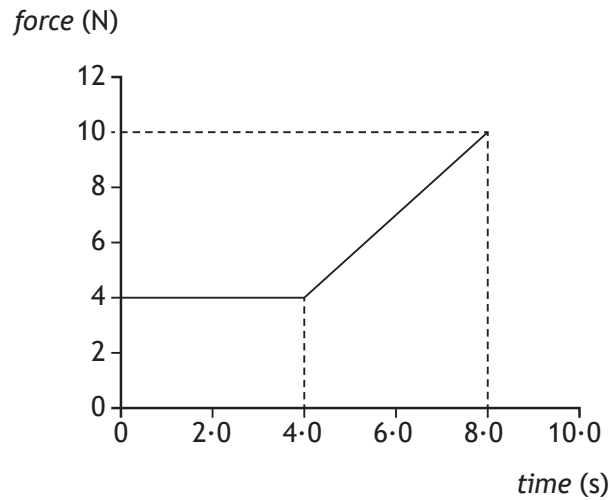

The momentum gained by the object during this 8.0 seconds is

- A 12 kg m s^{-1}
- B 32 kg m s^{-1}
- C 44 kg m s^{-1}
- D 52 kg m s^{-1}
- E 72 kg m s^{-1} .

5. A planet orbits a star at a distance of 3.0×10^9 m.
The star exerts a gravitational force of 1.6×10^{27} N on the planet.
The mass of the star is 6.0×10^{30} kg.
The mass of the planet is
- A 2.4×10^{14} kg
 - B 1.2×10^{16} kg
 - C 3.6×10^{25} kg
 - D 1.6×10^{26} kg
 - E 2.4×10^{37} kg.
6. A car horn emits a sound with a constant frequency of 405 Hz.
The car is travelling away from a student at 28.0 m s^{-1} .
The speed of sound in air is 335 m s^{-1} .
The frequency of the sound from the horn heard by the student is
- A 371 Hz
 - B 374 Hz
 - C 405 Hz
 - D 439 Hz
 - E 442 Hz.

[Turn over

7. The graphs show how the radiation per unit surface area, R , varies with the wavelength, λ , of the emitted radiation for two stars, P and Q.

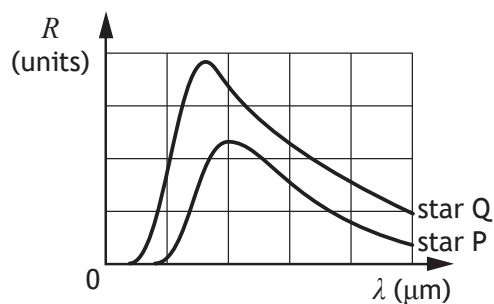

A student makes the following conclusions based on the information in the graph.

- I Star P is hotter than star Q.
- II Star P emits more radiation per unit surface area than star Q.
- III The peak intensity of the radiation from star Q is at a shorter wavelength than that from star P.

Which of these statements is/are correct?

- A I only
 - B II only
 - C III only
 - D I and II only
 - E II and III only
8. One type of hadron consists of two down quarks and one up quark.

The charge on a down quark is $-\frac{1}{3}$.

The charge on an up quark is $+\frac{2}{3}$.

Which row in the table shows the charge and type for this hadron?

	<i>charge</i>	<i>type of hadron</i>
A	0	baryon
B	+1	baryon
C	-1	meson
D	0	meson
E	+1	meson

9. A student makes the following statements about sub-nuclear particles.
- I The force mediating particles are bosons.
 - II Gluons are the mediating particles of the strong force.
 - III Photons are the mediating particles of the electromagnetic force.

Which of these statements is/are correct?

- A I only
 - B II only
 - C I and II only
 - D II and III only
 - E I, II and III
10. The last two changes in a radioactive decay series are shown below.
A Bismuth nucleus emits a beta particle and its product, a Polonium nucleus, emits an alpha particle.

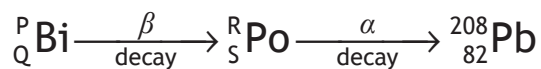

Which numbers are represented by P, Q, R and S?

	P	Q	R	S
A	210	83	208	81
B	210	83	210	84
C	211	85	207	86
D	212	83	212	84
E	212	85	212	84

[Turn over

11. The table below shows the threshold frequency of radiation for photoelectric emission for some metals.

<i>Metal</i>	<i>Threshold frequency (Hz)</i>
sodium	4.4×10^{14}
potassium	5.4×10^{14}
zinc	6.9×10^{14}

Radiation of frequency 6.3×10^{14} Hz is incident on the surface of each of the metals.

Photoelectric emission occurs from

- A sodium only
 - B zinc only
 - C potassium only
 - D sodium and potassium only
 - E zinc and potassium only.
12. Radiation of frequency 9.00×10^{15} Hz is incident on a clean metal surface.
- The maximum kinetic energy of a photoelectron ejected from this surface is 5.70×10^{-18} J.
- The work function of the metal is
- A 2.67×10^{-19} J
 - B 5.97×10^{-18} J
 - C 1.17×10^{-17} J
 - D 2.07×10^{-2} J
 - E 9.60×10^{-1} J.

13. A ray of monochromatic light is incident on a grating as shown.

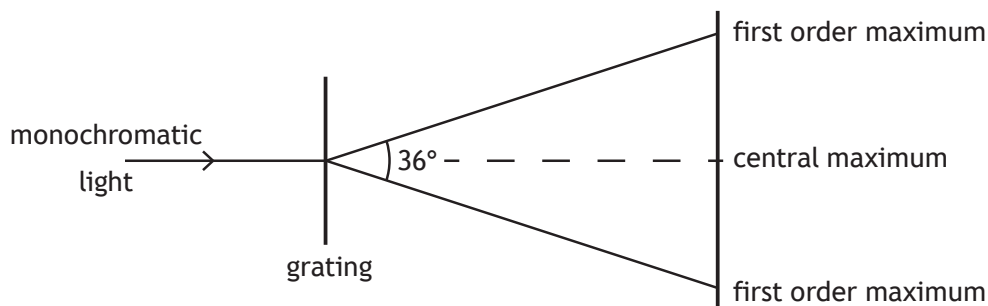

The wavelength of the light is 633 nm.

The separation of the slits on the grating is

- A 1.96×10^{-7} m
 B 1.08×10^{-6} m
 C 2.05×10^{-6} m
 D 2.15×10^{-6} m
 E 4.10×10^{-6} m.
14. Light travels from **glass** into **air**.
 Which row in the table shows what happens to the speed, frequency and wavelength of the light as it travels from glass into air?

	<i>Speed</i>	<i>Frequency</i>	<i>Wavelength</i>
A	decreases	stays constant	decreases
B	decreases	increases	stays constant
C	stays constant	increases	increases
D	increases	increases	stays constant
E	increases	stays constant	increases

15. The irradiance of light from a point source is 32 W m^{-2} at a distance of 4.0 m from the source.

The irradiance of the light at a distance of 16 m from the source is

- A 0.125 W m^{-2}
 B 0.50 W m^{-2}
 C 2.0 W m^{-2}
 D 8.0 W m^{-2}
 E 128 W m^{-2} .

16. Part of the energy level diagram for an atom is shown

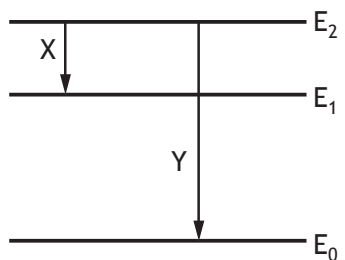

X and Y represent two possible electron transitions.

A student makes the following statements about transitions X and Y.

- I Transition Y produces photons of higher frequency than transition X
- II Transition X produces photons of longer wavelength than transition Y
- III When an electron is in the energy level E_0 , the atom is ionised.

Which of the statements is/are correct?

- A I only
- B I and II only
- C I and III only
- D II and III only
- E I, II and III

17. The output of a signal generator is connected to the input of an oscilloscope. The trace produced on the screen of the oscilloscope is shown.

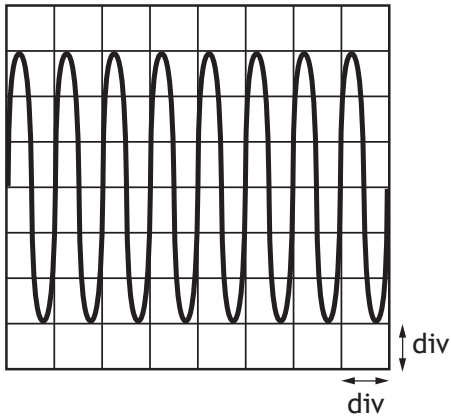

The timebase control of the oscilloscope is set at 2 ms/div.

The Y-gain control of the oscilloscope is set at 4 mV/div.

Which row in the table shows the frequency and peak voltage of the output of the signal generator?

	<i>frequency (Hz)</i>	<i>peak voltage (mV)</i>
A	0.5	12
B	0.5	6
C	250	6
D	500	12
E	500	24

[Turn over

18. A potential divider circuit is set up as shown.

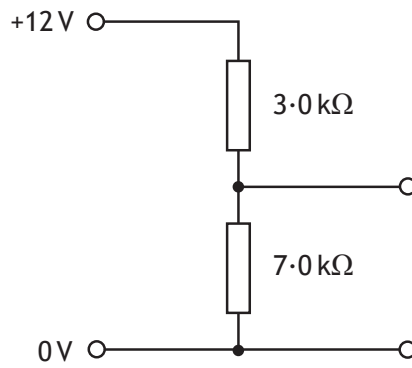

The potential difference across the 7.0 kΩ resistor is

- A 3.6 V
- B 4.0 V
- C 5.1 V
- D 8.4 V
- E 9.0 V.

19. A circuit is set up as shown.

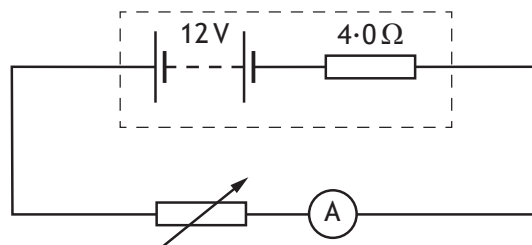

The resistance of the variable resistor is increased and corresponding readings on the ammeter are recorded.

Resistance (Ω)	2.0	4.0	6.0	8.0
Current (A)	2.0	1.5	1.2	1.0

These results show that as the resistance of the variable resistor increases the power dissipated in the variable resistor

- A increases
 - B decreases
 - C remains constant
 - D decreases and then increases
 - E increases and then decreases.
20. A $20\ \mu\text{F}$ capacitor is connected to a 12 V d.c. supply.
The maximum charge stored on the capacitor is

- A $1.4 \times 10^{-3}\ \text{C}$
- B $2.4 \times 10^{-4}\ \text{C}$
- C $1.2 \times 10^{-4}\ \text{C}$
- D $1.7 \times 10^{-6}\ \text{C}$
- E $6.0 \times 10^{-7}\ \text{C}$.

[END OF SECTION 1. NOW ATTEMPT THE QUESTIONS IN SECTION 2
OF YOUR QUESTION AND ANSWER BOOKLET]

Marking Instructions for each question**Section 1**

Question	Answer	Max Mark
1.	B	1
2.	A	1
3.	C	1
4.	C	1
5.	C	1
6.	B	1
7.	C	1
8.	A	1
9.	E	1
10.	D	1
11.	D	1
12.	A	1
13.	C	1
14.	E	1
15.	C	1
16.	B	1
17.	D	1
18.	D	1
19.	E	1
20.	B	1

FOR OFFICIAL USE



--	--	--	--	--	--

National
Qualifications
2016

Mark

--

X757/76/01

**Physics
Section 1 — Answer Grid
and Section 2**

TUESDAY, 24 MAY
9:00 AM – 11:30 AM



Fill in these boxes and read what is printed below.

Full name of centre

Town

--

Forename(s)

Surname

Number of seat

--

--

--

Date of birth

Day

Month

Year

Scottish candidate number

--	--

--	--

--	--

--	--	--	--	--	--	--	--	--	--

Total marks — 130

SECTION 1 — 20 marks

Attempt ALL questions.

Instructions for the completion of Section 1 are given on *Page 02*.

SECTION 2 — 110 marks

Attempt ALL questions.

Reference may be made to the Data Sheet on *Page 02* of the question paper X757/76/02 and to the Relationships Sheet X757/76/11.

Care should be taken to give an appropriate number of significant figures in the final answers to calculations.

Write your answers clearly in the spaces provided in this booklet. Additional space for answers and rough work is provided at the end of this booklet. If you use this space you must clearly identify the question number you are attempting. Any rough work must be written in this booklet. You should score through your rough work when you have written your final copy.

Use **blue** or **black** ink.

Before leaving the examination room you must give this booklet to the Invigilator; if you do not, you may lose all the marks for this paper.



SECTION 2 — 110 marks
Attempt ALL questions

1.

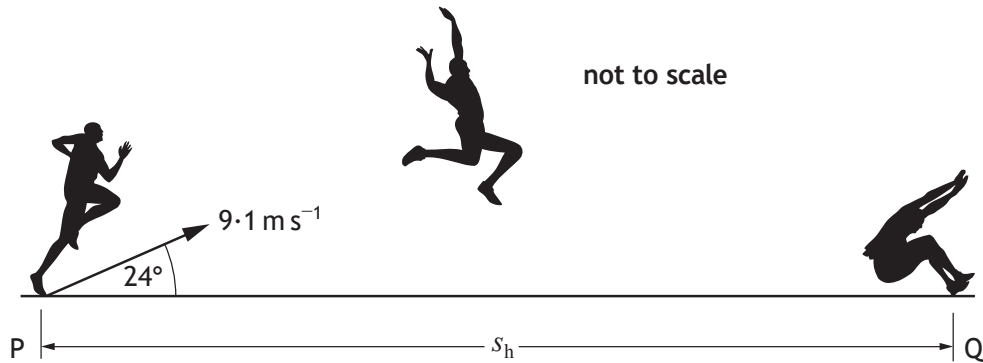

An athlete takes part in a long jump competition. The athlete takes off from point P with an initial velocity of 9.1 m s^{-1} at an angle of 24° to the horizontal and lands at point Q.

(a) Calculate:

- (i) the vertical component of the initial velocity of the athlete;

1

Space for working and answer

- (ii) the horizontal component of the initial velocity of the athlete.

1

Space for working and answer



* X 7 5 7 7 6 0 1 0 6 *

1. (continued)

(b) Show that the time taken for the athlete to travel from P to Q is 0.76 s. 2
Space for working and answer

(c) Calculate the horizontal displacement s_h between points P and Q. 3
Space for working and answer

(d) The graph shows how the horizontal displacement of the athlete varies with time for this jump when air resistance is ignored.

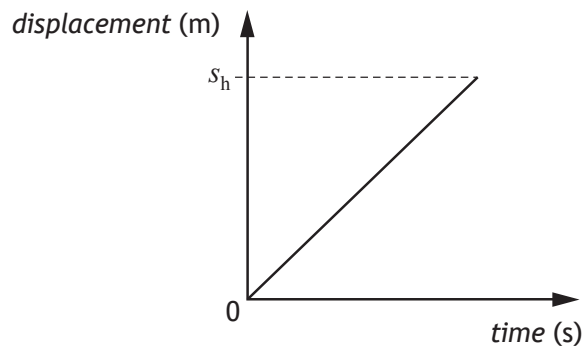

Add a line to the graph to show how the horizontal displacement of the athlete varies with time when air resistance is taken into account. 2

(An additional graph, if required can be found on Page 38)



Section 2

Question			Answer	Max Mark	Additional Guidance
1.	(a)	(i)	$u_v = 9.1 \sin 24^\circ$ $u_v = 3.7 \text{ m s}^{-1}$ (1)	1	Sig figs: Accept 4, 3.70, 3.701 OR Accept m/s
		(ii)	$u_h = 9.1 \cos 24^\circ$ $u_h = 8.3 \text{ m s}^{-1}$ (1)	1	Sig figs: Accept 8, 8.31, 8.313
	(b)		$v = u + at$ (1) $0 = 3.7 + (-9.8)t$ $t = 0.378 \text{ (s)}$ (total) $t = 0.378 \times 2$ (1) (total) $t = 0.76 \text{ s}$ OR $v = u + at$ (1) $-3.7 = 3.7 + (-9.8) \times t$ (1) (total) $t = 0.76 \text{ s}$	2	SHOW question. Sign convention must be correct. Accept $0 = 3.7 - 9.8t$ If final line not shown then a maximum of 1 mark can be awarded. Guidance on alternatives $s = ut + \frac{1}{2}at^2$ (1) $0 = 3.7t + \frac{1}{2}(-9.8)t^2$ (1) (total) $t = 0.76 \text{ s}$
	(c)		$s = v_h \times t$ (1) $s = 8.3 \times 0.76$ (1) $s = 6.3 \text{ m}$ (1)	3	Or consistent with (a)(ii) Sig figs: Accept 6, 6.31, 6.308 Accept $s = \frac{1}{2}(u + v)t$ Accept $s = ut + \frac{1}{2}at^2$ Accept $s = ut$ $v_h = 8.31 \text{ m s}^{-1}$ gives $s = 6.32 \text{ m}$ is acceptable
	(d)		Smaller displacement (1) curve with decreasing gradient (1)	2	Ignore any change in time Any part of the curve drawn above the original line - award 0 marks These marks are independent.

2. A student uses the apparatus shown to investigate the force of friction between the wheels of a toy car and a carpet.

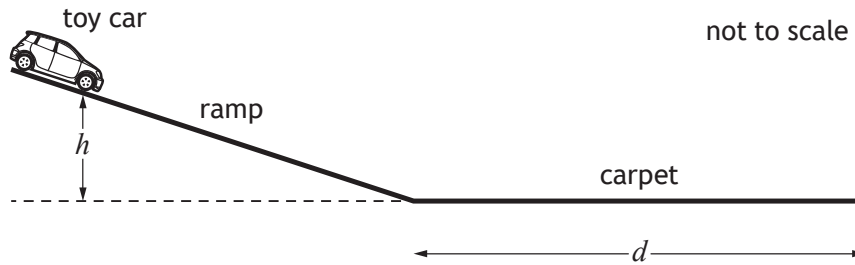

The toy car is released from rest, from a height h . It then travels down the ramp and along the carpet before coming to rest. The student measures the distance d that the car travels along the carpet.

The student repeats the procedure several times and records the following measurements and uncertainties.

Mass of car, m : (0.20 ± 0.01) kg

Height, h : (0.40 ± 0.005) m

Distance, d : 1.31 m 1.40 m 1.38 m 1.41 m 1.35 m

- (a) (i) Calculate the mean distance d travelled by the car.

1

Space for working and answer

- (ii) Calculate the approximate random uncertainty in this value.

2

Space for working and answer



* X 7 5 7 7 6 0 1 0 8 *

2. (continued)

- (b) Determine which of the quantities; mass m , height h or mean distance d , has the largest percentage uncertainty.

You must justify your answer by calculation.

Space for working and answer

4

- (c) (i) Calculate the potential energy of the toy car at height h .
An uncertainty in this value is not required.

Space for working and answer

3

[Turn over



* X 7 5 7 7 6 0 1 0 9 *

2. (c) (continued)

MARKS DO NOT WRITE IN THIS MARGIN

(ii) Calculate the average force of friction acting between the toy car and carpet, as the car comes to rest.

An uncertainty in this value is not required.

Space for working and answer

3

(iii) State one assumption you have made in (c) (ii).

1



Question			Answer	Max Mark	Additional Guidance
2.	(a)	(i)	$\bar{d} = \frac{1.31+1.40+1.38+1.41+1.35}{5}$ $\bar{d} = 1.37 \text{ m} \quad (1)$	1	Sig figs: Accept 1.4, 1.370
		(ii)	$\Delta\bar{d} = \frac{1.41-1.31}{5} \quad (1)$ $\Delta\bar{d} = 0.02 \text{ m} \quad (1)$	2	Sig figs: Accept 0.020 Accept $(1.37 \pm 0.02)\text{m}$
	(b)		$\% \Delta m = \frac{0.01}{0.20} \times 100 = 5\% \quad (1)$ $\% \Delta h = \frac{0.005}{0.40} \times 100 = 1.3\% \quad (1)$ $\% \Delta \bar{d} = \frac{0.02}{1.37} \times 100 = 1.5\% \quad (1)$ <p>Mass (has largest percentage uncertainty). (1)</p>	4	<p>Or consistent with (a)(i) and (a)(ii).</p> <p>Each correct calculation <u>with correct substitution</u> is awarded 1 mark</p> <p>Each calculation is independent but must have all three calculations <u>shown</u> to access the final mark for the conclusion.</p> <p>Accept percentage sign missing.</p> <p>Wrong substitution - maximum of 2 marks.</p> <p>Sig figs: for $\% \Delta m$ Accept 5.0, 5.00 for $\% \Delta h$ Accept 1, 1.25, 1.250 for $\% \Delta \bar{d}$ Accept 1, 1.46, 1.460</p>
	(c)	(i)	$E_p = mgh \quad (1)$ $E_p = 0.20 \times 9.8 \times 0.40 \quad (1)$ $E_p = 0.78 \text{ J} \quad (1)$	3	Sig figs: Accept 0.8, 0.784 Treat -9.8 as wrong substitution unless h is also negative.

Question			Answer	Max Mark	Additional Guidance
2.	(c)	(ii)	$E_w = Fd$ (1) $0.78 = F \times 1.37$ (1) $F = 0.57 \text{ N}$ (1)	3	Or consistent with (a)(i) and (c)(i) Sig figs: Accept 0.6, 0.569, 0.5693 Candidates can arrive at this answer by alternative methods eg equating loss in E_p to gain in E_k etc. If alternative methods used, can also accept 0.572, 0.5723 1 for ALL equations 1 for ALL substitutions 1 for correct answer
		(iii)	All E_p converted to E_k All E_p converted to E_w Air resistance is negligible Ramp is frictionless Bearings in the wheels are frictionless The carpet is horizontal No energy/heat loss <u>on the ramp</u> etc	1	Only one correct statement required Note the \pm rule applies Energy is conserved on its own OR No energy/ heat loss on its own – 0 marks

3. The following apparatus is set up to investigate the law of conservation of linear momentum.

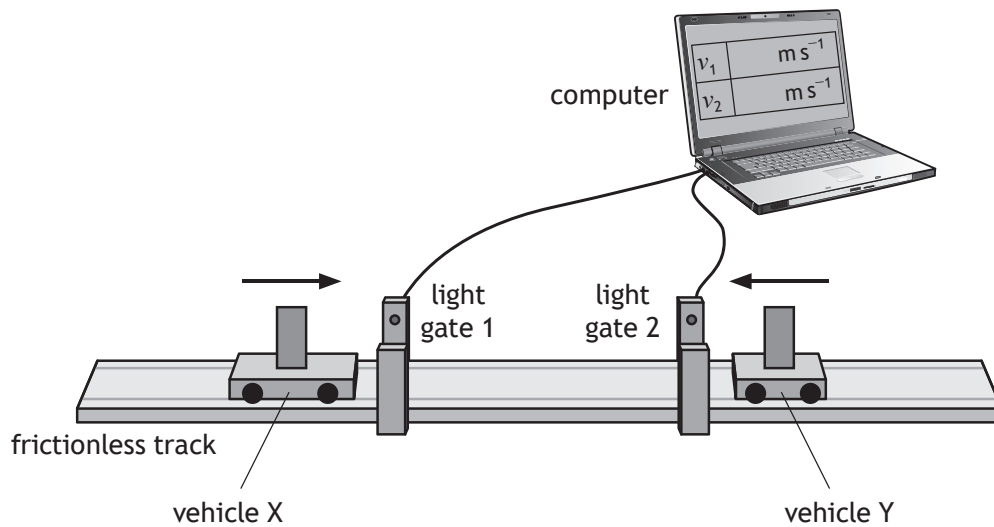

In one experiment, vehicle X is travelling to the right along the track and vehicle Y is travelling to the left along the track.

The vehicles collide and stick together.

The computer displays the speeds of each vehicle before the collision.

The following data are recorded:

Mass of vehicle X = 0.85 kg

Mass of vehicle Y = 0.25 kg

Speed of vehicle X before the collision = 0.55 m s^{-1}

Speed of vehicle Y before the collision = 0.30 m s^{-1}

- (a) State the law of conservation of linear momentum. 1
- (b) Calculate the velocity of the vehicles immediately after the collision. 3
Space for working and answer



3. (continued)

- (c) Show by calculation that the collision is inelastic.
Space for working and answer

MARKS

DO NOT
WRITE IN
THIS
MARGIN

4

[Turn over



Question		Answer	Max Mark	Additional Guidance
3.	(a)	<u>Total</u> momentum before (a collision) is equal to the <u>total</u> momentum after (a collision) in the absence of external forces (1)	1	Not: TMB = TMA An isolated system is equivalent to the absence of external forces
	(b)	$m_1u_1 + m_2u_2 = (m_1 + u_2)v \quad (1)$ $(0.85 \times 0.55) + (0.25 \times -0.3)$ $= (0.25 + 0.85)v \quad (1)$ $v = 0.36 \text{ m s}^{-1} \quad (1)$	3	Sign of the answer must be consistent with the substitution of + and – velocities. Sig figs: Accept 0.4, 0.357, 0.3568 If candidate then goes on to state a direction which is not consistent with their substitution then maximum two marks can be awarded. Where candidates calculate the momentum of each trolley individually both before and after, no marks are awarded unless correct addition (including sign convention) <u>and</u> equating takes place.
	(c)	$E_k = \frac{1}{2}mv^2 \quad \text{ANYWHERE} \quad (1)$ <p>Before $E_k = \frac{1}{2}m_xv_x^2 + \frac{1}{2}m_yv_y^2$</p> $= (\frac{1}{2} \times 0.85 \times 0.55^2)$ $+ (\frac{1}{2} \times 0.25 \times 0.3^2)$ $= 0.14 \text{ (J)} \quad (1)$ <p>After $E_k = \frac{1}{2}mv^2$</p> $= \frac{1}{2} \times 1.1 \times 0.36^2 = 0.071 \text{ (J)} \quad (1)$ <p><u>Kinetic</u> energy is lost. (Therefore inelastic.) (1)</p>	4	Or consistent with (b) 1 mark for both substitutions If candidate answers 0.49 in (b), this gives 0.13 J for E_k after. $E_{k, \text{before}} \neq E_{k, \text{after}}$ is insufficient

4. Two physics students are in an airport building on their way to visit CERN.
- (a) The first student steps onto a moving walkway, which is travelling at 0.83 m s^{-1} relative to the building. This student walks along the walkway at a speed of 1.20 m s^{-1} relative to the walkway.

The second student walks alongside the walkway at a speed of 1.80 m s^{-1} relative to the building.

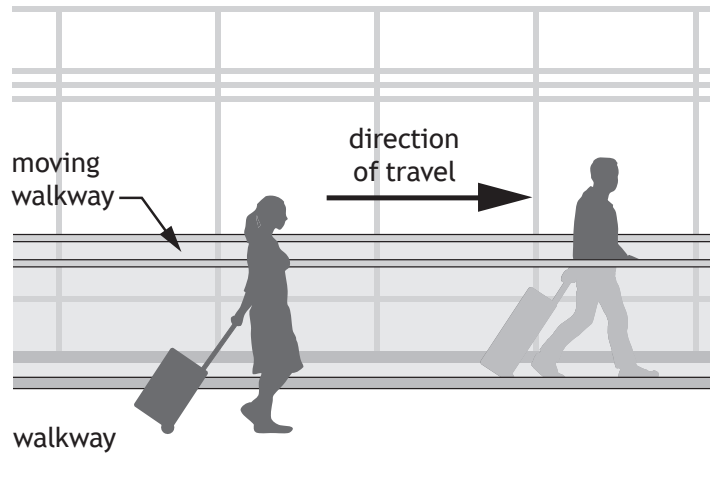

Determine the speed of the first student relative to the second student.
Space for working and answer

2



4. (continued)

(b) On the plane, the students discuss the possibility of travelling at relativistic speeds.

(i) The students consider the plane travelling at $0.8c$ relative to a stationary observer. The plane emits a beam of light towards the observer.

State the speed of the emitted light as measured by the observer.

Justify your answer.

2

(ii) According to the manufacturer, the length of the plane is 71 m.

Calculate the length of the plane travelling at $0.8c$ as measured by the stationary observer.

3

Space for working and answer

(iii) One of the students states that the clocks on board the plane will run slower when the plane is travelling at relativistic speeds.

Explain whether or not this statement is correct.

1

[Turn over



Question		Answer	Max Mark	Additional Guidance
4.	(a)	$(0.83 + 1.20) - 1.80$ (1) 0.23 m s^{-1} (1)	2	
	(b) (i)	$3 \times 10^8 \text{ m s}^{-1}$ or c (1) Speed of light is the same for all observers / all (inertial) frames of reference or equivalent (1)	2	Look for this statement first - if incorrect then 0 marks. $3 \times 10^8 \text{ m s}^{-1}$ or c on its own is worth 1 mark If the numerical value for speed is given, then unit is required- otherwise 0 marks Any wrong physics in justification then maximum 1 mark for the statement
	(ii)	$l' = l \sqrt{1 - \left(\frac{v}{c}\right)^2}$ (1) $l = 71 \sqrt{1 - 0.8^2}$ (1) $l = 43 \text{ m}$ (1)	3	Sig figs: Accept 40, 42.6, 42.60
	(iii)	Correct - from the perspective of the stationary observer there will be time dilation Incorrect - from the perspective of the students they are in the same frame of reference as the clock Not possible to say/could be both correct and incorrect - frame of reference has not been defined	1	The response must involve a statement referring to, or implying, a frame of reference

5. (a) A student is using an elastic band to model the expansion of the Universe.

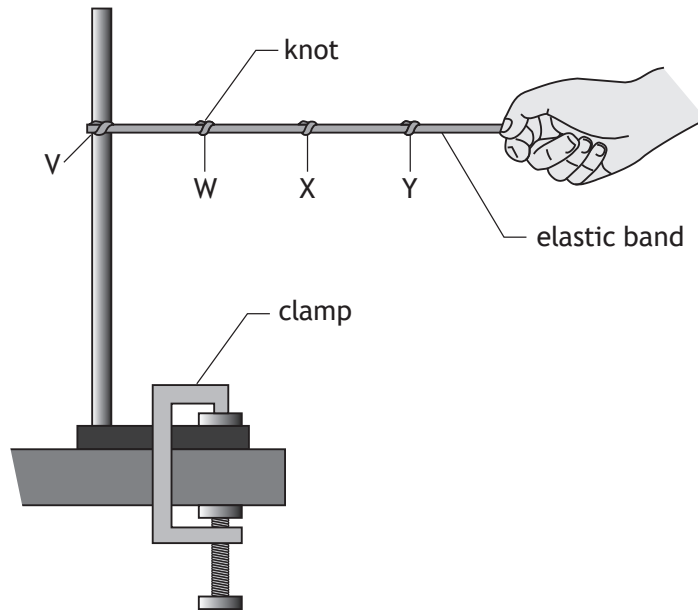

One end of the band is fixed in a clamp stand at V. Knots are tied in the band to represent galaxies. The knots are at regular intervals of 0.10 m, at points W, X and Y as shown.

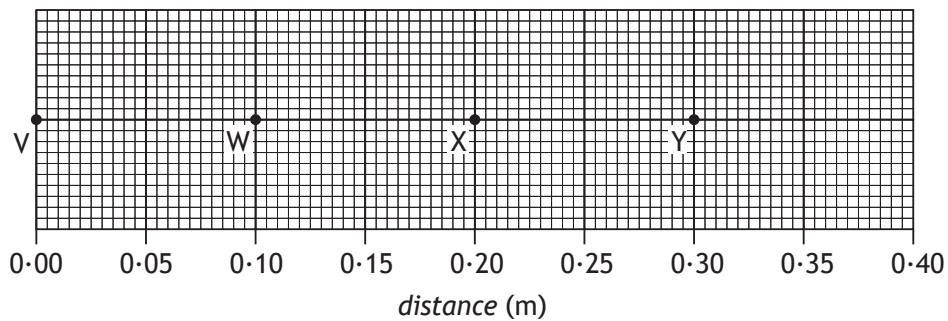

The other end of the elastic band is pulled slowly for 2.5 seconds, so that the band stretches. The knots are now in the positions shown below.

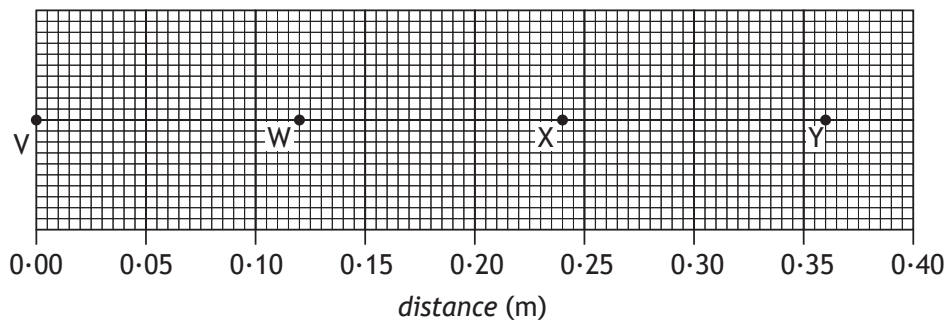

5. (a) (continued)

- (i) Complete the table to show the average speeds of the knots X and Y. 2

<i>Knot</i>	<i>Average speed (m s⁻¹)</i>
W	0.008
X	
Y	

Space for working

- (ii) Explain why this model is a good simulation of the expansion of the Universe. 1

[Turn over



* X 7 5 7 7 6 0 1 1 7 *

5. (continued)

- (b) When viewed from the Earth, the continuous emission spectrum from the Sun has a number of dark lines. One of these lines is at a wavelength of 656 nm.



In the spectrum of light from a distant galaxy, the corresponding dark line is observed at 667 nm.

Calculate the redshift of the light from the distant galaxy.

3

Space for working and answer



Question	Answer	Max Mark	Additional Guidance
----------	--------	----------	---------------------

5.	(a)	(i)	$\Delta X = 0.04 \text{ (m)}$ $X = 0.016 \text{ (m s}^{-1}\text{)}$ (1) $\Delta Y = 0.06 \text{ (m)}$ $Y = 0.024 \text{ (m s}^{-1}\text{)}$ (1)	2	If values are not entered in the table, then X and Y must be identified <u>and</u> units required.
		(ii)	More distant <u>galaxies</u> are moving <u>away</u> at a greater velocity/ have a greater recessional velocity Or equivalent	1	The (average) speed (of the knots) is (directly) <u>proportional</u> to the distance (from V) Any reference to planets or stars alone - 0 marks
	(b)		$z = \frac{\lambda_{\text{observed}} - \lambda_{\text{rest}}}{\lambda_{\text{rest}}} \quad (1)$ $z = \frac{667 \times 10^{-9} - 656 \times 10^{-9}}{656 \times 10^{-9}} \quad (1)$ $z = 0.0168 \quad (1)$	3	Sig figs: Accept 0.017, 0.01677, 0.016768 Accept $z = \frac{667 - 656}{656}$

MARKS

DO NOT
WRITE IN
THIS
MARGIN

6. A website states “Atoms are like tiny solar systems with electrons orbiting a nucleus like the planets orbit the Sun”.

Use your knowledge of physics to comment on this statement.

3

[Turn over



7. An experiment is set up to investigate the behaviour of electrons in electric fields.

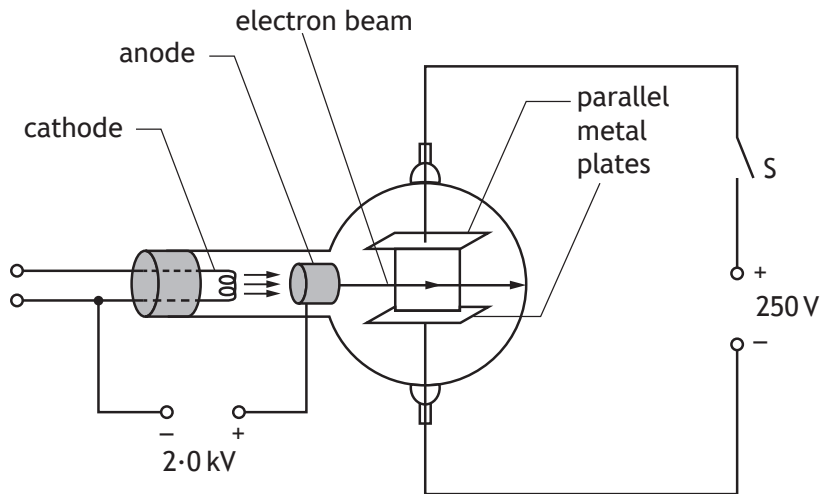

- (a) Electrons are accelerated from rest between the cathode and the anode by a potential difference of 2.0 kV.

Calculate the kinetic energy gained by each electron as it reaches the anode.

3

Space for working and answer

- (b) The electrons then pass between the two parallel metal plates.

The electron beam current is 8.0 mA.

Determine the number of electrons passing between the metal plates in one minute.

4

Space for working and answer



* X 7 5 7 7 6 0 1 2 0 *

7. (continued)

(c) The switch S is now closed.

The potential difference between the metal plates is 250 V.

The path of the electron beam between the metal plates is shown.

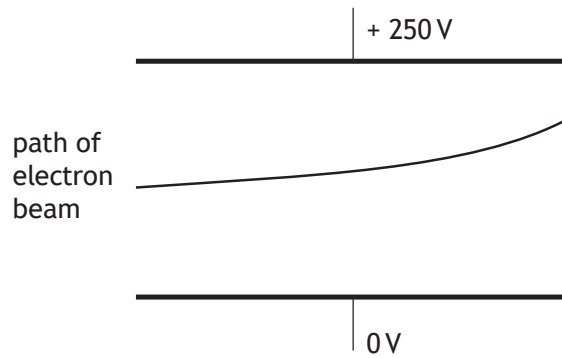

Complete the diagram to show the electric field pattern between the two metal plates.

1

(An additional diagram, if required, can be found on *Page 38*.)

[Turn over



Question		Answer	Max Mark	Additional Guidance
7.	(a)	$W = QV$ (1) $= 1.6 \times 10^{-19} \times 2000$ (1) $= 3.2 \times 10^{-16} \text{ J}$ (1)	3	Sig figs: Accept 3×10^{-16} , 3.20×10^{-16} , 3.200×10^{-16} , Ignore negative sign for charge.
	(b)	$Q = It$ (1) $= 0.008 \times 60$ (1) $= 0.48 \text{ (C)}$ (1) $\text{number} = \frac{0.48}{1.6 \times 10^{-19}}$ $= 3.0 \times 10^{18}$ (1)	4	Sig figs: Accept 3×10^{18} If the response stops at 0.48 then a correct unit is required. Candidates can arrive at this answer by alternative methods eg $P=IV$ and $E=Pt$ OR $Q=It$ to calculate the time for 1 electron.
	(c)	Straight lines with arrows pointing downwards.	1	spacing should be approximately equal (ignore end effect) Field lines must start and finish on the plates Lines at right angles to the plates

8. The diagram shows part of an experimental fusion reactor.

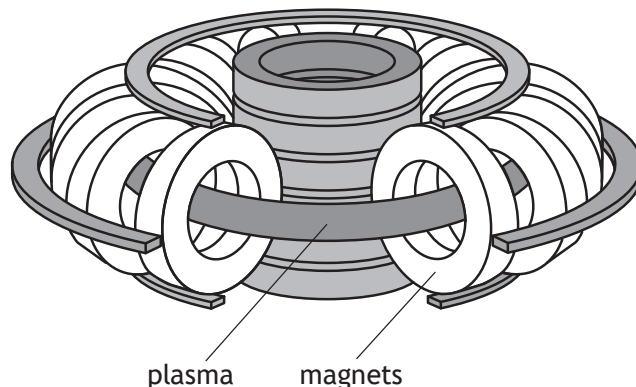

The following statement represents a reaction that takes place inside the reactor.

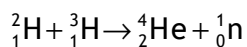

The masses of the particles involved in the reaction are shown in the table.

Particle	Mass (kg)
${}^2_1\text{H}$	3.3436×10^{-27}
${}^3_1\text{H}$	5.0083×10^{-27}
${}^4_2\text{He}$	6.6465×10^{-27}
${}^1_0\text{n}$	1.6749×10^{-27}

- (a) Explain why energy is released in this reaction. 1
- (b) Calculate the energy released in this reaction. 4
Space for working and answer



8. (continued)

- (c) Magnetic fields are used to contain the plasma inside the fusion reactor.
Explain why it is necessary to use a magnetic field to contain the plasma. 1

- (d) The plasma consists of charged particles. A positively charged particle enters a region of the magnetic field as shown.

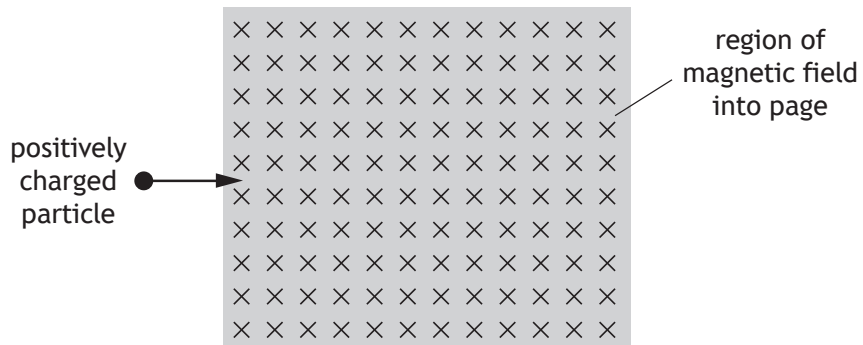

- Determine the direction of the force exerted by the magnetic field on the positively charged particle as it enters the field. 1

[Turn over



Question		Answer	Max Mark	Additional Guidance
8.	(a)	mass is converted into energy	1	There must be a link between mass and energy. Mass is lost on its own - 0 marks Mass defect is wrong physics - 0 marks Energy is released or equivalent is not sufficient.
	(b)	$m_{\text{before}} = 3.3436 \times 10^{-27} + 5.0083 \times 10^{-27}$ $= 8.3519 \times 10^{-27} \text{ (kg)}$ $m_{\text{after}} = 6.6465 \times 10^{-27} + 1.6749 \times 10^{-27}$ $= 8.3214 \times 10^{-27} \text{ (kg)}$ $\Delta m = 3.0500 \times 10^{-29} \text{ (kg)} \quad (1)$ $E = mc^2 \quad (1)$ $= 3.0500 \times 10^{-29} \times (3.00 \times 10^8)^2 \quad (1)$ $= 2.75 \times 10^{-12} \text{ J} \quad (1)$	4	$E = mc^2$ anywhere - 1 mark. If mass before and after not used to 5 significant figures from table then stop marking - maximum 1 mark for formula Arithmetic mistake can be carried forward Truncation error in mass before and/or mass after- maximum 1 mark for formula Sig figs: 2.7, 2.745, 2.7450 If finding $E = mc^2$ for each particle, then $E = mc^2 \quad (1)$ All substitutions (1) Subtraction (1) Final answer (1)
	(c)	Plasma would cool down if it came too close to the sides (and reaction would stop)	1	(Reaction requires very high temperature), so plasma would melt the sides of the reactor OR High temperature plasma could damage/ destroy the container
	(d)	Up the page	1	Accept up and upwards Arrow drawn pointing up the page is acceptable If upwards arrow is drawn on the original diagram, it must be on the left hand edge The path of the particle on its own is not acceptable

MARKS
DO NOT
WRITE IN
THIS
MARGIN

9. A student carries out an experiment to measure the wavelength of microwave radiation. Microwaves pass through two gaps between metal plates as shown.

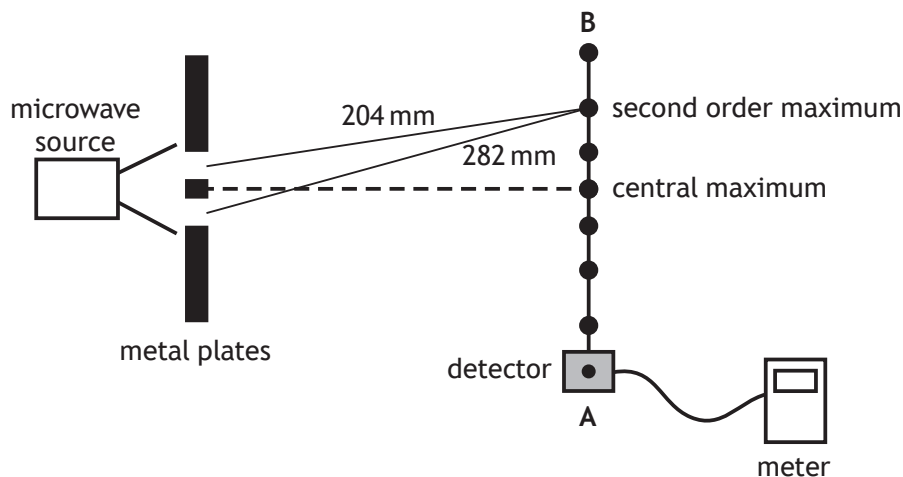

As the detector is moved from A to B, a series of maxima and minima are detected.

- (a) The microwaves passing through the gaps are coherent.
State what is meant by the term *coherent*. 1
- (b) Explain, in terms of waves, how a maximum is produced. 1
- (c) The measurements of the distance from each gap to the second order maximum are shown in the diagram above.
Calculate the wavelength of the microwaves. 3
Space for working and answer



MARKS

DO NOT
WRITE IN
THIS
MARGIN

9. (continued)

(d) The distance separating the two gaps is now increased.

State what happens to the path difference to the second order maximum.

Justify your answer.

2

[Turn over



* X 7 5 7 7 6 0 1 2 5 *

Question		Answer	Max Mark	Additional Guidance
9.	(a)	The waves from the two sources have a constant phase relationship (and have the same frequency, wavelength, and velocity).	1	“In phase” is not sufficient
	(b)	<p>Waves <u>meet</u> in phase</p> <p>OR Crest <u>meets</u> crest</p> <p>OR Trough <u>meets</u> trough</p> <p>OR Path difference = $m\lambda$</p>	1	<p>Accept peak for crest</p> <p>Can be shown by diagram eg</p>  <p>Diagram must imply addition of two waves in phase</p>
	(c)	<p>Path Difference = $m\lambda$ (1)</p> <p>$0.282 - 0.204 = 2 \times \lambda$ (1)</p> <p>$\lambda = 0.0390\text{m}$ (1) (39 mm)</p>	3	<p>Sig figs: 0.039 m 0.03900 m 0.039000 m</p> <p>Not: 0.04 m</p>
	(d)	<p>The path difference stays the same</p> <p>OR</p> <p>The path difference is still 2λ (1)</p> <p>because the wavelength has not changed (1)</p>	2	<p>Look for this statement first - if incorrect then 0 marks.</p> <p>The path difference stays the same OR The path difference is still 2λ on its own - 1 mark</p> <p>Any wrong physics in justification then maximum 1 mark (for the statement)</p>

10. Retroflective materials reflect light to enhance the visibility of clothing.



One type of retroflective material is made from small glass spheres partially embedded in a silver-coloured surface that reflects light.

A ray of monochromatic light follows the path shown as it enters one of the glass spheres.

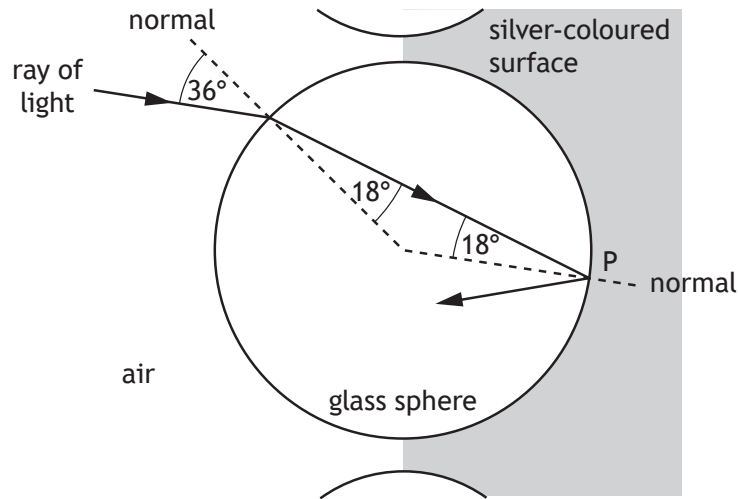

- (a) Calculate the refractive index of the glass for this light.
Space for working and answer

3



10. (continued)

- (b) Calculate the critical angle for this light in the glass.
Space for working and answer

3

- (c) The light is reflected at point P.

Complete the diagram below to show the path of the ray as it passes through the sphere and emerges into the air.

1

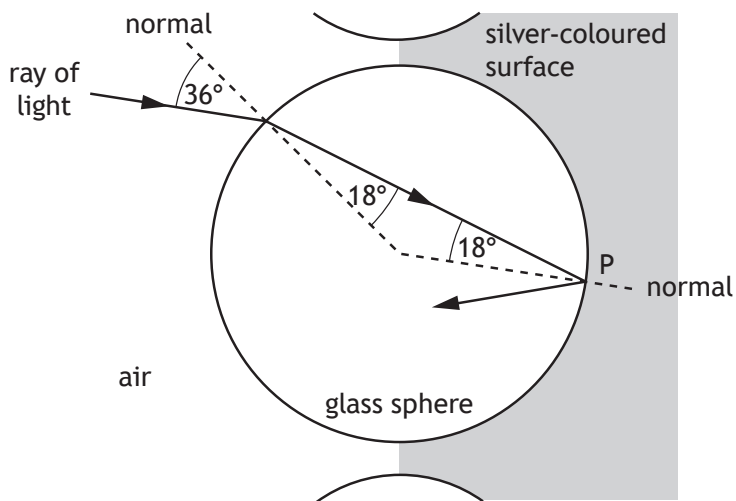

(An additional diagram, if required, can be found on Page 38.)

[Turn over



Question		Answer	Max Mark	Additional Guidance
10.	(a)	$n = \sin i / \sin r$ (1) $= \sin 36 / \sin 18$ (1) $= 1.9$ (1)	3	Sig figs: Accept 2, 1.90, 1.902
	(b)	$\sin \theta_c = 1/n$ (1) $= 1/1.9$ (1) $= 0.5263$ $\theta_c = 32^\circ$ (1)	3	Or consistent with 10(a).
	(c)	Completed diagram, showing light emerging (approximately) parallel to the incident ray	1	The normal is not required

11. A student is describing how the following circuit works.

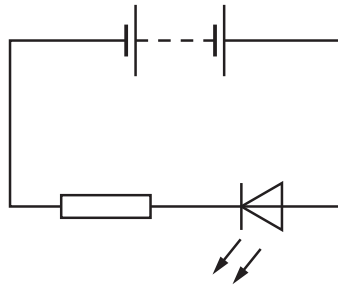

The student states:

“The electricity comes out of the battery with energy and flows through the resistor using up some of the energy, it then goes through the LED and the rest of the energy is changed into light waves.”

Use your knowledge of physics to comment on this statement.

3



* X 7 5 7 7 6 0 1 2 8 *

12. A technician sets up a circuit as shown, using a car battery and two identical lamps.

The battery has an e.m.f. of 12.8 V and an internal resistance of $0.10\ \Omega$.

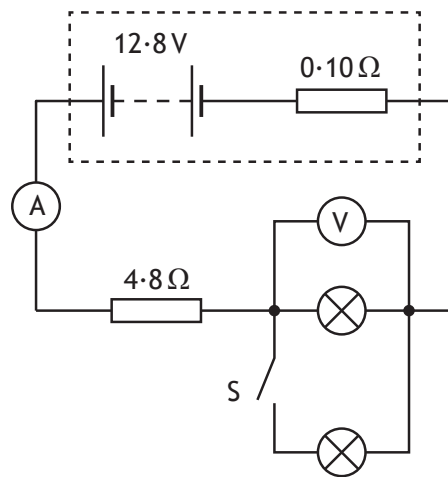

- (a) Switch S is open. The reading on the ammeter is 1.80 A .

- (i) Determine the reading on the voltmeter.

4

Space for working and answer

- (ii) Switch S is now closed.

State the effect this has on the reading on the voltmeter.

Justify your answer.

3



12. (continued)

MARKS

DO NOT
WRITE IN
THIS
MARGIN

(b) Some cars use LEDs in place of filament lamps.

An LED is made from semiconductor material that has been doped with impurities to create a p-n junction.

The diagram represents the band structure of an LED.

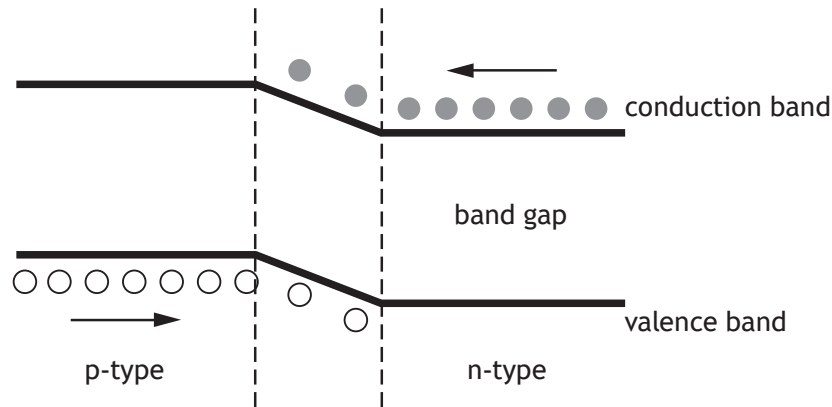

(i) A voltage is applied across an LED so that it is forward biased and emits light.

Using **band theory**, explain how the LED emits light.

3



12. (b) (continued)

MARKS

DO NOT
WRITE IN
THIS
MARGIN

- (ii) The energy gap between the valence band and conduction band is known as the band gap.

The band gap for the LED is 3.03×10^{-19} J

- (A) Calculate the wavelength of the light emitted by the LED.

4

Space for working and answer

- (B) Determine the colour of the light emitted by the LED.

1

[Turn over



* X 7 5 7 7 6 0 1 3 1 *

Question			Answer	Max Mark	Additional Guidance
12.	(a)	(i)	$V = IR$ (1) $V = 1 \cdot 80 (4 \cdot 8 + 0 \cdot 10)$ (1) $V = 8 \cdot 82 \text{ (V)}$ (1) Voltmeter reading ($= 12 \cdot 8 - 8 \cdot 82$) $= 4 \cdot 0 \text{ V}$ (1)	4	$lost\ volts = Ir$ $lost\ volts = 1 \cdot 80 \times 0 \cdot 10$ $lost\ volts = 0 \cdot 18 \text{ V}$ $V = IR$ $V = 1 \cdot 80 \times 4 \cdot 8$ $V = 8 \cdot 64 \text{ V}$ $V = 12 \cdot 8 - 0 \cdot 18 - 8 \cdot 64$ $V = 4 \cdot 0 \text{ V}$ OR $E = V + Ir$ $12 \cdot 8 = V + (1 \cdot 80 \times 0 \cdot 10)$ $V = 12 \cdot 62 \text{ V}$ $V = IR$ $V = 1 \cdot 80 \times 4 \cdot 8$ $V = 8 \cdot 64 \text{ V}$ $V = 12 \cdot 62 - 8 \cdot 64$ $V = 4 \cdot 0 \text{ V}$ 1 for all equations 1 for all substitutions 1 for all correct intermediate values 1 for final answer Sig figs: Accept 4, 3.98, 3.980
		(ii)	(Reading on voltmeter)/(voltage across lamp) decreases (1) (total) resistance decreases/ current increases. (1) lost volts increases/ V_{tpd} decreases/p.d. across $4 \cdot 8 \ \Omega$ increases/ <u>share</u> of p.d. across parallel branch decreases (1)	3	Look for this statement first - if incorrect then 0 marks. 'Reading on voltmeter decreases' on its own is worth 1 mark Any wrong physics in justification then maximum 1 mark for the statement Last 2 marks are independent of each other Can be justified by calculation (R_{lamp} is $2 \cdot 2 \ \Omega$, $I = 2 \cdot 1 \text{ A}$, gives $V = 2 \cdot 3 \text{ V}$)

Question			Answer	Max Mark	Additional Guidance
12.	(b)	(i)	<p>(Voltage applied causes) <u>electrons</u> to move towards <u>conduction band</u> of p-type/ away from n-type (towards the junction) (1)</p> <p>Electrons move/ drop from conduction band to valence band (1)</p> <p><u>Photon</u> emitted (when electron drops) (1)</p>	3	<p>Look for reference to either conduction or valence band first. Otherwise 0 marks.</p> <p>Bands must be named correctly in first two marking point eg not valency and not conductive</p> <p>Any answer using recombination of holes and electrons on its own, with no reference to band theory, is worth 0 marks.</p> <p>Must be directional</p> <p>Any wrong physics eg holes move up (from valence band to conduction band)- 0 marks</p> <p>This mark is dependent upon having at least one of the first two statements</p>
		(ii) (A)	$E = hf$ $3.03 \times 10^{-19} = 6.63 \times 10^{-34} \times f \quad (1)$ $f = 4.57 \times 10^{14} \text{ (Hz)}$ $v = f\lambda \quad (1) \text{ for both equations}$ $3 \times 10^8 = 4.57 \times 10^{14} \times \lambda \quad (1)$ $\lambda = 6.56 \times 10^{-7} \text{ m} \quad (1)$	4	<p>Alternative:</p> $E = \frac{hc}{\lambda} \quad (1)$ <p>Correct substitution (2) (1 for E and h; 1 for c)</p> <p>Final value of λ (1)</p> <p>Sig figs: Accept 6.6×10^{-7}, 6.564×10^{-7}, 6.5644×10^{-7}</p>
		(ii) (B)	Red (1)	1	<p>or consistent with (A)</p> <p>If wavelength stated in this part, then colour must be consistent with this value</p>

13. A technician sets up a circuit as shown.

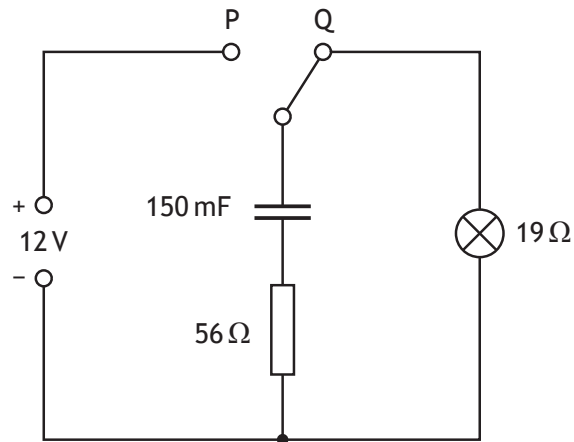

The power supply has negligible internal resistance.

(a) The capacitor is initially uncharged.

The switch is moved to position P and the capacitor charges.

(i) State the potential difference across the capacitor when it is fully charged. 1

(ii) Calculate the maximum energy stored by the capacitor. 3

Space for working and answer



* X 7 5 7 7 6 0 1 3 2 *

13. (continued)

MARKS

DO NOT
WRITE IN
THIS
MARGIN

- (b) The switch is now moved back to position Q.
Determine the maximum discharge current in the circuit.
Space for working and answer
- 3
- (c) The technician replaces the 150 mF capacitor with a capacitor of capacitance 47 mF.
The switch is moved to position P and the capacitor is fully charged.
The switch is now moved to position Q.
State the effect that this change has on the time the lamp stays lit.
You must justify your answer.
- 2

[Turn over for next question]



* X 7 5 7 7 6 0 1 3 3 *

Question			Answer	Max Mark	Additional Guidance
13.	(a)	(i)	12 V	1	Accept 12.0 V
		(ii)	$E = \frac{1}{2} C V^2$ (1) $E = \frac{1}{2} \times 150 \times 10^{-3} \times 12^2$ (1) $E = 11 \text{ J}$ (1)	3	Or consistent with a(i) Sig figs: 10 J 10.8 J 10.80 J $Q = CV$ and $E = \frac{1}{2} QV$ OR $Q = CV$ and $E = \frac{1}{2} \frac{Q^2}{C}$ (1) Both substitutions (1) Final answer (1)
	(b)		$(R_T = 56 + 19 = 75 \text{ } (\Omega))$ $I = \frac{V}{R}$ (1) $I = \frac{12}{75}$ (1) $I = 0.16 \text{ A}$ (1)	3	Or consistent with a(i) Candidates can arrive at this answer by alternative methods. Sig figs: 0.2 A 0.160 A 0.1600 A
	(c)		(Lamp stays lit for a) shorter time (1) (as smaller capacitance results in) less energy stored / less charge stored (1)	2	Look for this first Must provide relevant justification which is not wrong physics. If wrong physics - 0 marks. E is less because $E = \frac{1}{2} C V^2$ is acceptable. If candidate says the current stays the same, they must identify it is the <u>initial</u> current.

14. A student investigates the factors affecting the frequency of sound produced by a vibrating guitar string.

The guitar string is stretched over two supports and is made to vibrate as shown.

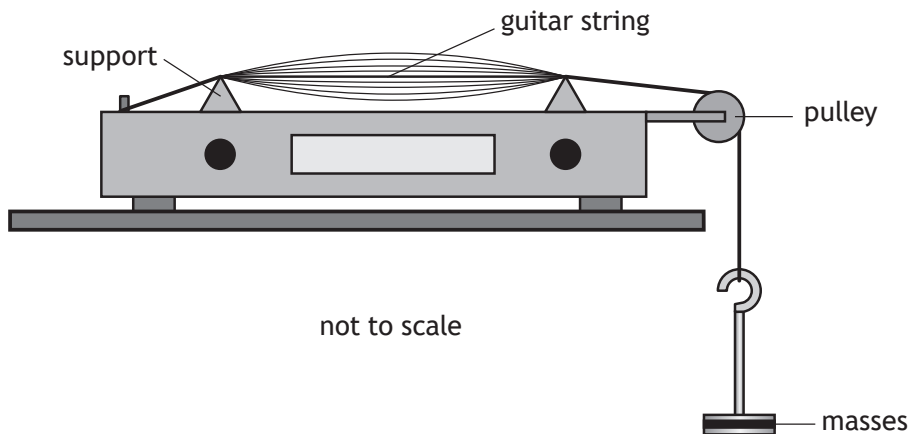

The frequency f of the sound produced by the vibrating string is given by the relationship

$$f = \frac{1}{2L} \sqrt{\frac{T}{\mu}}$$

where T is the tension in the string
 L is the distance between the supports
 μ is the mass per unit length of the string.

- (a) The tension in the string is 49.0 N and the mass per unit length of the string is $4.00 \times 10^{-4} \text{ kg m}^{-1}$.

The distance between the supports is 0.550 m.

Calculate the frequency f of the sound produced.

2

Space for working and answer



14. (continued)

- (b) The guitar string in part (a) is replaced by a different guitar string.

A student varies the tension T and measures the frequency f of the sound produced by the new guitar string.

The student records the following information.

T (N)	\sqrt{T} (N ^½)	f (Hz)
10	3.2	162
15	3.9	190
20	4.5	220
25	5.0	254
30	5.5	273

- (i) Using the square-ruled paper on *Page 36*, draw a graph of f against \sqrt{T} 3
- (ii) Use your graph to determine the frequency of the sound produced when the tension in the guitar string is 22 N. 1

[END OF QUESTION PAPER]



Question		Answer	Max Mark	Additional Guidance
14.	(a)	$f = \frac{1}{2L} \sqrt{\frac{T}{\mu}}$ $= \frac{1}{2 \times 0.550} \sqrt{\frac{49.0}{4.00 \times 10^{-4}}} \quad (1)$ $= 318 \text{ Hz} \quad (1)$	2	Substitution (1) Answer (1) Sig figs: Accept 320, 318.2, 318.18
	(b)	(i) <p>Suitable scales with labels on axes (quantity and units) (1)</p> <p>[Allow for axes starting at zero or broken axes or an appropriate value]</p> <p>Points plotted correctly (1)</p> <p>Best-fit straight line (1)</p>	3	If the origin is shown the scale must either be continuous or the axis must be 'broken'. Otherwise maximum 2 marks. If an invalid scale is used on either axis eg values from the table are used as the scale points - 0 marks Do not penalise if candidates plot \sqrt{T} against f Graphs of T and f are incorrect for (b)(i) - 0 marks, but can still gain marks for b(ii).
		(ii) 230 Hz	1	Must be consistent with the candidate's graph in (b)(i) ($\sqrt{22} = 4.7$ gives) 230 Hz Correct value of \sqrt{T} must be used If f against T is drawn in b(i), then this mark can still be accessed. If values from table are used as the scale points - 0 marks

[END OF MARKING INSTRUCTIONS]



National
Qualifications
2017

X757/76/02

**Physics
Section 1 — Questions**

WEDNESDAY, 17 MAY

9:00 AM – 11:30 AM

Instructions for the completion of Section 1 are given on *Page 02* of your question and answer booklet X757/76/01.

Record your answers on the answer grid on *Page 03* of your question and answer booklet.

Reference may be made to the Data Sheet on *Page 02* of this booklet and to the Relationships Sheet X757/76/11.

Before leaving the examination room you must give your question and answer booklet to the invigilator; if you do not, you may lose all the marks for this paper.



DATA SHEET

COMMON PHYSICAL QUANTITIES

Quantity	Symbol	Value	Quantity	Symbol	Value
Speed of light in vacuum	c	$3.00 \times 10^8 \text{ m s}^{-1}$	Planck's constant	h	$6.63 \times 10^{-34} \text{ J s}$
Magnitude of the charge on an electron	e	$1.60 \times 10^{-19} \text{ C}$	Mass of electron	m_e	$9.11 \times 10^{-31} \text{ kg}$
Universal Constant of Gravitation	G	$6.67 \times 10^{-11} \text{ m}^3 \text{ kg}^{-1} \text{ s}^{-2}$	Mass of neutron	m_n	$1.675 \times 10^{-27} \text{ kg}$
Gravitational acceleration on Earth	g	9.8 m s^{-2}	Mass of proton	m_p	$1.673 \times 10^{-27} \text{ kg}$
Hubble's constant	H_0	$2.3 \times 10^{-18} \text{ s}^{-1}$			

REFRACTIVE INDICES

The refractive indices refer to sodium light of wavelength 589 nm and to substances at a temperature of 273 K.

Substance	Refractive index	Substance	Refractive index
Diamond	2.42	Water	1.33
Crown glass	1.50	Air	1.00

SPECTRAL LINES

Element	Wavelength/nm	Colour	Element	Wavelength/nm	Colour
Hydrogen	656	Red	Cadmium	644	Red
	486	Blue-green		509	Green
	434	Blue-violet		480	Blue
	410	Violet	Lasers		
	397	Ultraviolet	<i>Element</i>	<i>Wavelength/nm</i>	<i>Colour</i>
	389	Ultraviolet	Carbon dioxide	9550 } 10590 }	Infrared
Sodium	589	Yellow	Helium-neon	633	Red

PROPERTIES OF SELECTED MATERIALS

Substance	Density/kg m ⁻³	Melting Point/K	Boiling Point/K
Aluminium	2.70×10^3	933	2623
Copper	8.96×10^3	1357	2853
Ice	9.20×10^2	273
Sea Water	1.02×10^3	264	377
Water	1.00×10^3	273	373
Air	1.29
Hydrogen	9.0×10^{-2}	14	20

The gas densities refer to a temperature of 273 K and a pressure of $1.01 \times 10^5 \text{ Pa}$.

SECTION 1 — 20 marks

Attempt ALL questions

1. The graph shows how the velocity of an object varies with time.

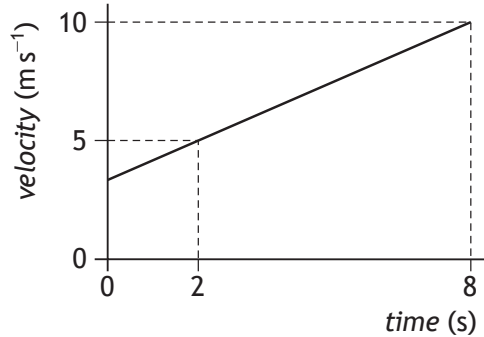

The acceleration of the object is

- A 0.83 m s^{-2}
 - B 1.2 m s^{-2}
 - C 2.5 m s^{-2}
 - D 5.0 m s^{-2}
 - E 6.0 m s^{-2} .
2. A block is resting on a horizontal surface.
A force of 24 N is now applied as shown and the block slides along the surface.

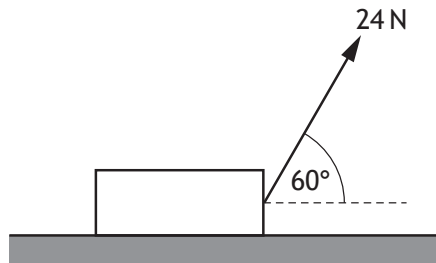

The mass of the block is 20 kg.

The acceleration of the block is 0.20 m s^{-2} .

The force of friction acting on the block is

- A 4.0 N
- B 8.0 N
- C 12 N
- D 16 N
- E 25 N.

3. The graph shows how the vertical speed of a skydiver varies with time.

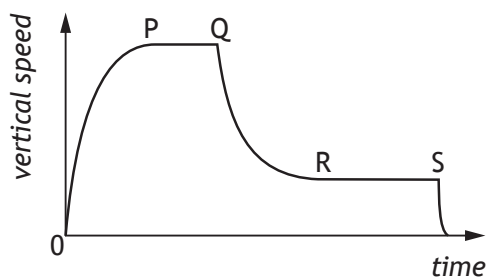

A student uses information from the graph to make the following statements.

- I The acceleration of the skydiver is greatest between P and Q.
- II The air resistance acting on the skydiver between Q and R is less than the weight of the skydiver.
- III The forces acting on the skydiver are balanced between R and S.

Which of these statements is/are correct?

- A I only
 - B II only
 - C III only
 - D I and II only
 - E I , II and III
4. A spacecraft is travelling at a constant speed of $2.75 \times 10^8 \text{ m s}^{-1}$ relative to a planet. A technician on the spacecraft measures the length of the spacecraft as 125 m. An observer on the planet measures the length of the spacecraft as
- A 36 m
 - B 50 m
 - C 124 m
 - D 314 m
 - E 433 m.

5. A galaxy has a recessional velocity of $0.30c$.
Hubble's Law predicts that the distance between Earth and this galaxy is
- A 1.3×10^{17} m
 - B 3.9×10^{25} m
 - C 1.3×10^{26} m
 - D 1.4×10^{41} m
 - E 4.5×10^{42} m.
6. Measurements of the expansion rate of the Universe lead to the conclusion that the rate of expansion is increasing.
Present theory proposes that this is due to
- A redshift
 - B dark matter
 - C dark energy
 - D the gravitational force
 - E cosmic microwave background radiation.
7. A student makes the following statements about the radiation emitted by stellar objects.
- I Stellar objects emit radiation over a wide range of frequencies.
 - II The peak wavelength of radiation is longer for hotter objects than for cooler objects.
 - III At all frequencies, hotter objects emit more radiation per unit surface area per unit time than cooler objects.
- Which of these statements is/are correct?
- A I only
 - B III only
 - C I and II only
 - D I and III only
 - E I, II and III

[Turn over

8. The following statement represents a nuclear reaction.

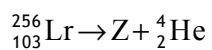

Nucleus Z is

- A ${}_{101}^{252}\text{Md}$
 - B ${}_{101}^{252}\text{No}$
 - C ${}_{101}^{256}\text{Md}$
 - D ${}_{105}^{260}\text{Db}$
 - E ${}_{103}^{252}\text{Lr}$.
9. Radiation is incident on a clean zinc plate causing photoelectrons to be emitted. The source of radiation is replaced with one emitting radiation of a higher frequency. The irradiance of the radiation incident on the plate remains unchanged. Which row in the table shows the effect of this change on the maximum kinetic energy of a photoelectron and the number of photoelectrons emitted per second?

	<i>Maximum kinetic energy of a photoelectron</i>	<i>Number of photoelectrons emitted per second</i>
A	no change	no change
B	no change	increases
C	increases	no change
D	increases	decreases
E	decreases	increases

10. Ultraviolet radiation of frequency 7.70×10^{14} Hz is incident on the surface of a metal. Photoelectrons are emitted from the surface of the metal.

The maximum kinetic energy of an emitted photoelectron is 2.67×10^{-19} J.

The work function of the metal is

- A 1.07×10^{-19} J
 - B 2.44×10^{-19} J
 - C 2.67×10^{-19} J
 - D 5.11×10^{-19} J
 - E 7.78×10^{-19} J.
11. A student makes the following statements about waves from coherent sources.
- I Waves from coherent sources have the same velocity.
 - II Waves from coherent sources have the same wavelength.
 - III Waves from coherent sources have a constant phase relationship.
- Which of these statements is/are correct?
- A I only
 - B II only
 - C I and II only
 - D I and III only
 - E I, II and III

[Turn over

12. A ray of red light passes from a liquid to a transparent solid.

The solid and the liquid have the same refractive index for this light.

Which row in the table shows what happens to the speed and wavelength of the light as it passes from the liquid into the solid?

	<i>Speed</i>	<i>Wavelength</i>
A	decreases	decreases
B	decreases	increases
C	no change	increases
D	increases	no change
E	no change	no change

13. A ray of blue light passes from air into a transparent block as shown.

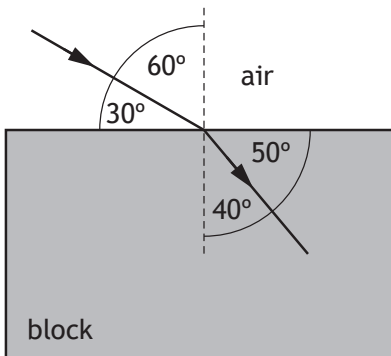

The speed of this light in the block is

- A $1.80 \times 10^8 \text{ m s}^{-1}$
- B $1.96 \times 10^8 \text{ m s}^{-1}$
- C $2.00 \times 10^8 \text{ m s}^{-1}$
- D $2.23 \times 10^8 \text{ m s}^{-1}$
- E $2.65 \times 10^8 \text{ m s}^{-1}$.

14. A student carries out an experiment to investigate how irradiance varies with distance.

A small lamp is placed at a distance d away from a light meter. The irradiance I at this distance is displayed on the meter. This measurement is repeated for a range of different distances.

The student uses these results to produce the graph shown.

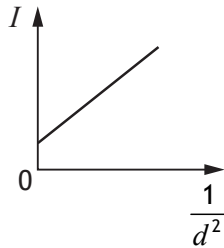

The graph indicates that there is a systematic uncertainty in this experiment.

Which of the following would be most likely to reduce the systematic uncertainty in this experiment?

- A Repeating the readings and calculating mean values.
 - B Replacing the small lamp with a larger lamp.
 - C Decreasing the brightness of the lamp.
 - D Repeating the experiment in a darkened room.
 - E Increasing the range of distances.
15. A point source of light is 8.00 m away from a surface. The irradiance, due to the point source, at the surface is 50.0 mW m^{-2} . The point source is now moved to a distance of 12.0 m from the surface.

The irradiance, due to the point source, at the surface is now

- A 22.2 mW m^{-2}
- B 26.0 mW m^{-2}
- C 33.3 mW m^{-2}
- D 75.0 mW m^{-2}
- E 267 mW m^{-2} .

[Turn over

16. The output from an a.c. power supply is connected to an oscilloscope. The trace seen on the oscilloscope screen is shown.

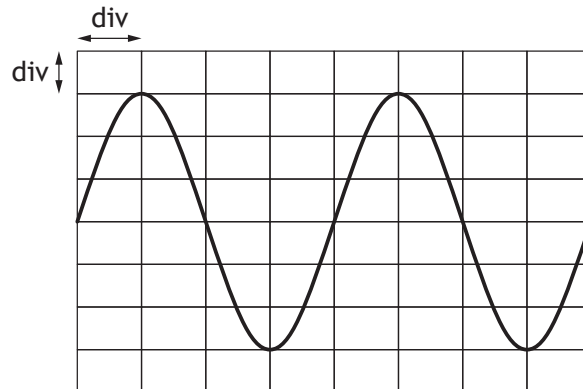

The Y-gain setting on the oscilloscope is 1.0V/div.

The r.m.s. voltage of the power supply is

- A 2.1 V
 - B 3.0 V
 - C 4.0 V
 - D 4.2 V
 - E 6.0 V.
17. A 20 μF capacitor is connected to a 12 V d.c. supply.

The maximum charge stored on the capacitor is

- A $1.4 \times 10^{-3} \text{ C}$
- B $2.4 \times 10^{-4} \text{ C}$
- C $1.4 \times 10^{-4} \text{ C}$
- D $1.7 \times 10^{-6} \text{ C}$
- E $6.0 \times 10^{-7} \text{ C}$.

18. A circuit containing a capacitor is set up as shown.

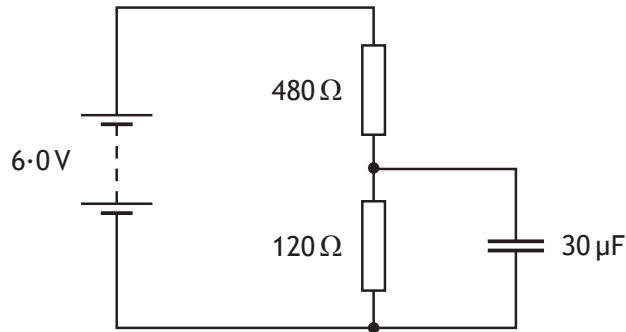

The supply has negligible internal resistance.

The maximum energy stored in the capacitor is

- A $5.4 \times 10^{-4} \text{ J}$
 - B $3.5 \times 10^{-4} \text{ J}$
 - C $1.4 \times 10^{-4} \text{ J}$
 - D $3.4 \times 10^{-5} \text{ J}$
 - E $2.2 \times 10^{-5} \text{ J}$.
19. A student makes the following statements about conductors, insulators and semiconductors.

- I In conductors, the conduction band is completely filled with electrons.
- II In insulators, the gap between the valence band and the conduction band is large.
- III In semiconductors, increasing the temperature increases the conductivity.

Which of these statements is/are correct?

- A I only
- B II only
- C III only
- D I and II only
- E II and III only

[Turn over for next question

20. Astronomers use the following relationship to determine the distance, d , to a star.

$$F = \frac{L}{4\pi d^2}$$

For a particular star the following measurements are recorded:

apparent brightness, $F = 4.4 \times 10^{-10} \text{ W m}^{-2}$

luminosity, $L = 6.1 \times 10^{30} \text{ W}$

Based on this information, the distance to this star is

- A $3.3 \times 10^{19} \text{ m}$
- B $1.5 \times 10^{21} \text{ m}$
- C $3.7 \times 10^{36} \text{ m}$
- D $1.1 \times 10^{39} \text{ m}$
- E $3.9 \times 10^{39} \text{ m}$.

[END OF SECTION 1. NOW ATTEMPT THE QUESTIONS IN SECTION 2 OF YOUR QUESTION AND ANSWER BOOKLET]

Marking instructions for each question**Section 1**

Question	Answer	Max mark
1.	A	1
2.	B	1
3.	C	1
4.	B	1
5.	B	1
6.	C	1
7.	D	1
8.	A	1
9.	D	1
10.	B	1
11.	E	1
12.	E	1
13.	D	1
14.	D	1
15.	A	1
16.	A	1
17.	B	1
18.	E	1
19.	E	1
20.	A	1

FOR OFFICIAL USE



--	--	--	--	--	--

National
Qualifications
2017

Mark

--

X757/76/01

**Physics
Section 1 — Answer Grid
and Section 2**

WEDNESDAY, 17 MAY

9:00 AM – 11:30 AM



* X 7 5 7 7 6 0 1 *

Fill in these boxes and read what is printed below.

Full name of centre

--

Town

--

Forename(s)

--

Surname

--

Number of seat

--

Date of birth

Day

Month

Year

Scottish candidate number

--	--

--	--

--	--

--	--	--	--	--	--	--	--	--	--

Total marks — 130

SECTION 1 — 20 marks

Attempt ALL questions.

Instructions for the completion of Section 1 are given on *Page 02*.

SECTION 2 — 110 marks

Attempt ALL questions.

Reference may be made to the Data Sheet on *Page 02* of the question paper X757/76/02 and to the Relationship Sheet X757/76/11.

Care should be taken to give an appropriate number of significant figures in the final answers to calculations.

Write your answers clearly in the spaces provided in this booklet. Additional space for answers and rough work is provided at the end of this booklet. If you use this space you must clearly identify the question number you are attempting. Any rough work must be written in this booklet. You should score through your rough work when you have written your final copy.

Use **blue** or **black** ink.

Before leaving the examination room you must give this booklet to the Invigilator; if you do not, you may lose all the marks for this paper.



* X 7 5 7 7 6 0 1 0 1 *

SECTION 2 — 110 marks
Attempt ALL questions

1. A student is on a stationary train.
The train now accelerates along a straight level track.
The student uses an app on a phone to measure the acceleration of the train.



- (a) The train accelerates uniformly at 0.32 m s^{-2} for 25 seconds.
- (i) State what is meant by *an acceleration of 0.32 m s^{-2}* . 1
- (ii) Calculate the distance travelled by the train in the 25 seconds. 3
Space for working and answer



1. (continued)

MARKS	DO NOT WRITE IN THIS MARGIN

- (b) Later in the journey, the train is travelling at a constant speed as it approaches a bridge.

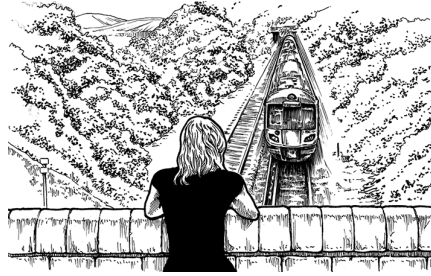

A horn on the train emits sound of frequency 270 Hz.

The frequency of the sound heard by a person standing on the bridge is 290 Hz.

The speed of sound in air is 340 m s^{-1} .

- (i) Calculate the speed of the train.

3

Space for working and answer

- (ii) The train continues to sound its horn as it passes under the bridge.

Explain why the frequency of the sound heard by the person standing on the bridge decreases as the train passes under the bridge and then moves away.

You may wish to use a diagram.

1



Section 2

Question			Answer	Max mark	Additional guidance
1.	(a)	(i)	The velocity increases by 0.32 m s^{-1} each/per second	1	Accept: Speed increases by ... Rate of change of velocity/speed is ... Train gets faster by ... Velocity/speed changes by ...
		(ii)	$s = ut + \frac{1}{2}at^2 \quad (1)$ $s = ((0 \times 25)) + (0.5 \times 0.32 \times 25^2) \quad (1)$ $s = 100 \text{ m} \quad (1)$	3	Accept: $v = u + at$ $v = (0) + 0.32 \times 25$ $v = 8(\text{ms}^{-1})$ $v^2 = u^2 + 2as$ $8^2 = (0^2) + (2 \times 0.32 \times s)$ $s = 100 \text{ m}$ OR $s = \frac{1}{2}(u + v)t$ or $s = \bar{v} t$ $s = \frac{1}{2}((0) + 8) \times 25$ $s = 100 \text{ m}$ Note: 1 mark for ALL equations 1 mark for ALL substitutions 1 mark for correct answer
	(b)	(i)	$f_o = f_s \left(\frac{v}{v \pm v_s} \right) \quad (1)$ $290 = 270 \left(\frac{340}{340 - v_s} \right) \quad (1)$ $v_s = 23 \text{ms}^{-1} \quad (1)$	3	$f_o = f_s \left(\frac{v}{v - v_s} \right)$ is also acceptable Accept 20, 23.4, 23.45
		(ii)	Statement that there are fewer wavefronts per second. OR The wavefronts are further apart OR The wavelength increases OR diagram showing wavefronts closer together ahead of the train and further apart behind it. or any similar response	1	In a diagram, there must be an implication of direction of travel. Do Not Accept Any answer that implies that the frequency/wavelength of the horn itself is changing.

2. A white snooker ball and a black snooker ball travel towards each other in a straight line.

The white ball and the black ball each have a mass of 0.180 kg .

Just before the balls collide head-on, the white ball is travelling at 2.60 m s^{-1} to the right and the black ball is travelling at 1.80 m s^{-1} to the left.

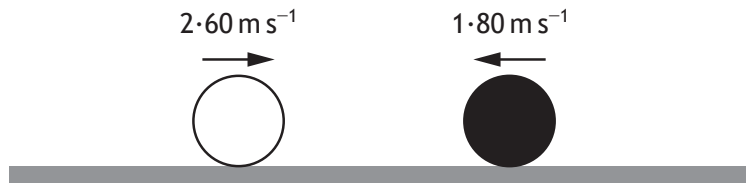

After the collision, the black ball rebounds with a velocity of 2.38 m s^{-1} to the right.

- (a) (i) Determine the velocity of the white ball immediately after the collision.

3

Space for working and answer

- (ii) The collision between the balls is inelastic.

State what is meant by an *inelastic collision*.

1



* X 7 5 7 7 6 0 1 0 8 *

2. (continued)

MARKS
DO NOT
WRITE IN
THIS
MARGIN

- (b) A student carries out an experiment to measure the average force exerted by a cue on a ball.

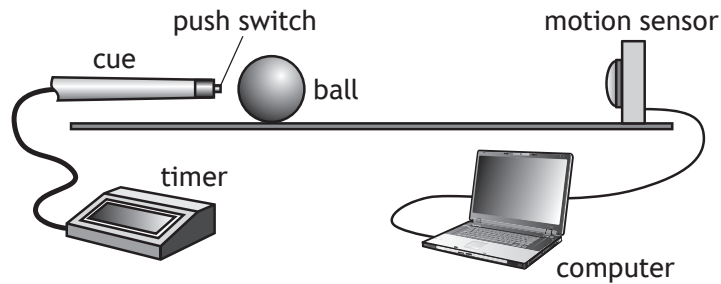

The cue hits the stationary ball.

The timer records the time the cue is in contact with the ball.

The computer displays the speed of the ball.

The results are shown.

Time of contact between the cue and the ball = (0.040 ± 0.001) s

Speed of the ball immediately after contact = (0.84 ± 0.01) m s⁻¹

Mass of the ball = (0.180 ± 0.001) kg

- (i) Calculate the average force exerted on the ball by the cue.
An uncertainty in this value is not required.

3

Space for working and answer

- (ii) Determine the percentage uncertainty in the value for the average force on the ball.

2

Space for working and answer



* X 7 5 7 7 6 0 1 0 9 *

Question			Answer	Max mark	Additional guidance
2.	(a)	(i)	<p>(total momentum before = total momentum after)</p> $m_x u_x + m_y u_y = m_x v_x + m_y v_y \quad (1)$ $(0.180 \times 2.60) + (0.180 \times -1.80)$ $= (0.180 v_x + 0.180 \times 2.38) \quad (1)$ $0.468 - 0.324 = 0.180 v_x + 0.4284$ $v_x = -1.58 \text{ m s}^{-1} \quad (1)$ <p>(Accept '1.58 ms⁻¹ to the left' or an indication of direction eg arrow left)</p>	3	<p>1 mark for equating the momentums before and after. 1 mark for the substitutions. 1 mark for answer including unit.</p> <p>Signs must be consistent.</p> <p>Allow cancellation of masses throughout the relationship.</p> <p>Accept $v_x = -1.58 \text{ ms}^{-1}$ to the left as "loose" use of direction.</p> <p>Sig fig 1.6, 1.580, 1.5800</p>
		(ii)	<p>kinetic energy is lost/greater before the collision than after.</p>	1	<p>Do not accept: E_k before $\neq E_k$ after. E_k is not conserved.</p>
	(b)	(i)	$Ft = mv - mu \quad (1)$ $F \times 0.040 = (0.180 \times 0.84) - (0.180 \times 0) \quad (1)$ $F = 3.8 \text{ N} \quad (1)$	3	<p>Accept:</p> $a = \frac{v-u}{t}$ $a = \frac{0.84(-0)}{0.040}$ $a = 21 \text{ (m s}^{-2}\text{)}$ $F = ma$ $F = 0.180 \times 21$ $F = 3.8 \text{ N}$ <p>Sig figs 4, 3.78, 3.780</p> <p>Note: 1 mark for ALL equations 1 mark for ALL substitutions 1 mark for correct answer</p> <p>Ignore any uncertainty calculations within this question.</p>
		(ii)	$\left(\frac{0.01}{0.84} \times 100 = 1.2 \right)$ $\left(\frac{0.001}{0.180} \times 100 = 0.56 \right)$ $\frac{0.001}{0.040} \times 100 (=2.5) \quad (1)$ <p>(Uncertainty in F is) 2.5% (1)</p>	2	<p>1 mark for correct or implied working for % uncertainty in t.</p> <p>1 mark for indicating 2.5% as the largest.</p> <p>Must have % in final answer - equivalent to 'unit'.</p> <p>Accept: 3%</p>

3. A ball is thrown vertically upwards.
The ball is above the ground when released.

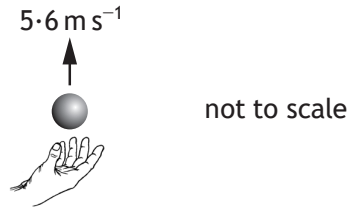

————— ground

The graph shows how the vertical velocity of the ball varies with time from the instant it is released until just before it hits the ground.

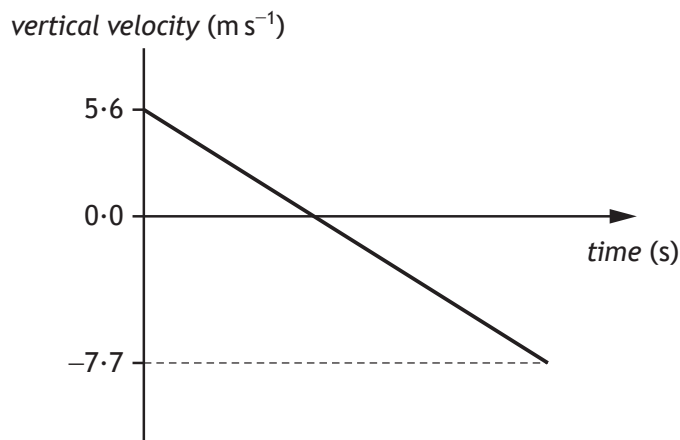

The effects of air resistance can be ignored.

- (a) (i) Calculate the time taken for the ball to reach its maximum height. 3
Space for working and answer



3. (a) (continued)

- (ii) Calculate the distance the ball falls from its maximum height to the ground.

3

Space for working and answer

- (b) The ball is now thrown vertically upwards from the same height with a greater initial vertical velocity.

Add a line to the graph below to show how the vertical velocity of the ball varies with time from the instant it is released until just before it hits the ground.

The effects of air resistance can be ignored.

Additional numerical values on the axes are not required.

3

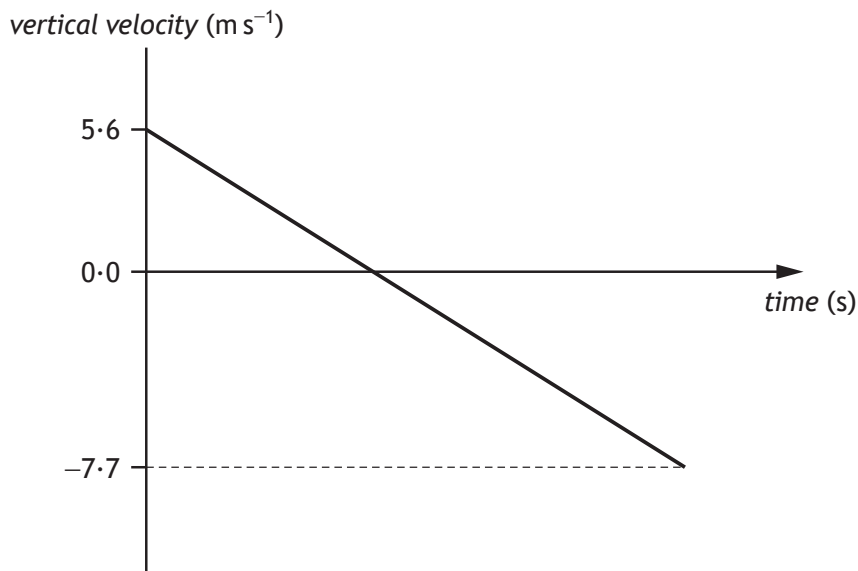

(An additional graph, if required, can be found on *Page 39*.)



Question			Answer	Max mark	Additional guidance
3.	(a)	(i)	$v = u + at$ $0 = 5.6 + (-9.8)t$ $t = 0.57 \text{ s}$	<p>1</p> <p>1</p> <p>1</p>	<p>3</p> <p>u and a must have opposite signs</p> <p>Accept $0 = 5.6 - 9.8t$</p> <p>Accept 0.6, 0.571, 0.5714</p> <p>Alternative method: $v^2 = u^2 + 2as$ $0^2 = 5.6^2 + 2 \times (-9.8) \times s$ $s = 1.6 \text{ (m)}$ $s = \frac{1}{2}(u + v)t$ $1.6 = \left(\frac{5.6 + 0}{2}\right)t$ $t = 0.57 \text{ s}$</p> <p>If an alternative method is used, 1 mark for ALL equations 1 mark for ALL substitutions 1 mark for correct answer</p> <p>If candidate answers question in terms of an object falling from the max height and reaching a velocity of 5.6ms^{-1}, then a suitable justification MUST be given to allow access to 2nd and 3rd marks.</p> <p>A negative value for time is wrong physics - max 1 mark.</p>

Question			Answer	Max mark	Additional guidance
3.	(a)	(ii)	$v^2 = u^2 + 2as$ $(-7.7)^2 = 0^2 + 2 \times (-9.8)s$ $s = -3.0 \text{ m}$ (Distance = 3.0 m)	1 1 1	3 v and a must have the same sign and calculated value of s must agree with sign convention used. Accept 3, 3.03, 3.025 Alternative method: $mgh = \frac{1}{2}mv^2$ $gh = \frac{1}{2}v^2$ $9.8 \times h = \frac{1}{2} \times 7.7^2$ $h = 3.0 \text{ m}$ If an alternative method is used, 1 mark for ALL equations 1 mark for ALL substitutions 1 mark for correct answer
		(b)	Starting point greater than 5.6 Final point beyond -7.7 Acceptably parallel line	1 1 1	3 Independent marks Must be <u>one</u> continuous acceptably <u>straight</u> line for third mark.

4. Some motorways have variable speed limits, with overhead information boards displaying the maximum speed allowed. This system is designed to keep the traffic flowing and to avoid congestion.



In this system, the flow of traffic is observed and the maximum speed to be displayed is determined using

$$\text{speed} = \text{frequency} \times \text{wavelength}$$

Use your knowledge of physics to comment on this system for determining the maximum speed to be displayed.

3



5. Planets outside our solar system are called exoplanets.

An exoplanet of mass 5.69×10^{27} kg orbits a star of mass 3.83×10^{30} kg.

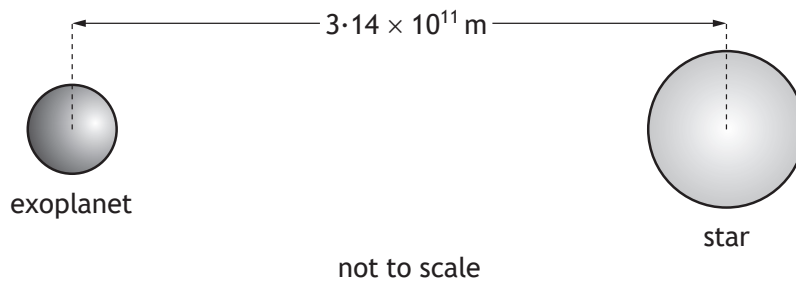

(a) (i) Compare the mass of the star with the mass of the exoplanet in terms of orders of magnitude.

2

Space for working and answer

(ii) The distance between the exoplanet and the star is 3.14×10^{11} m.
Calculate the gravitational force between the star and the exoplanet.

3

Space for working and answer



5. (continued)

- (b) The gravitational force between the star and the exoplanet causes the star to follow a circular path as the exoplanet orbits the star. Small differences in the wavelength of the light from the star are observed on Earth.

Light from the star is redshifted when the star moves away from the Earth and blueshifted when the star moves towards the Earth.

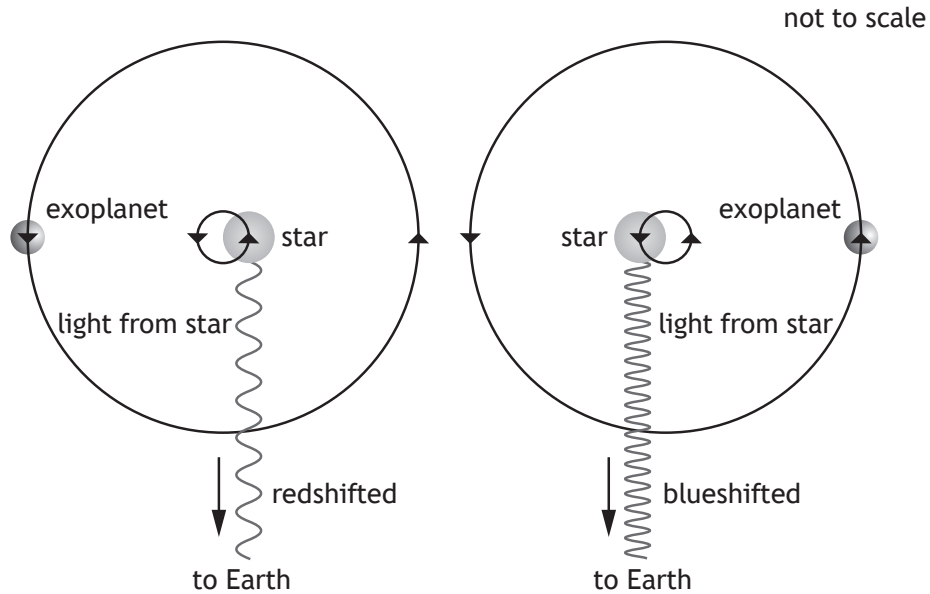

- (i) Calculate the redshift of light from the star observed on Earth when the star is moving away from the Earth at $6.60 \times 10^3 \text{ m s}^{-1}$.

3

Space for working and answer

- (ii) For an exoplanet of greater mass at the same distance from the star, suggest whether the radius of the circular path followed by the star would be greater than, less than, or the same as that for an exoplanet of smaller mass.

1



Question			Answer	Max mark	Additional guidance
5.	(a)	(i)	$\left(\frac{3.83 \times 10^{30}}{5.69 \times 10^{27}}\right) = 673$ <p>1</p> <p>(Star is) 3 (orders of magnitude) <u>greater</u></p> <p>1</p> <p>OR <u>Exoplanet</u> is 3 (orders of magnitude) <u>smaller</u></p>	2	<p>Sig figs: accept 670, 673.1, 673.11</p> <p>Or $\left(\frac{10^{30}}{10^{27}}\right) = 1000$ or 10^3</p> <p>Or (30-27) = 3</p> <p>1</p> <p>'3 greater' on its own is worth 2 marks.</p> <p>Care should be taken where candidates answer by the reciprocal method - 2 marks are still available.</p> <p>$\left(\frac{5.69 \times 10^{27}}{3.83 \times 10^{30}}\right) = 1.49 \times 10^{-3}$</p> <p>1</p> <p>Comparison statement</p> <p>1</p> <p>'Greater' on its own - 0 marks</p>
		(ii)	$F = G \frac{m_1 m_2}{r^2}$ <p>1</p> $F = 6.67 \times 10^{-11} \frac{5.69 \times 10^{27} \times 3.83 \times 10^{30}}{(3.14 \times 10^{11})^2}$ <p>1</p> $F = 1.47 \times 10^{25} \text{ N}$ <p>1</p>	3	<p>Sig figs: Accept 1.5, 1.474, 1.4743</p>
	(b)	(i)	$z = \frac{v}{c}$ <p>1</p> $z = \frac{6.60 \times 10^3}{3.00 \times 10^8}$ <p>1</p> $z = 2.20 \times 10^{-5}$ <p>1</p>	3	<p>Sig figs: Accept 2.2, 2.200, 2.2000</p>
		(ii)	Greater (than)	1	<p>Accept any word synonymous with 'greater'.</p> <p>Any correct suggestion followed by wrong physics 0 marks.</p>

6. The visible spectrum of light emitted by a star is observed to contain a number of dark lines. The dark lines occur because certain wavelengths of light are absorbed when light passes through atoms in the star's outer atmosphere.

The diagram shows some of the energy levels for a hydrogen atom.

$$E_3 \text{ ————— } -1.36 \times 10^{-19} \text{ J}$$

$$E_2 \text{ ————— } -2.42 \times 10^{-19} \text{ J}$$

$$E_1 \text{ ————— } -5.42 \times 10^{-19} \text{ J}$$

$$E_0 \text{ ————— } -21.8 \times 10^{-19} \text{ J}$$

- (a) For the energy levels shown in the diagram, identify the electron transition that would lead to the absorption of a photon with the highest frequency.

1

- (b) An electron makes the transition from energy level E_1 to E_3 . Determine the frequency of the photon absorbed.

3

Space for working and answer



* X 7 5 7 7 6 0 1 1 6 *

Question		Answer	Max mark	Additional guidance
6.	(a)	E_0 to E_3 $E_0 \rightarrow E_3$ Between E_0 and E_3	1	Could be shown by an arrow on the diagram showing the correct upwards transition. Direction must be correct. Do not accept: $E_0 - E_3$ Between E_3 and E_0
	(b)	$E_2 - E_1 = hf$ 1 $-1.36 \times 10^{-19} - (-5.42 \times 10^{-19})$ 1 $= 6.63 \times 10^{-34} \times f$ $f = 6.12 \times 10^{14} \text{ Hz}$ 1	3	Sig figs: Accept 6.1 , 6.124, 6.1237 Accept: $(\Delta)E = hf$ or $E_3 - E_1 = hf$ for formula mark $5.42 \times 10^{-19} - 1.36 \times 10^{-19}$ $= 6.63 \times 10^{-34} \times f$ for substitution mark Note: Correct $\Delta E = 4.06 \times 10^{-19} (J)$ $1.36 \times 10^{-19} - 5.42 \times 10^{-19}$ for ΔE , maximum 1 mark for a correct formula.

7. The following diagram gives information on the Standard Model of fundamental particles.

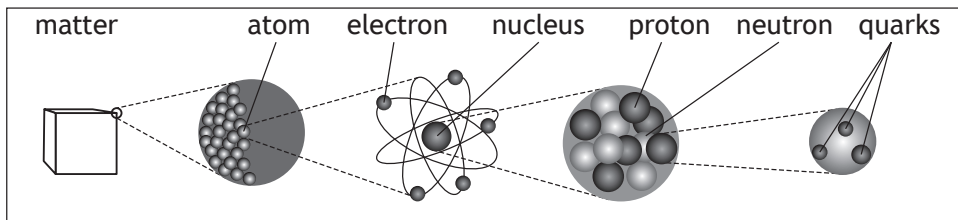

- (a) Explain why the proton and the neutron are **not** fundamental particles. 1

- (b) An extract from a data book contains the following information about three types of sigma (Σ) particles. Sigma particles are made up of three quarks.

Particle	Symbol	Quark Content	Charge	Mean lifetime (s)
sigma plus	Σ^+	up up strange	$+1e$	8.0×10^{-11}
neutral sigma	Σ^0	up down strange	0	7.4×10^{-20}
sigma minus	Σ^-	down down strange	$-1e$	1.5×10^{-10}

- (i) A student makes the following statement.

All baryons are hadrons, but not all hadrons are baryons.

Explain why this statement is correct. 2

- (ii) The charge on an up quark is $+\frac{2}{3}e$.

Determine the charge on a strange quark. 1

Space for working and answer



7. (continued)

(c) (i) State the name of the force that holds the quarks together in the sigma (Σ) particle.

1

(ii) State the name of the boson associated with this force.

1

(d) Sigma minus (Σ^-) particles have a mean lifetime of 1.5×10^{-10} s in their frame of reference.

Σ^- are produced in a particle accelerator and travel at a speed of $0.9c$ relative to a stationary observer.

Calculate the mean lifetime of the Σ^- particle as measured by this observer.

3

Space for working and answer



* X 7 5 7 7 6 0 1 1 9 *

Question		Answer	Max mark	Additional guidance
7.	(a)	They are composed of other particles/quarks, (fundamental particles are not).	1	Accept they are composite particles.
	(b)	(i) Baryons are (hadrons as they are) composed of (three) <u>quarks</u> . 1 Mesons/some hadrons are made from a quark - anti-quark pair so are not baryons. 1	2	For first mark, a correct statement that baryons consist of quarks. For second mark, a correct statement that there are other hadrons that have a different quark-count from baryons. Accept two quarks in place of quark-anti-quark pair.
		(ii) $-1/3(e)$	1	
	(c)	(i) strong (nuclear force)	1	
		(ii) gluon	1	<u>Or</u> consistent with (c)(i). A carry forward mark is only accessible if one of the four fundamental forces is identified in (c)(i).
	(d)	$t' = \frac{t}{\sqrt{1 - \left(\frac{v}{c}\right)^2}}$ 1 $t' = \frac{1.5 \times 10^{-10}}{\sqrt{1 - \frac{(0.9c)^2}{c^2}}}$ 1 $t' = 3.4 \times 10^{-10} \text{ s}$ 1	3	Accept: 3, 3.44, 3.441 Accept: $\frac{1.5 \times 10^{-10}}{\sqrt{1 - 0.9^2}}$

8. X-ray machines are used in hospitals.

An X-ray machine contains a linear accelerator that is used to accelerate electrons towards a metal target.

The linear accelerator consists of hollow metal tubes placed in a vacuum.

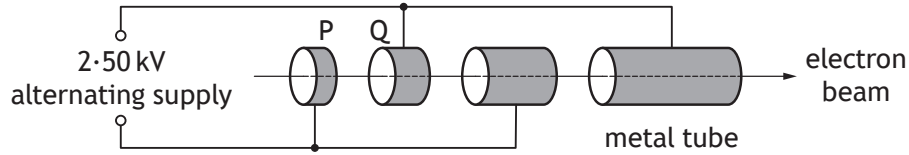

Electrons are accelerated across the gaps between the tubes by an alternating supply.

(a) (i) Calculate the work done on an electron as it accelerates from P to Q. 3
Space for working and answer

(ii) Explain why an alternating supply is used in the linear accelerator. 1



8. (continued)

- (b) The electron beam is then passed into a “slalom magnet” beam guide. The function of the beam guide is to direct the electrons towards a metal target.

Inside the beam guides R and S, two different magnetic fields act on the electrons.

Electrons strike the metal target to produce high energy photons of radiation.

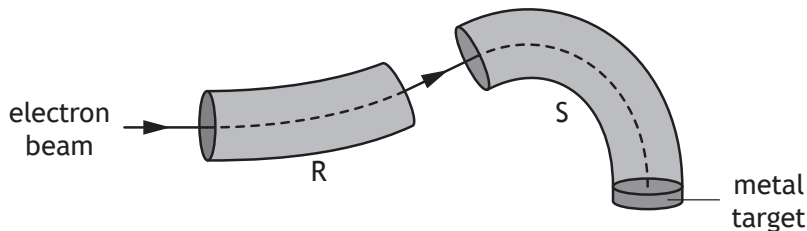

- (i) Determine the direction of the magnetic field inside beam guide R. 1
- (ii) State **two** differences between the magnetic fields inside beam guides R and S. 2
- (c) Calculate the minimum speed of an electron that will produce a photon of energy 4.16×10^{-17} J. 3

Space for working and answer



Question			Answer	Max mark	Additional guidance
8.	(a)	(i)	$W \text{ or } E_w = QV$ $= 1.60 \times 10^{-19} \times 2.50 \times 10^3$ $= 4.00 \times 10^{-16} \text{ J}$	1 1 1	3 Suspend significant figure rule and accept $4 \times 10^{-16} \text{ J}$. Ignore negative sign for charge.
		(ii)	Particle (always) accelerates in the same direction/forwards OR Force on particle/electron is always in same direction OR Ensure the direction of the electric field is correct when particle/ electron passes between (alternate) gaps	1	
	(b)	(i)	Out of page	1	Do not accept: 'upwards' on its own, OR 'out of the page' with other comments such as 'circular' 'clockwise'.
		(ii)	(Magnetic fields are in) <u>opposite</u> directions 1 (Magnetic field in) S is <u>stronger</u> than (field in) R 1	2	Independent marks Or consistent with (b)(i) for first mark as long as a <u>linear</u> field is described. Accept statement referring to direction of (magnetic field in) S alone ONLY if (b)(i) has been answered. Do not accept: 'different directions' 'force in S is opposite to force in R' alone.
	(c)		$E_k = \frac{1}{2}mv^2$ $4.16 \times 10^{-17} = \frac{1}{2} \times 9.11 \times 10^{-31} \times v^2$ 1 $v = 9.56 \times 10^6 \text{ ms}^{-1}$	1 1	3 Accept: 9.6, 9.557, 9.5566

9. A diagram from a 'How Things Work' website contains information about a nuclear fusion reaction.

Reaction of helium-3 with deuterium

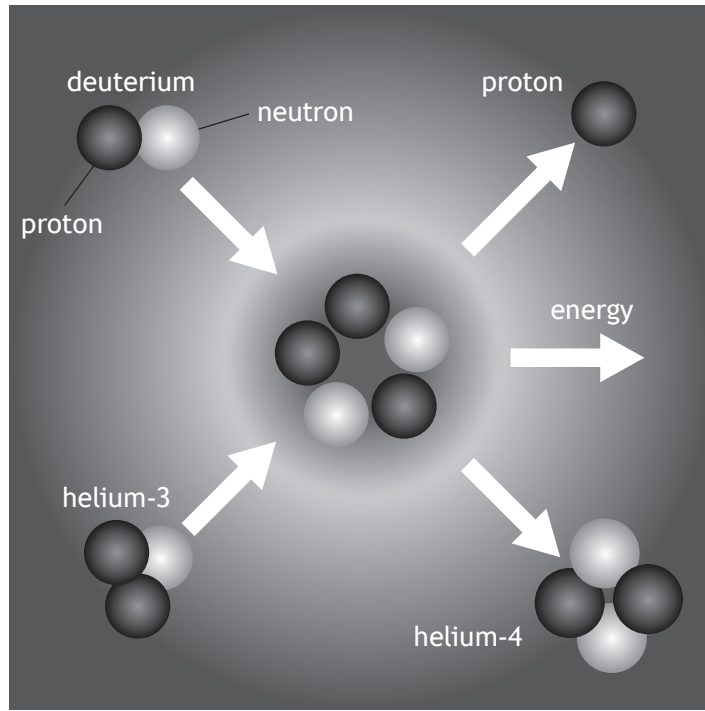

- (a) State what is meant by the term *nuclear fusion*.

1



9. (continued)

(b) The following statement represents this fusion reaction.

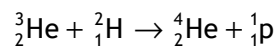

The mass of the particles involved in the reaction are shown in the table.

Particle	Mass (kg)
${}^3_2\text{He}$	5.008×10^{-27}
${}^2_1\text{H}$	3.344×10^{-27}
${}^4_2\text{He}$	6.646×10^{-27}
${}^1_1\text{p}$	1.673×10^{-27}

(i) Explain why energy is released in this reaction.

1

(ii) Determine the energy released in this reaction.

4

Space for working and answer

* X 7 5 7 7 6 0 1 2 3 *

Question			Answer	Max mark	Additional guidance
9.	(a)		(Two) small nuclei combine to form a larger nucleus	1	<p>Accept: 'light' and 'heavy'. Accept: 'fuse', 'join'</p> <p>Do not accept: Atoms/molecules/particles/ isotopes/elements.</p> <p>Do not accept: 'react' in place of 'combine' or equivalent of 'combining'.</p>
	(b)	(i)	(Some) mass (is lost and) <u>converted</u> to energy	1	<p>There must be an indication of mass being converted (or an equivalent term) to energy e.g. transformed, becomes, changed to etc...</p> <p>Do not accept: transferred...</p> <p>Mass is lost on its own - 0 marks. Mass defect is wrong physics - 0 marks.</p>

10. An experiment is carried out to determine the wavelength of light from a laser.

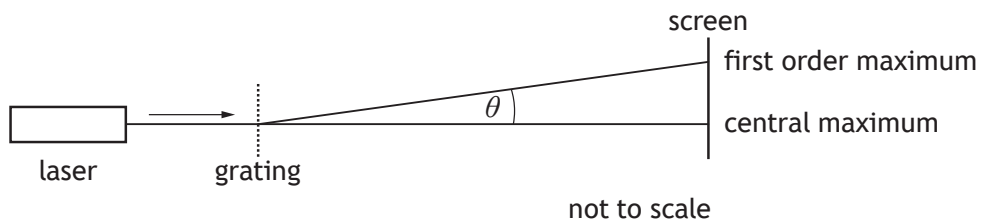

- (a) Explain, in terms of waves, how a maximum is formed.

1

- (b) The experiment is carried out with four gratings.

The separation of the slits d is different for each grating.

The angle between the central maximum and the first order maximum θ , produced by each grating, is measured.

The results are used to produce a graph of $\sin\theta$ against $\frac{1}{d}$.

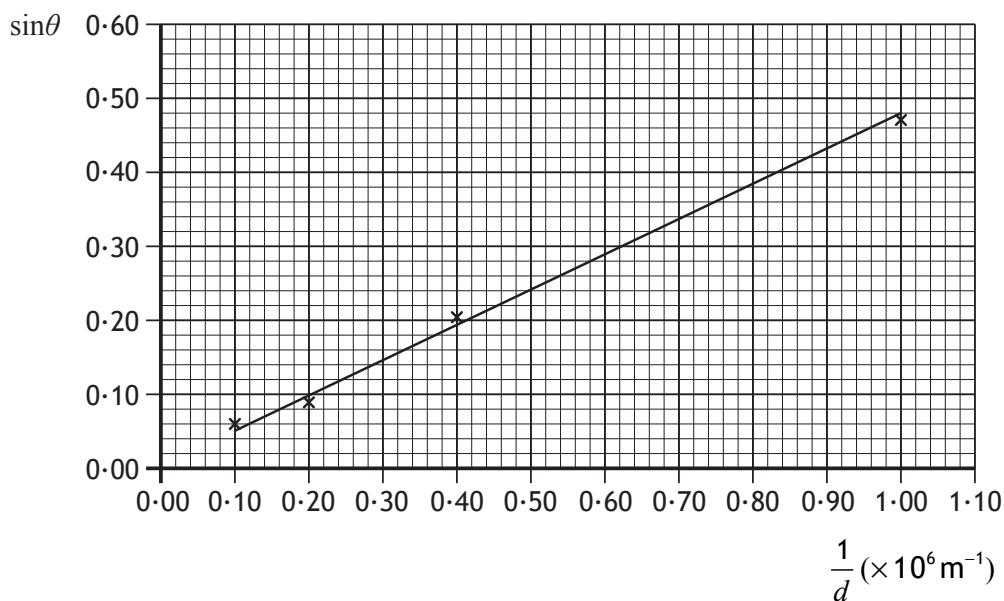

10. (b) (continued)

- (i) Determine the wavelength of the light from the laser used in this experiment.

3

Space for working and answer

- (ii) Determine the angle θ produced when a grating with a spacing d of 2.0×10^{-6} m is used with this laser.

3

Space for working and answer

- (c) Suggest **two** improvements that could be made to the experiment to improve reliability.

2

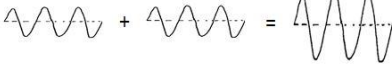

* X 7 5 7 7 6 0 1 2 5 *

Question		Answer	Max mark	Additional guidance
10.	(a)	Waves <u>meet</u> in phase OR Crest <u>meets</u> crest OR Trough <u>meets</u> trough OR Path difference = $m\lambda$	1	Accept 'peak' for 'crest'. Can be shown by diagram:  Do not accept 'join' or 'merge' alone.
	(b)	(i) statement that $\lambda = \text{gradient}$ or link λ to the gradient subs to calculate gradient $\lambda = 4.8 \times 10^{-7}\text{m}$	1 1 1	3 Acceptable range using the 'gradient' method, 4.7 to $5.0 \times 10^{-7}\text{m}$, but intermediate steps still need to be checked. If any of the plotted points on the graph ('x') are used, then maximum 1 for formula. $m\lambda = d \sin \theta$ 1 Accept : $\lambda = d \sin \theta$ in this case Subs of values from line 1 $\lambda = 4.8 \times 10^{-7}\text{m}$ 1
		(ii) ($d = 2 \times 10^{-6}$ gives:) $\frac{1}{d} = 0.50 \times 10^6$ $\sin \theta = 0.24$ from graph $\theta = 14^\circ$	1 1 1	3 Sig figs: Accept 10, 13.9, 13.89 Alternative method - $m\lambda = d \sin \theta$ 1 Accept: $\lambda = d \sin \theta$ in this case $1 \times 4.8 \times 10^{-7} = 2.0 \times 10^{-6} \times \sin \theta$ 1 $\theta = 14^\circ$ 1 Or consistent with (b)(i).
	(c)	Any two correct answers from: Repeat measurements Use additional gratings Move screen further away Use second order maxima to determine θ Measure angle from first order to first order	2	Independent marks For the first point opposite, it must be clear that the candidate is implying that the measurements are being repeated. Do not accept: 'repeat the experiment' 'different sizes of slits/gratings' 'darkened room' Any <u>additional</u> improvements stated (beyond two) that <u>reduce reliability</u> , then \pm rule applies.

11. The use of analogies from everyday life can help better understanding of physics concepts. A car moving from a smooth surface to a rough surface, eg from a road to sand, can be used as an analogy for the refraction of light.

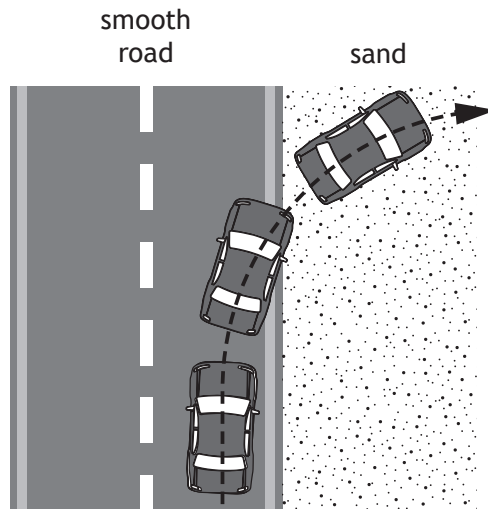

Use your knowledge of physics to comment on this analogy.

3



12. A lamp is connected to a battery containing two cells as shown.

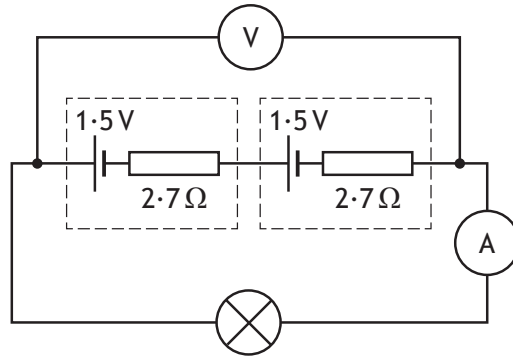

The e.m.f. of each cell is 1.5 V and the internal resistance of each cell is 2.7 Ω.
The reading on the ammeter is 64 mA.

- (a) State what is meant by *an e.m.f. of 1.5 V*. 1
- (b) (i) Show that the lost volts in the battery is 0.35 V. 2
Space for working and answer
- (ii) Determine the reading on the voltmeter. 1
Space for working and answer
- (iii) Calculate the power dissipated by the lamp. 3
Space for working and answer



12. (continued)

- (c) In a different circuit, an LED is connected to a battery containing four cells.

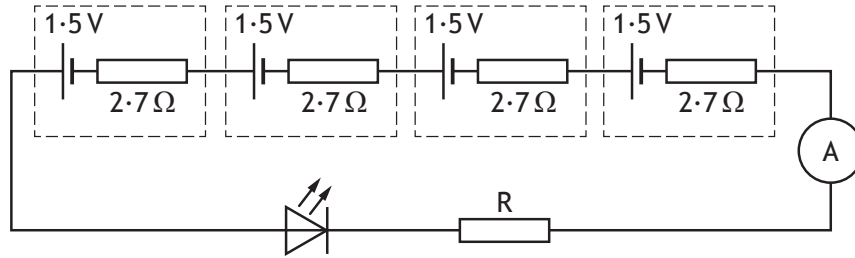

The potential difference across the LED is 3.6 V when the current is 26 mA.

Determine the resistance of resistor R.

Space for working and answer

4



Question		Answer	Max mark	Additional guidance	
12.	(a)	1.5 J (of energy) is <u>supplied to/gained by</u> each coulomb (of charge passing through the cell).	1	Accept 'given to'... Accept 'battery'/'source'.	
	(b)	(i)	lost volts = Ir 1 lost volts = $64 \times 10^{-3} \times (2 \times 2.7)$ 1 lost volts = 0.35 V	2	"SHOW" question. Must start with a correct formula. Accept $V = IR$ Accept 5.4 as substitution for 'r' Accept working out lost volts for one cell, then doubling.
		(ii)	$V = 2.7 V$	1	Must use 0.35 V Do not accept 3V on its own, but if 3V is clearly shown as a rounded value - 1 mark.
		(iii)	$P = IV$ 1 $P = 64 \times 10^{-3} \times 2.7$ 1 $P = 0.17 W$ 1	3	Or consistent with (b)(ii) Sig figs: Accept 0.2, 0.173, 0.1728

Question		Answer	Max mark	Additional guidance
12.	(c)	$V = E - Ir$ $V = 6.0 - (26 \times 10^{-3} \times (4 \times 2.7))$ 1 $V = 5.7192 (V)$ $R = \frac{V_R}{I}$ (both formulae) 1 $R = \frac{5.7192 - 3.6}{26 \times 10^{-3}}$ 1 $R = 82 \Omega$ 1	4	1 mark for quoting both formulae - explicitly or implied. Sig figs: Accept 80, 81.5, 81.51 Alternative methods: $R_T = \frac{V}{I}$ $R_T = \frac{6.0}{26 \times 10^{-3}} = 230.8(\Omega)$ $R_{LED} = \frac{V}{I}$ $R_{LED} = \frac{3.6}{26 \times 10^{-3}} = 138.5(\Omega)$ $R = 230.8 - (138.5 + 10.8)$ $R = 82 \Omega$ $V = Ir$ $V = 26 \times 10^{-3} \times (2.7 \times 4)$ $V = 0.2808 (V)$ $V_R = 6.0 - 3.6 - 0.2808$ $V_R = 2.1192 (V)$ $R = \frac{V_R}{I}$ $R = \frac{2.1192}{26 \times 10^{-3}}$ $R = 82 \Omega$ 1 mark for <u>all</u> formulae 1 mark for <u>all</u> substitutions 1 mark for <u>all</u> correct intermediate values 1 mark for final answer

13. An uncharged $220\ \mu\text{F}$ capacitor is connected in a circuit as shown.

MARKS
DO NOT
WRITE IN
THIS
MARGIN

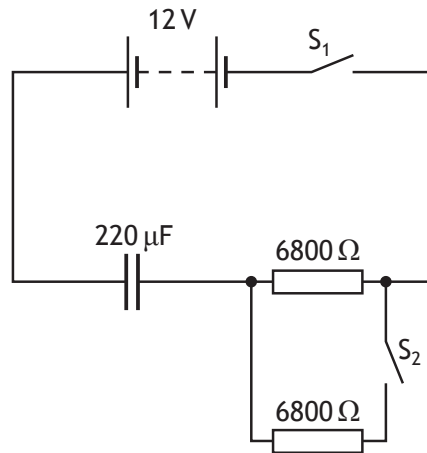

The 12 V battery has negligible internal resistance.

- (a) Switch S_1 is closed and the capacitor charges in a time of 7.5 s.

Calculate the initial charging current.

3

Space for working and answer

- (b) Switch S_1 is opened.

The capacitor is discharged.

Switch S_2 is now closed and then switch S_1 is closed.

Explain why the time for the capacitor to fully charge is less than in part (a).

2



* X 7 5 7 7 6 0 1 3 1 *

Question		Answer	Max mark	Additional guidance
13.	(a)	$V = IR$ $12 = I \times 6800$ $I = 1.8 \times 10^{-3} A$	<p>1</p> <p>1</p> <p>1</p>	<p>3</p> <p>Sig figs: Accept 2, 1.76, 1.765</p>
	(b)	<p>The (circuit/total) resistance is less</p> <p><u>Initial</u> charging current is greater</p>	<p>1</p> <p>1</p>	<p>2</p> <p>Independent marks.</p> <p>Accept:</p> <p><u>Average</u> current is greater OR The current <u>at any given time</u> is greater.</p> <p>'Current greater' on its own is not sufficient for 2nd mark.</p>

14. Solar cells are made by joining n-type and p-type semiconductor materials. A layer is formed at the junction between the materials.

(a) A potential difference is produced when photons enter the layer between the p-type and n-type materials.

State the name of this effect.

1

(b) A student carries out an experiment using a solar cell connected to a variable resistor R as shown.

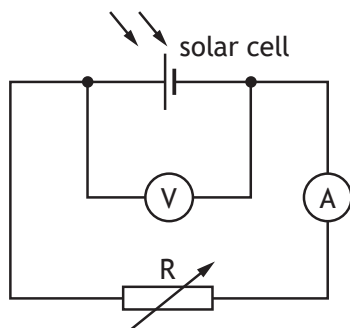

A lamp is placed above the solar cell and switched on.

The variable resistor is altered and readings of current and voltage are taken. These readings are used to produce the following graph.

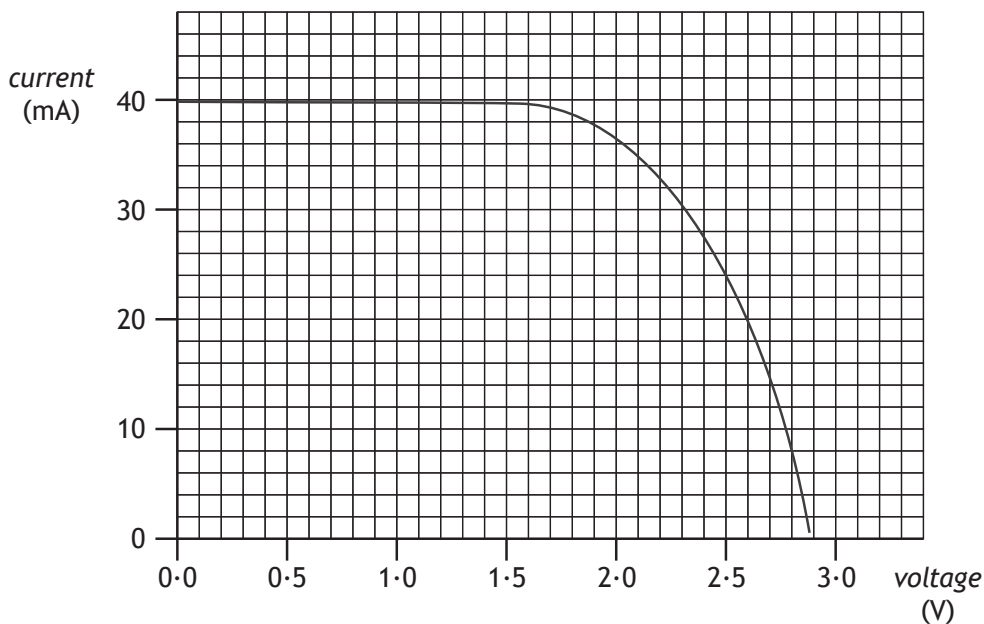

14. (b) (continued)

- (i) Solar cells have a maximum power output for a particular irradiance of light.

In this experiment, the maximum power output occurs when the voltage is 2.1 V.

Use information from the graph to estimate a value for the maximum power output from the solar cell.

Space for working and answer

3

- (ii) The lamp is now moved closer to the solar cell.

Explain, in terms of photons, why the maximum output power from the solar cell increases.

1



Question	Answer	Max mark	Additional guidance
----------	--------	----------	---------------------

14.	(a)		Photovoltaic (effect)	1	
	(b)	(i)	$I = 35 \text{ mA}$ (from graph) 1 $P = IV$ 1 $(P = 0.035 \times 2.1)$ $P = 0.074 \text{ W}$ 1	3	$P = IV$ anywhere, 1 mark. Sig figs: Accept 0.07, 0.0735 Accept a value for I between 34.5 and 35 mA inclusive. $I = 34.5 \text{ mA}$ gives $P = 0.073 \text{ W}$ Sig figs for above: Accept 0.07, 0.0725, 0.07245
		(ii)	Greater number of <u>photons</u> (strike the solar cell) <u>per second</u>	1	The answer has to imply a 'rate'. Any correct statement followed by wrong physics, 0 marks.

15. A wire of length L and cross-sectional area A is shown.

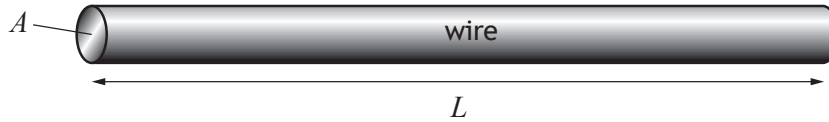

The resistance R of the wire is given by the relationship

$$R = \frac{\rho L}{A}$$

where ρ is the resistivity of the wire in $\Omega \text{ m}$.

- (a) The resistivity of aluminium is $2.8 \times 10^{-8} \Omega \text{ m}$.

Calculate the resistance of an aluminium wire of length 0.82 m and cross-sectional area $4.0 \times 10^{-6} \text{ m}^2$.

2

Space for working and answer



15. (continued)

MARKS
DO NOT
WRITE IN
THIS
MARGIN

- (b) A student carries out an investigation to determine the resistivity of a cylindrical metal wire of cross-sectional area $4.52 \times 10^{-6} \text{ m}^2$.

$$4.52 \times 10^{-6} \text{ m}^2$$



The student varies the length L of the wire and measures the corresponding resistance R of the wire.

The results are shown in the table.

Length of wire L (m)	Resistance of wire R ($\times 10^{-3} \Omega$)
1.5	5.6
2.0	7.5
2.5	9.4
3.0	11.2
3.5	13.2

- (i) Using the square-ruled paper on *Page 36*, draw a graph of R against L . 3
- (ii) Calculate the gradient of your graph. 2
Space for working and answer
- (iii) Determine the resistivity of the metal wire. 3
Space for working and answer

[END OF QUESTION PAPER]



* X 7 5 7 7 6 0 1 3 5 *

Question		Answer	Max mark	Additional guidance
15.	(a)	$R = \frac{\rho L}{A}$ $R = \frac{2.8 \times 10^{-8} \times 0.82}{4.0 \times 10^{-6}}$ $R = 5.7 \times 10^{-3} \Omega$	2 1 1	Sig figs: Accept 6×10^{-3} , 5.74×10^{-3} , 5.740×10^{-3}
	(b)	(i)	3 1 1	The scale must correctly extend over the range of the points plotted. The resistance scale must include ($\times 10^{-3}$) or show correct converted values, otherwise maximum 2 marks. If an invalid scale is used on either axis eg values for resistance from the table are used as major grid line values - 0 marks. Accuracy of plotting should be easily checkable with scale chosen. If the origin on an axis is shown, the scale must either be continuous or the axis must be 'broken'. Otherwise maximum 2 marks. Do not penalise if candidates plot L against R .

Question			Answer	Max mark	Additional guidance
15.	(b)	(ii)	<p>Choosing 2 points on <u>their</u> line 1</p> <p>Calculate gradient : accept value between 3.7×10^{-3} and 4.0×10^{-3} (Ωm^{-1}) 1</p> <p>(min 1 sig fig, max 4 sig figs)</p>	2	<p>Must be consistent with graph drawn for (b)(i). Candidates are asked to calculate the gradient of their graph.</p> <p>Calculated value must be consistent with the points selected.</p> <p>Data points $x=3.0$ and 3.5 give an acceptable gradient of 4.0×10^{-3}.</p> <p>If the scale points <u>do not</u> lie on the line drawn outwith $\pm \frac{1}{2}$ box tolerance, the scale points cannot be used to calculate the gradient.</p> <p>If ($\times 10^{-3}$) is not included in the final answer, maximum 1 mark unless this being omitted is consistent with the graph drawn in (b)(i).</p> <p>Unit is not required, but must be correct if stated and be consistent with graph drawn, otherwise maximum 1 mark.</p>



National
Qualifications
2018

X757/76/02

**Physics
Section 1 — Questions**

TUESDAY, 8 MAY

9:00 AM – 11:30 AM

Instructions for the completion of Section 1 are given on *page 02* of your question and answer booklet X757/76/01.

Record your answers on the answer grid on *page 03* of your question and answer booklet.

Reference may be made to the Data Sheet on *page 02* of this booklet and to the Relationships Sheet X757/76/11.

Before leaving the examination room you must give your question and answer booklet to the Invigilator; if you do not, you may lose all the marks for this paper.



DATA SHEET

COMMON PHYSICAL QUANTITIES

Quantity	Symbol	Value	Quantity	Symbol	Value
Speed of light in vacuum	c	$3.00 \times 10^8 \text{ m s}^{-1}$	Planck's constant	h	$6.63 \times 10^{-34} \text{ J s}$
Magnitude of the charge on an electron	e	$1.60 \times 10^{-19} \text{ C}$	Mass of electron	m_e	$9.11 \times 10^{-31} \text{ kg}$
Universal Constant of Gravitation	G	$6.67 \times 10^{-11} \text{ m}^3 \text{ kg}^{-1} \text{ s}^{-2}$	Mass of neutron	m_n	$1.675 \times 10^{-27} \text{ kg}$
Gravitational acceleration on Earth	g	9.8 m s^{-2}	Mass of proton	m_p	$1.673 \times 10^{-27} \text{ kg}$
Hubble's constant	H_0	$2.3 \times 10^{-18} \text{ s}^{-1}$			

REFRACTIVE INDICES

The refractive indices refer to sodium light of wavelength 589 nm and to substances at a temperature of 273 K.

Substance	Refractive index	Substance	Refractive index
Diamond	2.42	Water	1.33
Crown glass	1.50	Air	1.00

SPECTRAL LINES

Element	Wavelength/nm	Colour	Element	Wavelength/nm	Colour
Hydrogen	656	Red	Cadmium	644	Red
	486	Blue-green		509	Green
	434	Blue-violet		480	Blue
	410	Violet	Lasers		
	397	Ultraviolet	<i>Element</i>	<i>Wavelength/nm</i>	<i>Colour</i>
	389	Ultraviolet	Carbon dioxide	9550 } 10590 }	Infrared
Sodium	589	Yellow	Helium-neon	633	Red

PROPERTIES OF SELECTED MATERIALS

Substance	Density/kg m ⁻³	Melting Point/K	Boiling Point/K
Aluminium	2.70×10^3	933	2623
Copper	8.96×10^3	1357	2853
Ice	9.20×10^2	273
Sea Water	1.02×10^3	264	377
Water	1.00×10^3	273	373
Air	1.29
Hydrogen	9.0×10^{-2}	14	20

The gas densities refer to a temperature of 273 K and a pressure of $1.01 \times 10^5 \text{ Pa}$.

SECTION 1 — 20 marks

Attempt ALL questions

1. A car is moving at a speed of 2.0 m s^{-1} .
 The car now accelerates at 4.0 m s^{-2} until it reaches a speed of 14 m s^{-1} .
 The distance travelled by the car during this acceleration is
- A 1.5 m
 B 18 m
 C 24 m
 D 25 m
 E 48 m.
2. A ball is dropped from rest and allowed to bounce several times.
 The graph shows how the velocity of the ball varies with time.

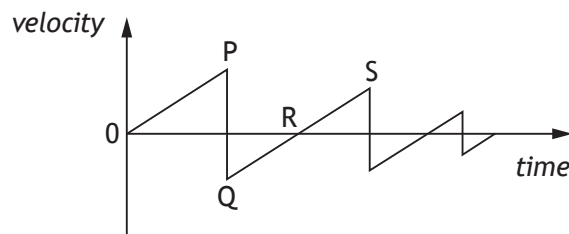

A student makes the following statements about the ball.

- I The ball hits the ground at P.
- II The ball is moving upwards between Q and R.
- III The ball is moving upwards between R and S.

Which of these statements is/are correct?

- A I only
- B II only
- C III only
- D I and II only
- E I and III only

[Turn over

3. A block of mass 6.0 kg and a block of mass 8.0 kg are connected by a string. A force of 32 N is applied to the blocks as shown.



A frictional force of 4.0 N acts on **each** block.

The acceleration of the 6.0 kg block is

- A 1.7 m s^{-2}
B 2.0 m s^{-2}
C 2.3 m s^{-2}
D 2.9 m s^{-2}
E 5.3 m s^{-2} .
4. A person stands on a weighing machine in a lift. When the lift is at rest, the reading on the weighing machine is 700 N.
The lift now descends and its speed increases at a constant rate.
The reading on the weighing machine
- A is a constant value higher than 700 N
B is a constant value lower than 700 N
C continually increases from 700 N
D continually decreases from 700 N
E remains constant at 700 N.
5. Enceladus is a moon of Saturn. The mass of Enceladus is $1.08 \times 10^{20} \text{ kg}$.
The mass of Saturn is $5.68 \times 10^{26} \text{ kg}$.
The gravitational force of attraction between Enceladus and Saturn is $7.24 \times 10^{19} \text{ N}$.
The orbital radius of Enceladus around Saturn is
- A $2.38 \times 10^8 \text{ m}$
B $9.11 \times 10^{13} \text{ m}$
C $5.65 \times 10^{16} \text{ m}$
D $8.30 \times 10^{27} \text{ m}$
E $3.19 \times 10^{33} \text{ m}$.

6. A spacecraft is travelling at $0.10c$ relative to a star.

An observer on the spacecraft measures the speed of light emitted by the star to be

- A $0.90c$
- B $0.99c$
- C $1.00c$
- D $1.01c$
- E $1.10c$.

7. A spacecraft is travelling at a speed of $0.200c$ relative to the Earth.

The spacecraft emits a signal for 20.0 seconds as measured in the frame of reference of the spacecraft.

An observer on Earth measures the duration of the signal as

- A 19.2 s
- B 19.6 s
- C 20.0 s
- D 20.4 s
- E 20.8 s.

8. How many types of quark are there?

- A 8
- B 6
- C 4
- D 3
- E 2

9. An electron is a

- A boson
- B hadron
- C baryon
- D meson
- E lepton.

[Turn over

10. A proton enters a region of magnetic field as shown.

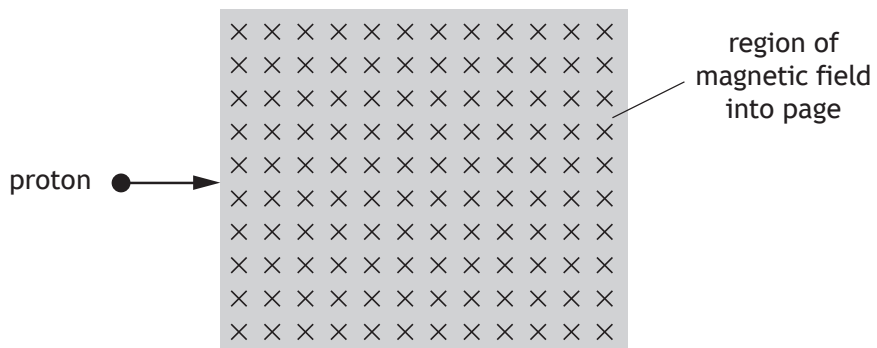

On entering the magnetic field the proton

- A deflects into the page
 - B deflects out of the page
 - C deflects towards the top of the page
 - D deflects towards the bottom of the page
 - E is not deflected.
11. A nuclear fission reaction is represented by the following statement.

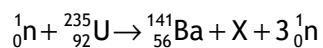

The nucleus represented by X is

- A ${}_{40}^{96}\text{Zr}$
 - B ${}_{36}^{92}\text{Kr}$
 - C ${}_{40}^{97}\text{Zr}$
 - D ${}_{36}^{93}\text{Kr}$
 - E ${}_{40}^{94}\text{Zr}$.
12. The irradiance on a surface 0.50 m from a point source of light is I .
The irradiance on a surface 1.5 m from this source is
- A 0.11 I
 - B 0.33 I
 - C 1.5 I
 - D 3.0 I
 - E 9.0 I .

13. Waves from two coherent sources, S_1 and S_2 , produce an interference pattern. Maxima are detected at the positions shown below.

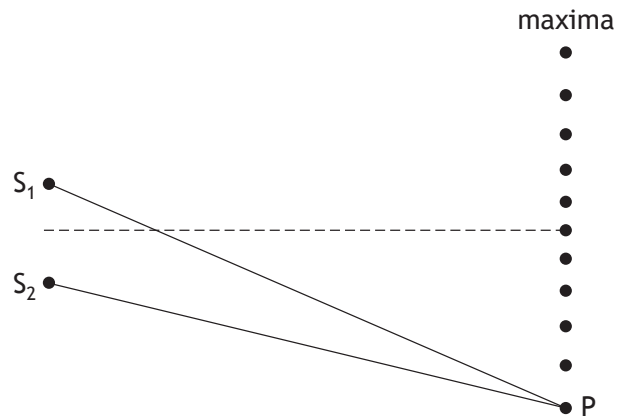

The path difference $S_1P - S_2P$ is 154 mm.

The wavelength of the waves is

- A 15.4 mm
- B 25.7 mm
- C 28.0 mm
- D 30.8 mm
- E 34.2 mm.

[Turn over

14. A ray of monochromatic light passes from air into a block of glass as shown.

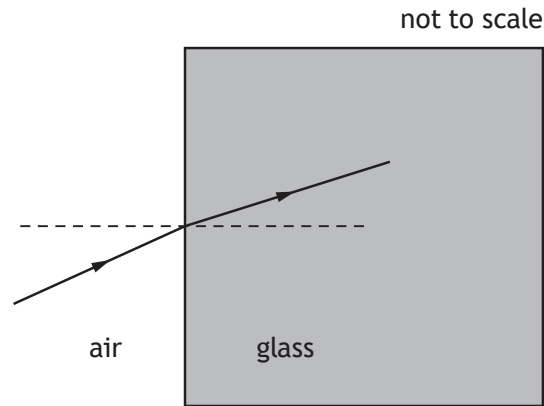

The wavelength of this light in air is 6.30×10^{-7} m.

The refractive index of the glass for this light is 1.50.

The frequency of this light in the glass is

- A 2.10×10^{-15} Hz
- B 1.26×10^2 Hz
- C 1.89×10^2 Hz
- D 4.76×10^{14} Hz
- E 7.14×10^{14} Hz.

15. A circuit is set up as shown.

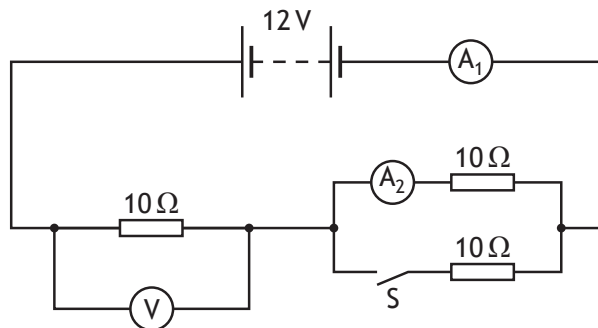

The battery has negligible internal resistance.

A student makes the following statements about the readings on the meters in this circuit.

- I When switch S is open the reading on the voltmeter will be 6.0 V.
- II When switch S is open the reading on A_2 will be 0.60 A.
- III When switch S is closed the reading on A_1 will be 0.80 A.

Which of these statements is/are correct?

- A I only
 - B II only
 - C I and II only
 - D II and III only
 - E I, II and III
16. The power dissipated in a $120\ \Omega$ resistor is 4.8 W.

The current in the resistor is

- A 0.020 A
- B 0.040 A
- C 0.20 A
- D 5.0 A
- E 25 A.

[Turn over

17. A $24.0\ \mu\text{F}$ capacitor is charged until the potential difference across it is $125\ \text{V}$.
The charge stored on the capacitor is

- A $5.21 \times 10^6\ \text{C}$
- B $7.75 \times 10^{-2}\ \text{C}$
- C $1.50 \times 10^{-3}\ \text{C}$
- D $3.00 \times 10^{-3}\ \text{C}$
- E $1.92 \times 10^{-7}\ \text{C}$.

18. A circuit is set up as shown.

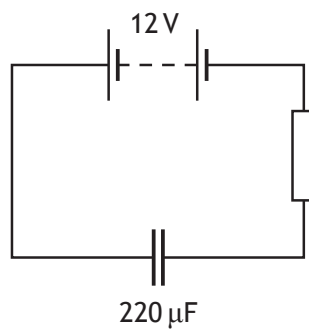

When the capacitor is fully charged the energy stored in the capacitor is

- A $1.6 \times 10^{-5}\ \text{J}$
- B $1.3 \times 10^{-3}\ \text{J}$
- C $2.6 \times 10^{-3}\ \text{J}$
- D $1.6 \times 10^{-2}\ \text{J}$
- E $1.6 \times 10^4\ \text{J}$.

19. The circuit shown is used to charge and then discharge a capacitor C.

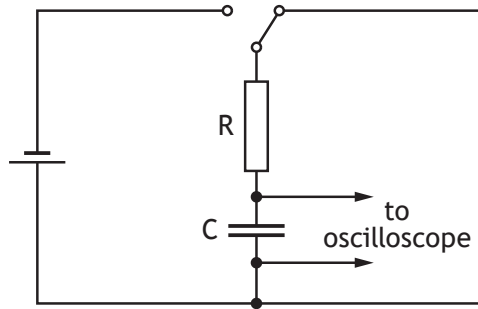

Which pair of graphs shows how the potential difference V across the capacitor varies with time t during charging and discharging?

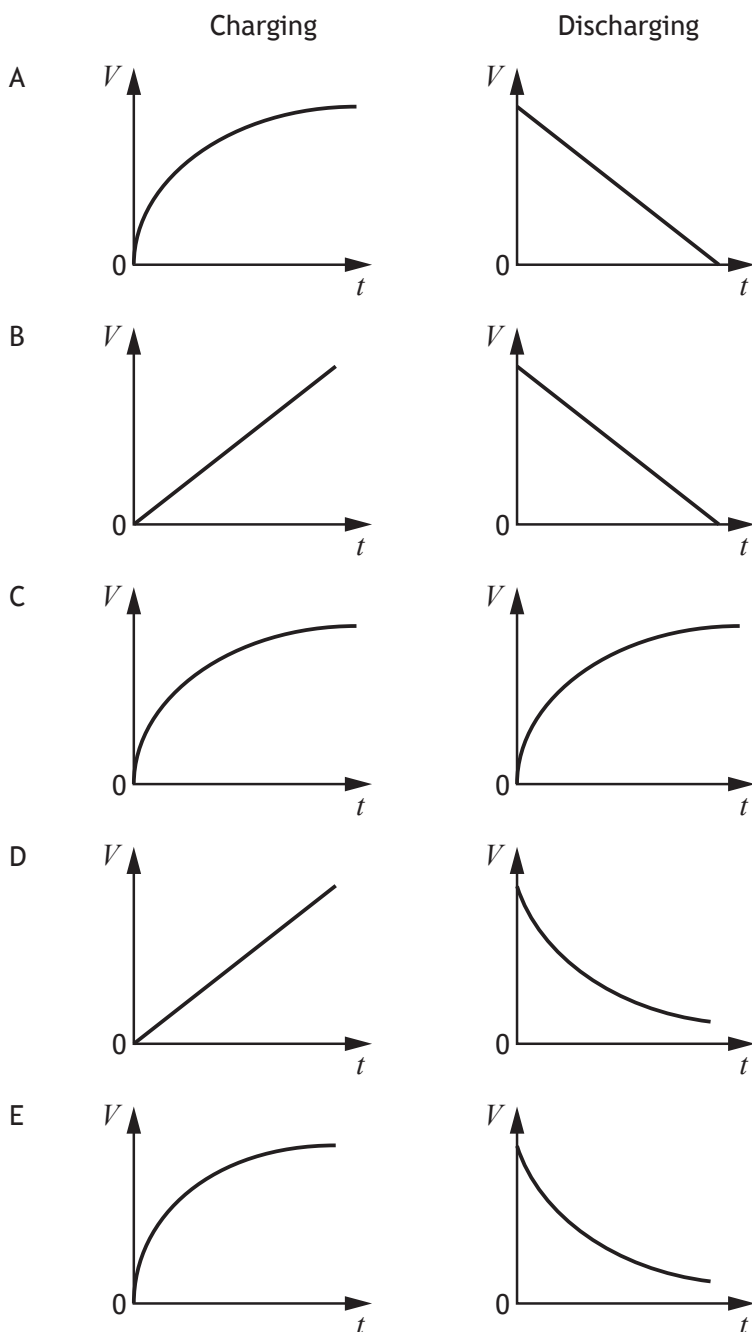

20. A student carries out an experiment to determine the specific heat capacity c of a solid. The relationship used to calculate c is

$$c = \frac{E}{m\Delta T}$$

The recorded measurements and their percentage uncertainties are shown.

energy supplied, $E = 5000 \text{ J} \pm 1\%$

mass of solid, $m = 0.20 \text{ kg} \pm 2\%$

change in temperature, $\Delta T = 4.5 \text{ }^\circ\text{C} \pm 5\%$

A good estimate of the percentage uncertainty in the calculated value of c is

- A 8%
- B 7%
- C 5%
- D 3%
- E 1%.

**[END OF SECTION 1. NOW ATTEMPT THE QUESTIONS IN SECTION 2
OF YOUR QUESTION AND ANSWER BOOKLET]**

Marking instructions for each question

Section 1

Question	Answer	Mark
1.	C	1
2.	D	1
3.	A	1
4.	B	1
5.	A	1
6.	C	1
7.	D	1
8.	B	1
9.	E	1
10.	C	1
11.	B	1
12.	A	1
13.	D	1
14.	D	1
15.	E	1
16.	C	1
17.	D	1
18.	D	1
19.	E	1
20.	C	1



FOR OFFICIAL USE

--	--	--	--	--	--

National
Qualifications
2018

Mark

--

X757/76/01

**Physics
Section 1 — Answer Grid
and Section 2**

TUESDAY, 8 MAY

9:00 AM – 11:30 AM



* X 7 5 7 7 6 0 1 *

Fill in these boxes and read what is printed below.

Full name of centre

--

Town

--

Forename(s)

--

Surname

--

Number of seat

--

Date of birth

Day

--	--

Month

--	--

Year

--	--

Scottish candidate number

--	--	--	--	--	--	--	--	--	--

Total marks — 130

SECTION 1 — 20 marks

Attempt ALL questions.

Instructions for the completion of Section 1 are given on *page 02*.

SECTION 2 — 110 marks

Attempt ALL questions.

Reference may be made to the Data Sheet on *page 02* of the question paper X757/76/02 and to the Relationships Sheet X757/76/11.

Care should be taken to give an appropriate number of significant figures in the final answers to calculations.

Write your answers clearly in the spaces provided in this booklet. Additional space for answers and rough work is provided at the end of this booklet. If you use this space you must clearly identify the question number you are attempting. Any rough work must be written in this booklet. You should score through your rough work when you have written your final copy.

Use **blue** or **black** ink.

Before leaving the examination room you must give this booklet to the Invigilator; if you do not, you may lose all the marks for this paper.



* X 7 5 7 7 6 0 1 0 1 *

SECTION 2 — 110 marks

Attempt ALL questions

1. During a school funfair, a student throws a wet sponge at a teacher. The sponge is thrown with an initial velocity of 7.4 m s^{-1} at an angle of 30° to the horizontal.

The sponge leaves the student's hand at a height of 1.5 m above the ground.

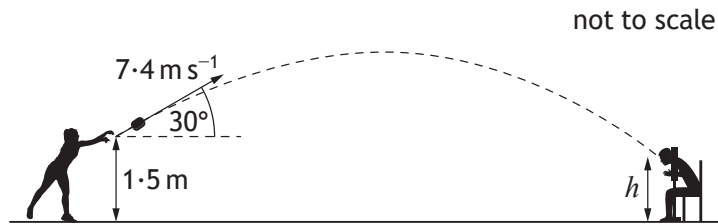

The sponge hits the teacher.

The effects of air resistance can be ignored.

- (a) (i) Calculate:

- (A) the horizontal component of the initial velocity of the sponge; **1**

Space for working and answer

- (B) the vertical component of the initial velocity of the sponge. **1**

Space for working and answer



1. (a) (continued)

- (ii) Calculate the time taken for the sponge to reach its maximum height.

3

Space for working and answer

- (iii) The sponge takes a further 0.45 s to travel from its maximum height until it hits the teacher.

4

Determine the height h above the ground at which the sponge hits the teacher.

Space for working and answer

- (b) The student throwing the sponge makes the following statement.

“If the sponge is thrown with a higher speed at the same angle from the same height then it would take a shorter time to hit the teacher in the same place.”

Explain why the student’s statement is incorrect.

2



* X 7 5 7 7 6 0 1 0 7 *

Section 2

Question			Answer	Max mark	Additional guidance
1.	(a)	(i) (A)	$u_h = 7.4 \cos 30$ $u_h = 6.4 \text{ m s}^{-1}$ (1)	1	Accept: 6, 6.41, 6.409
		(i) (B)	$u_v = 7.4 \sin 30$ $u_v = 3.7 \text{ m s}^{-1}$ (1)	1	Accept: 4, 3.70, 3.700
		(ii)	$v = u + at$ (1) $0 = 3.7 + (-9.8)t$ (1) $t = 0.38 \text{ s}$ (1)	3	OR consistent with (a)(i)(B) u and a must have opposite signs Accept: 0.4, 0.378, 0.3776
		(iii)	$s = ut + \frac{1}{2}at^2$ (1) $s = (3.7 \times 0.83) + (0.5 \times -9.8 \times 0.83^2)$ (1) $h = 1.5 + ((3.7 \times 0.83) \times (0.5 \times -9.8 \times 0.83^2))$ (1) $h = 1.2 \text{ m}$ (1)	4	OR consistent with (a)(i)(B) and (a)(ii) Accept: 1, 1.20, 1.195 For alternative methods 1 mark for ALL relationships 1 mark for ALL substitutions 1 mark for addition relative to 1.5m 1 mark for final answer $s = \frac{1}{2}(u + v)t$ $s = \frac{1}{2} \times (3.7 + 0) \times 0.38$ $s = ut + \frac{1}{2}at^2$ $s = (0 \times 0.45) + (0.5 \times -9.8 \times 0.45^2)$ $h_{\max} = 1.5 + \left(\frac{1}{2} \times (3.7 + 0) \times 0.38\right)$ $h_{\max} = 2.203 \text{ (m)}$ $h = 2.203 + (0.5 \times -9.8 \times 0.45^2)$ $h = 1.2 \text{ m}$ Accept 1, 1.21, 1.211 for this method.

Question		Answer	Max mark	Additional guidance
1.	(b)	<p>(Initial) vertical/horizontal speed is greater. (1)</p> <p>Sponge is higher than the teacher when it has travelled the same horizontal distance.</p> <p>OR</p> <p>Sponge has travelled further horizontally when it is at the same height as the teacher. (1)</p>	2	Look for this statement first - if incorrect or missing then 0 marks.

2. An internet shopping company is planning to use drones to deliver packages.

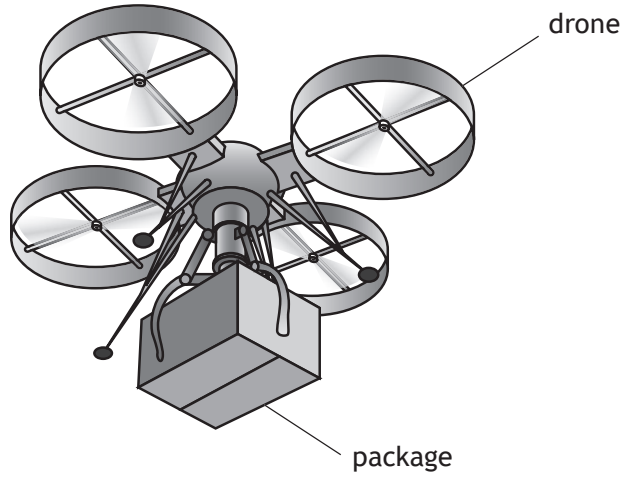

- (a) During a test the drone is hovering at a constant height above the ground.
The mass of the drone is 5.50 kg.
The mass of the package is 1.25 kg.
- (i) Determine the upward force produced by the drone.
- Space for working and answer*

3



2. (a) (continued)

(ii) The package is now lowered using a motor and a cable.

A battery supplies 12 V across the motor. The resistance of the motor is 9.6Ω .

Calculate the power dissipated by the motor.

3

Space for working and answer

(iii) While the package is being lowered the cable breaks.

The upward force produced by the drone remains constant.

Describe the vertical motion of the drone immediately after the cable breaks.

2

Justify your answer.

[Turn over



* X 7 5 7 7 6 0 1 0 9 *

2. (continued)

(b) To carry a package with a greater mass two drones are used as shown.

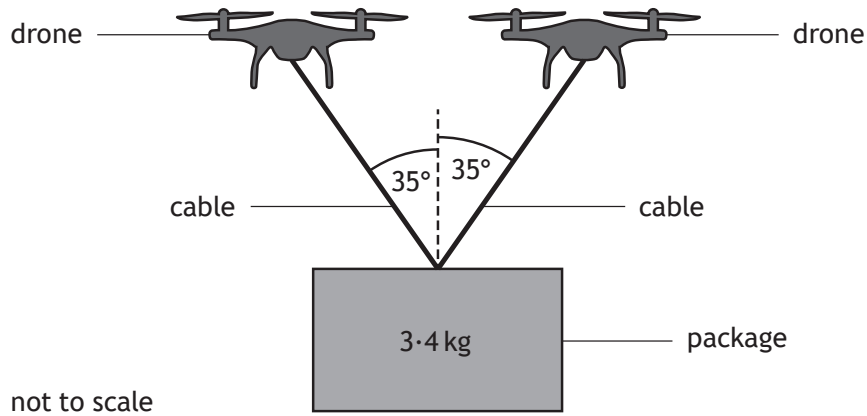

The drones are hovering at a constant height above the ground.
 The mass of the package suspended from the two drones is 3.4 kg.
 Determine the tension in each cable.
Space for working and answer

4



Question			Answer	Max mark	Additional guidance
2.	(a)	(i)	$W = mg$ (1) $W = (5 \cdot 50 + 1 \cdot 25) \times 9 \cdot 8$ (1) $W = 66 \text{ N}$ (1)	3	Accept: 70, 66·2, 66·15 In <u>this</u> question, ignore negative signs in both the substitution and final answer for weight. Do not accept: $F = ma$
		(ii)	$P = \frac{V^2}{R}$ (1) $P = \frac{12^2}{9 \cdot 6}$ (1) $P = 15 \text{ W}$ (1)	3	Accept: 20, 15·0, 15·00 For alternative methods 1 mark for ALL relationships 1 mark for ALL substitutions 1 mark for final answer
		(iii)	Drone <u>accelerates upwards</u> (1) Upward force is greater than weight OR (Upward force remains constant but) weight decreases therefore forces are no longer balanced. OR (Upward force remains constant but) weight decreases therefore there is an unbalanced force (upwards). (1)	2	Look for correct statement of effect first - if incorrect or missing then 0 marks. Accept free-body diagram to aid description of relative size and direction of forces acting on the drone.

Question		Answer	Max mark	Additional guidance
2.	(b)	$W = mg$ $W = 3.4 \times 9.8$ $W = 33.32 \text{ (N)}$	4	Accept: 20.3, 20.34 Accept: $F \sin 55 = 16.66$ $F = 20 \text{ N}$ Alternative methods: Each cord supports $3.4/2 = 1.7 \text{ (kg)}$ (1) $W = mg$ $W = 1.7 \times 9.8$ $W = 16.66 \text{ (N)}$ (1) $F \cos 35 = 16.66$ (1) $F = 20 \text{ N}$ (1) OR $W = mg$ $W = 3.4 \times 9.8$ $W = 33.32 \text{ (N)}$ (1) $F \cos 35 = 33.32$ (1) Tension in each cord $= 40.6762093/2 = 20 \text{ N}$ (1)

3. A student sets up an experiment to investigate a collision between two vehicles on a frictionless air track.

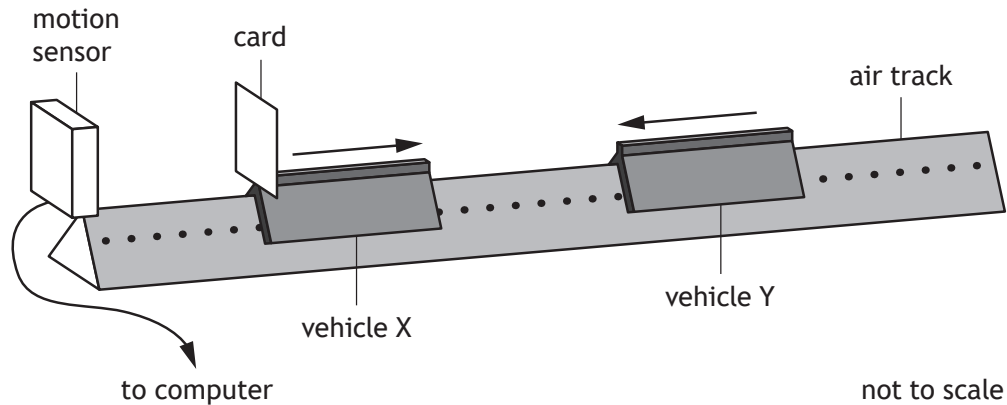

Vehicle X of mass 0.75 kg is travelling to the right along the track.

Vehicle Y of mass 0.50 kg is travelling to the left along the track with a speed of 0.30 m s^{-1} .

The vehicles collide and move off separately.

A computer displays a graph showing the velocity of vehicle X from just before the collision to just after the collision.

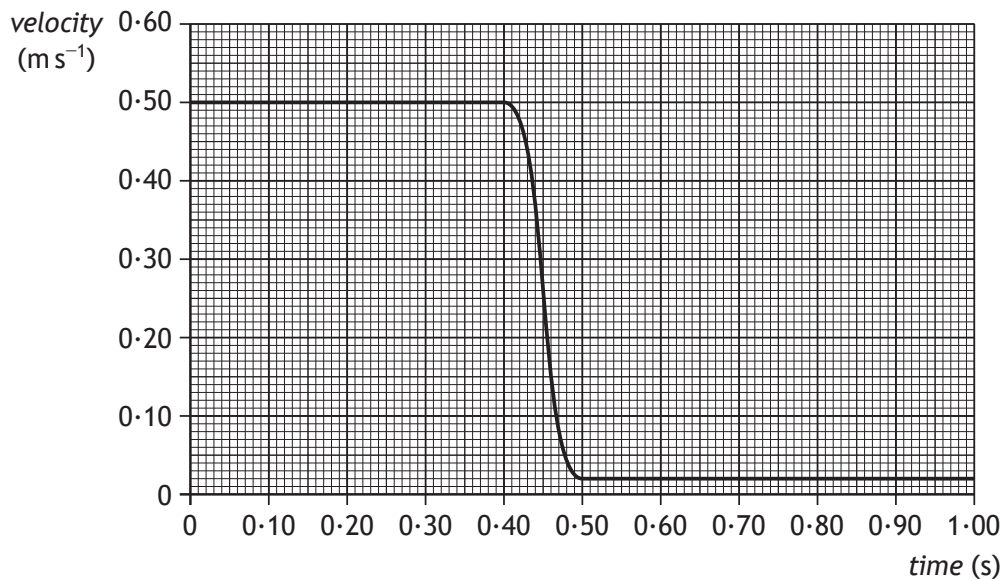

MARKS

DO NOT
WRITE IN
THIS
MARGIN

3. (continued)

- (a) Show that the velocity of vehicle Y after the collision is 0.42 m s^{-1} .
Space for working and answer

2

- (b) Determine the impulse on vehicle Y during the collision.
Space for working and answer

3

[Turn over



MARKS

DO NOT
WRITE IN
THIS
MARGIN

3. (continued)

- (c) Explain how the student would determine whether the collision was elastic or inelastic.

2



Question		Answer	Max mark	Additional guidance
3.	(a)	<p>(Total momentum before = Total momentum after)</p> $p = mv$ <p>OR (1)</p> $(m_x u_x + m_y u_y) = (m_x v_x + m_y v_y)$ $(0.75 \times 0.50) + (0.50 \times -0.30) = (0.75 \times 0.02) + (0.50 v_y)$ (1) $v_y = 0.42 \text{ m s}^{-1}$	2	<p>“SHOW” question</p> <p>If sign convention is not applied then max 1 mark for formula.</p>
	(b)	$Ft = mv - mu$ (1) $Ft = (0.50 \times 0.42) - (0.50 \times -0.30)$ (1) $Ft = 0.36 \text{ N s}$ (1)	3	<p>Accept: 0.4</p> <p>Accept: Impulse = $mv - mu$</p> <p>v and u must have opposite sign.</p> <p>Accept: kg m s^{-1}</p>
	(c)	<p>Calculate the <u>total</u> kinetic energy before and (<u>total</u> kinetic energy) after. (1)</p> <p>If E_k before is equal to E_k after the collision, is elastic.</p> <p>OR</p> <p>If E_k before is greater than E_k after, the collision is inelastic. (1)</p>	2	<p>Look for a statement relating to calculating/finding the <u>total</u> E_k before and after first, otherwise 0 marks.</p> <p>There must be an indication of total kinetic energy or equivalent term.</p> <p>Accept: If kinetic energy is not the same, collision is inelastic.</p> <p>Can show by calculation but would still require a statement for the second mark.</p> <p>Do not Accept: If kinetic energy is gained, collision is inelastic.</p> <p>If candidate says energy is lost then max 1 mark.</p>

4. A stunt is being carried out during the making of a film.

A car is to be driven up a ramp on a moving lorry by a stunt driver, who will attempt to land the car safely on the roof of a second moving lorry. The car is to stop on the roof of the second lorry while this lorry is still moving.

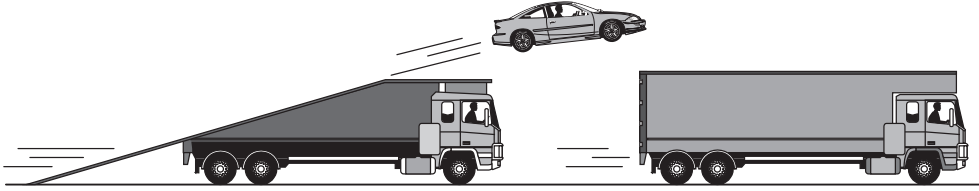

Using your knowledge of physics, comment on the challenges involved in carrying out the stunt successfully.

3

[Turn over



5. Hubble's Law states that the universe is expanding. The expanding universe is one piece of evidence that supports the Big Bang theory.

(a) State one other piece of evidence that supports the Big Bang theory.

1

(b) A student plots some of the original data from the 1929 paper by Edwin Hubble and adds the line shown in order to determine a value for the Hubble constant H_0 .

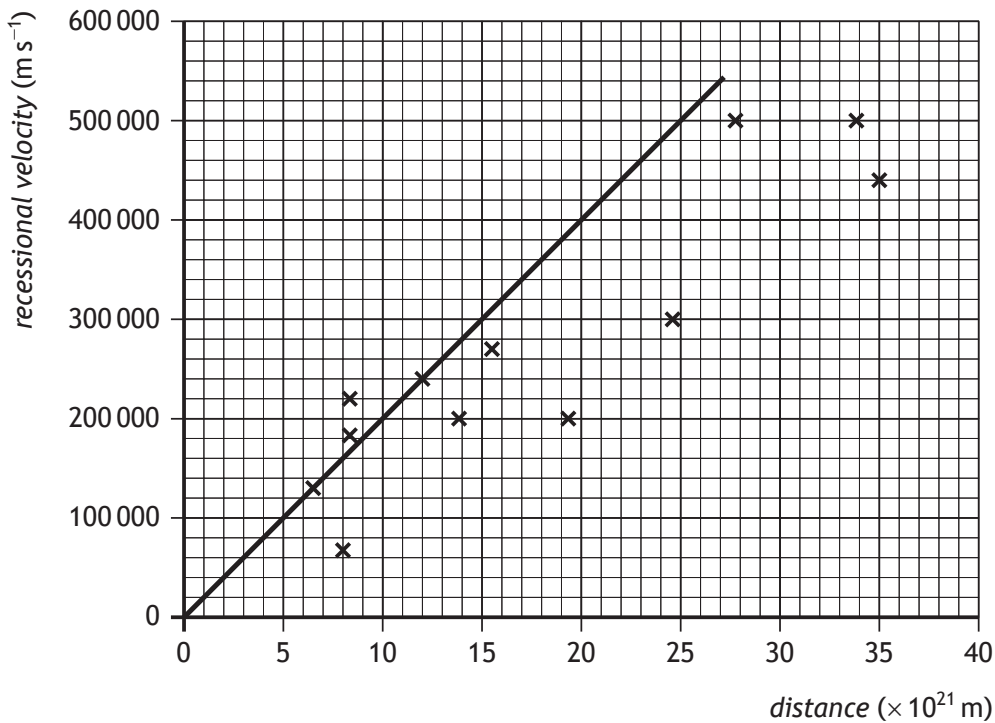

The student calculates the gradient of their line and obtains a value for the Hubble constant of $2.0 \times 10^{-17} \text{ s}^{-1}$.

The age of the universe can be calculated using the relationship

$$\text{age of universe} = \frac{1}{H_0}$$



5. (b) (continued)

- (i) Calculate the age of the universe, in years, obtained when using the student's value for the Hubble constant.

2

Space for working and answer

- (ii) The current estimate for the age of the universe is 13.8×10^9 years.

- (A) State why the value obtained in (b)(i) is different from the current estimate for the age of the universe.

1

- (B) Suggest a change that the student could make to their graph to obtain a value closer to the current estimate for the age of the universe.

1

- (c) It has been discovered that the rate of expansion of the universe is increasing.

State what physicists think is responsible for this increase.

1



* X 7 5 7 7 6 0 1 1 7 *

Question		Answer	Max mark	Additional guidance
5.	(a)	<p>Cosmic Microwave Background Radiation</p> <p>OR</p> <p>Olber's Paradox</p> <p>OR</p> <p>Abundance of Hydrogen and Helium in the Universe</p>	1	<p>Present temperature of the universe 2.7K (Blackbody radiation graph)</p> <p>Accept: Abundance of Light elements in the Universe</p> <p>Do not accept: the abbreviation "CMBR" on its own.</p> <p>Do not accept any further evidence based on redshift alone.</p>
	(b)	(i) $\left(\text{Age} = \frac{1}{H_0} \right)$ $\text{Age} = \frac{1}{2.0 \times 10^{-17}} \quad (1)$ $(\text{Age} = 5.0 \times 10^{16} \text{ (s)})$ $\text{Age} = 1.6 \times 10^9 \text{ (years)} \quad (1)$	2	<p>Accept: 2, 1.58, 1.584</p> <p>Accept: 2, 1.59, 1.585 (365 days has been used - this does not need to be shown explicitly.)</p> <p>Years in brackets as question asks for age "in years".</p>

Question			Answer	Max mark	Additional guidance
5.	(ii)	(A)	<p>(Student's) value for H_0 is incorrect/too large/not accurate (enough).</p> <p>OR</p> <p>Incorrect line (of best fit) drawn.</p> <p>OR</p> <p>The (student's) gradient (which is H_0) is too large.</p> <p>OR</p> <p>New/more data is available/more accurate.</p> <p>OR</p> <p>Not enough data at large distances.</p>	1	<p>Accept: H_0 varies/decreases as age of the universe increases</p> <p>Do not accept: H_0 is different</p>
		(B)	<p>The student could draw the (correct) line of best fit.</p> <p>OR</p> <p>Student could use a larger sample/all of the 1929 Hubble data.</p>	1	<p>Accept: The student could use current data.</p> <p>Do not accept "<u>different</u> line of best fit" alone.</p>
	(c)		Dark energy	1	

6. An experiment is set up to demonstrate a simple particle accelerator.

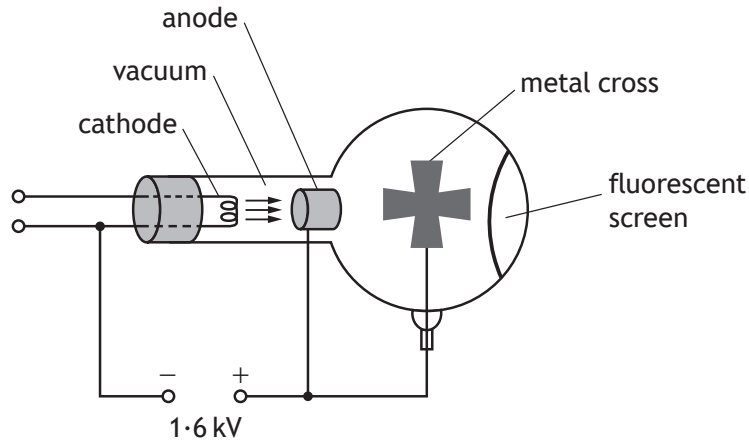

- (a) Electrons are accelerated from rest between the cathode and the anode by a potential difference of 1.6 kV.

- (i) Show that the work done in accelerating an electron from rest is 2.6×10^{-16} J.

2

Space for working and answer

- (ii) Calculate the speed of the electron as it reaches the anode.

3

Space for working and answer



* X 7 5 7 7 6 0 1 1 8 *

6. (continued)

- (b) As the electrons travel through the vacuum towards the fluorescent screen they spread out.

In the path of the electrons there is a metal cross, which is connected to the positive terminal of the supply. The electrons that hit the cross are stopped by the metal.

Electrons that get past the metal cross hit a fluorescent screen at the far side of the tube.

When electrons hit the fluorescent screen, the screen glows.

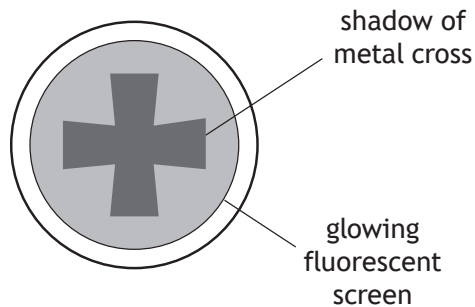

The potential difference between the anode and the cathode is now increased to 2.2 kV. This changes what is observed on the screen.

Suggest one change that is observed.

2

You must justify your answer.

[Turn over



6. (continued)

- (c) A student builds a model of a particle accelerator. The model accelerates a small ball on a circular track. A battery-operated motor accelerates the ball each time it passes the motor. To cause a collision a plastic block is pushed onto the track. The ball then hits the block.

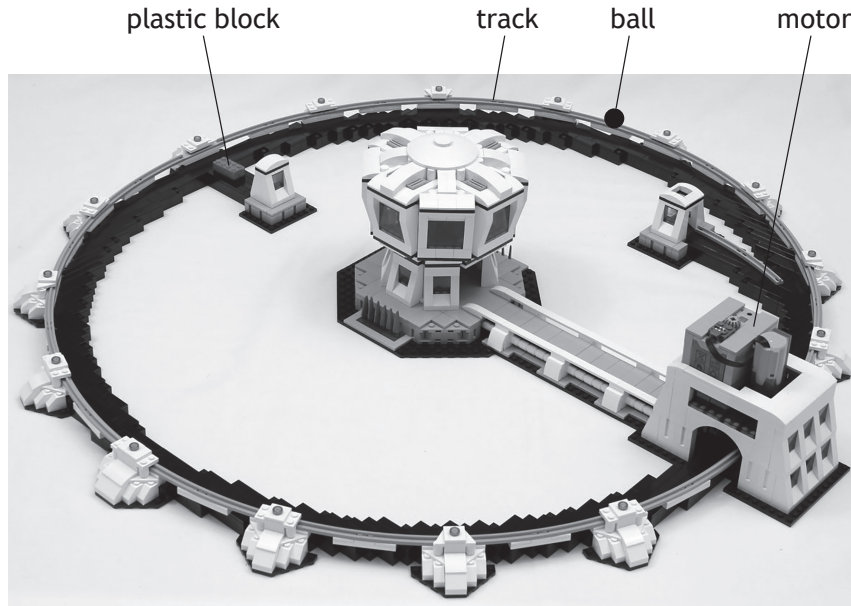

Using your knowledge of physics comment on the model compared to a real particle accelerator, such as the large hadron collider at CERN.

3



Question			Answer	Max mark	Additional guidance
6.	(a)	(i)	$W = QV$ (1) $W = 1.60 \times 10^{-19} \times 1600$ (1) $W = 2.6 \times 10^{-16} \text{ J}$	2	“SHOW” question
		(ii)	$E_k = \frac{1}{2}mv^2$ (1) $2.6 \times 10^{-16} = \frac{1}{2} \times 9.11 \times 10^{-31} \times v^2$ (1) $v = 2.4 \times 10^7 \text{ m s}^{-1}$ (1)	3	Accept: 2, 2.39, 2.389
	(b)		Screen will be brighter/increase glow. (1) Electrons will gain more energy/move faster. OR Increase in number of electrons <u>per second</u> . (1)	2	Look for correct statement of effect first - if incorrect or missing then 0 marks. Accept: Circle of brightness on fluorescent screen is reduced. (1) Greater force of attraction on the electrons due to the cross. (1) OR Cross on screen is sharper. (1) Greater force of attraction on the electrons due to the cross. (1) ‘increase in current’ alone is insufficient for the justification. Any correct statement followed by wrong physics, 0 marks. Any correct statement followed by no justification, 0 marks.

7. A student uses a gold-leaf electroscope to investigate the photoelectric effect. A deflection of the gold leaf on the electroscope shows that the metal plate is charged.

The student charges the metal plate on the electroscope and the gold leaf is deflected.

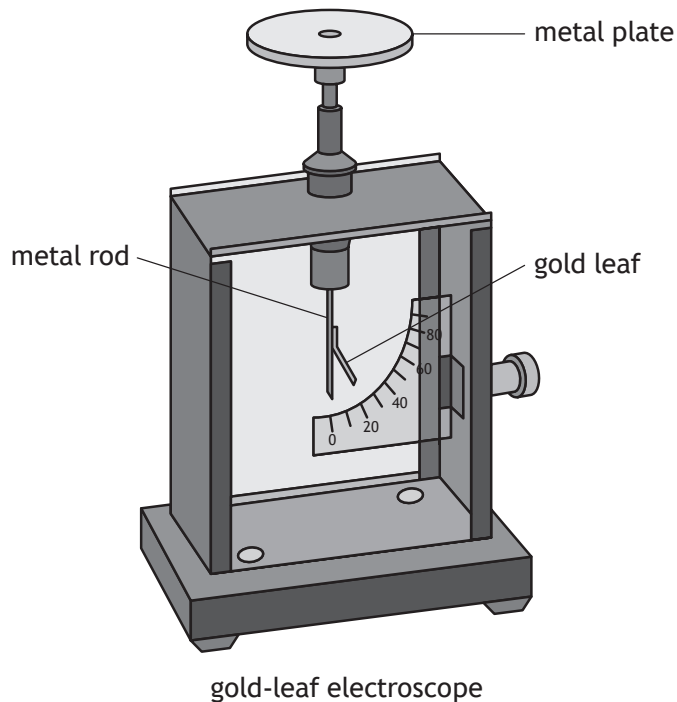

- (a) Ultraviolet light is shone onto the negatively charged metal plate. The gold-leaf electroscope does not discharge. This indicates that photoelectrons are not ejected from the surface of the metal.

Suggest one reason why photoelectrons are not ejected from the surface of the metal.

1



7. (continued)

- (b) The student adjusts the experiment so that the gold-leaf electroscope now discharges when ultraviolet light is shone onto the plate.

The work function for the metal plate is 6.94×10^{-19} J.

- (i) State what is meant by a *work function of 6.94×10^{-19} J*.

1

- (ii) The irradiance of the ultraviolet light on the metal plate is reduced by increasing the distance between the gold-leaf electroscope and the ultraviolet light source.

State what effect, if any, this has on the maximum kinetic energy of the photoelectrons ejected from the surface of the metal.

2

Justify your answer.

[Turn over



* X 7 5 7 7 6 0 1 2 3 *

7. (continued)

- (c) The graph shows how the kinetic energy of the photoelectrons ejected from the metal plate varies as the frequency of the incident radiation increases.

The threshold frequency for the metal plate is 1.05×10^{15} Hz.

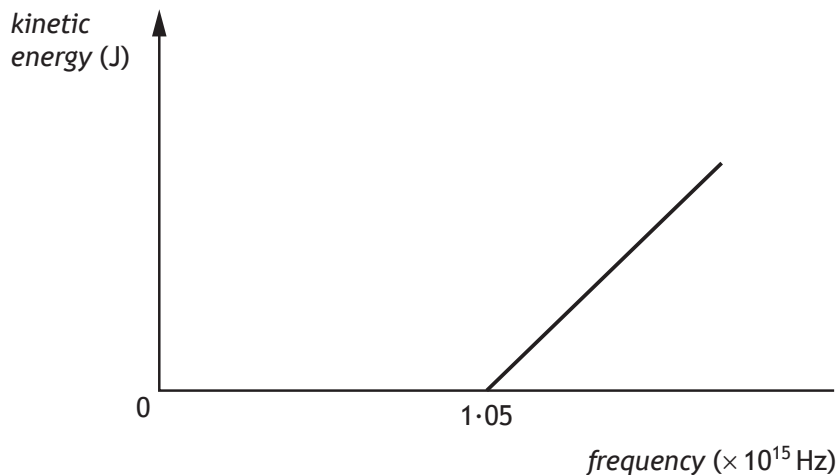

The metal plate is now replaced with a different metal plate made of aluminium.

The aluminium has a threshold frequency of 0.99×10^{15} Hz.

Add a line to the graph to show how the kinetic energy of the photoelectrons ejected from the aluminium plate varies as the frequency of the incident radiation increases.

2

(An additional graph, if required, can be found on page 45.)

- (d) Explain why the photoelectric effect provides evidence for the particle nature of light.

1



Question		Answer	Max mark	Additional guidance	
7.	(a)	<p>Frequency of <u>UV/photons/light</u> is not high enough.</p> <p>OR</p> <p>Frequency of <u>UV/photons/light</u> is less than threshold frequency.</p> <p>OR</p> <p>Energy of <u>photons</u> (of UV light) is not high enough.</p> <p>OR</p> <p>Energy of <u>photons</u> (of UV light) is less than work function.</p> <p>OR</p> <p>May not be a 'clean plate'.</p>	1	Do not accept "gold" for metal plate.	
	(b)	(i)	<p>6.94×10^{-19} joules of energy is the <u>minimum</u> energy required for (photo) electrons to be emitted/ejected/ photoemission (of electrons).</p>	1	Do not accept "to cause photoelectric effect" alone.
		(ii)	<p>No change (to the kinetic energy). (1)</p> <p>As the irradiance does not affect the energy of the photons/ $E = hf$ is unchanged. (1)</p>	2	Look for this first - if incorrect or missing then 0 marks.
	(c)	<p>Lower starting frequency. (1)</p> <p>Same gradient. (1)</p>	2	<p>Independent marks</p> <p>Do not accept: Additional line starting at origin.</p>	
	(d)	<p>Each photon contains a fixed/discrete amount of energy.</p> <p>OR</p> <p>Each photon removes one electron.</p>	1	<p>Some indication of quantisation of energy.</p> <p>If light was a wave then the photoelectric effect would occur regardless of the frequency of the light, it would just take longer for electrons to absorb the energy required to be ejected.</p>	

8. A student investigates interference of light by directing laser light of wavelength 630 nm onto a grating as shown.

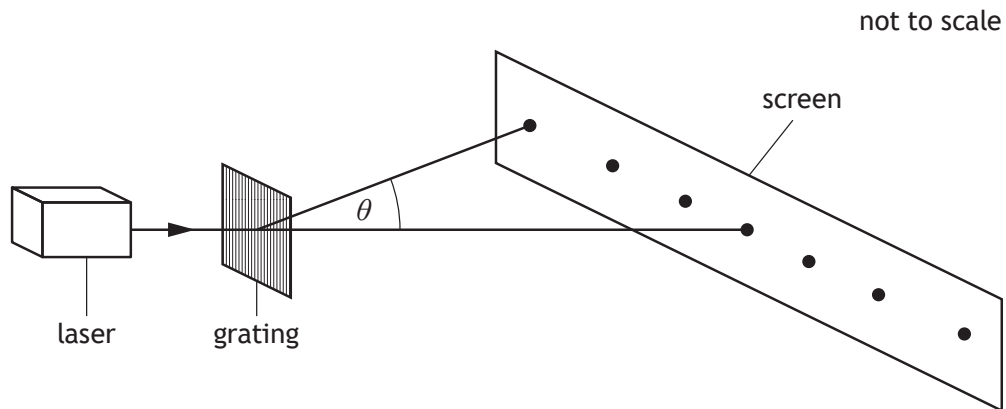

- (a) A pattern of bright spots is observed on a screen.
- (i) Explain, in terms of waves, how bright spots are produced on the screen. 1

- (ii) The grating has 250 lines per millimetre.
- Calculate the angle θ between the central maximum and the third order maximum. 3

Space for working and answer

[Turn over



MARKS DO NOT WRITE IN THIS MARGIN

8. (a) (continued)

(iii) The grating is now replaced by one which has 600 lines per millimetre.

State the effect of this change on the pattern observed.

2

Justify your answer.

(iv) The interference pattern is produced by coherent light.

State what is meant by the term *coherent*.

1



8. (continued)

(b) The student now shines light from the laser onto a £5 note.

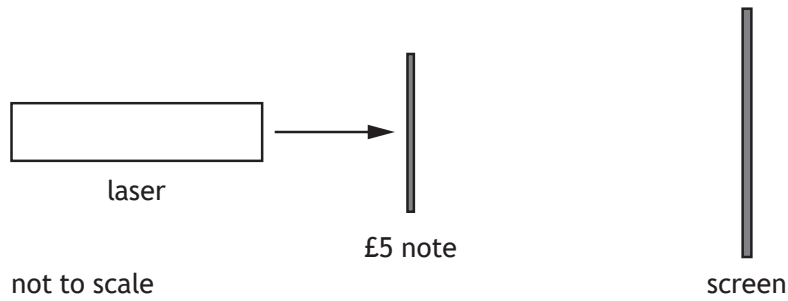

When it is shone through the transparent section of the note the student observes a pattern of bright spots on the screen.

The diagram below shows the pattern that the student observes on the screen.

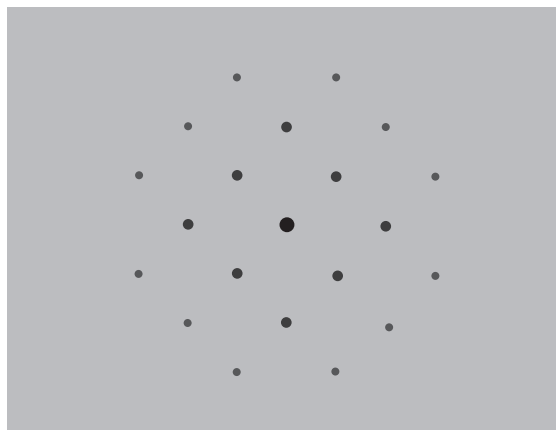

Suggest a reason for the difference in the pattern produced using the £5 note and the pattern produced using the grating.

1

[Turn over

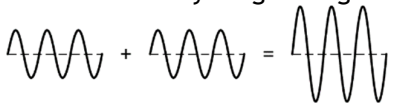

Question			Answer	Max mark	Additional guidance
8.	(a)	(i)	Waves <u>meet</u> in phase. OR Crest <u>meets</u> crest. OR Trough <u>meets</u> trough. OR Path difference = $m\lambda$	1	Accept: peak for crest. Can be shown by diagram eg  Diagram must imply addition of two waves in phase. Do not accept: 'join' or 'merge' alone.
		(ii)	$m\lambda = d \sin \theta$ (1) $3 \times 630 \times 10^{-9} = \frac{1}{250\,000} \sin \theta$ (1) $\theta = 28^\circ$ (1)	3	Accept: 30° , 28.2° , 28.20° Note: $d = 4 \times 10^{-6} \text{ m}$ Alternative substitution: $m\lambda = d \sin \theta$ (1) $3 \times 630 \times 10^{-9} = \frac{1 \times 10^{-3}}{250} \sin \theta$ (1) $\theta = 28^\circ$ (1)
		(iii)	Spots will be further apart. OR Angle θ is greater. (1) Slit separation d of new grating is smaller than the previous grating. (1)	2	Look for correct statement of effect first - if incorrect or missing then 0 marks. Accept: fewer/less spots on the screen. Justification can be done by calculation. If calculation is carried out using $m = 3$, candidate will obtain an invalid answer. This implies fewer/less spots (five) on the screen.
		(iv)	(The waves from the laser have a) constant phase relationship (and have the same frequency, wavelength, and velocity).	1	"In phase" is not sufficient.
	(b)		(Polymer) note has vertical and horizontal or crossed lines/grid/grating.	1	Accept: crosshatch, mesh Accept: diagram to aid description There are vertical and horizontal spots so there are vertical and horizontal lines or a grid of lines.

9. A ray of monochromatic light is incident on a glass prism as shown.

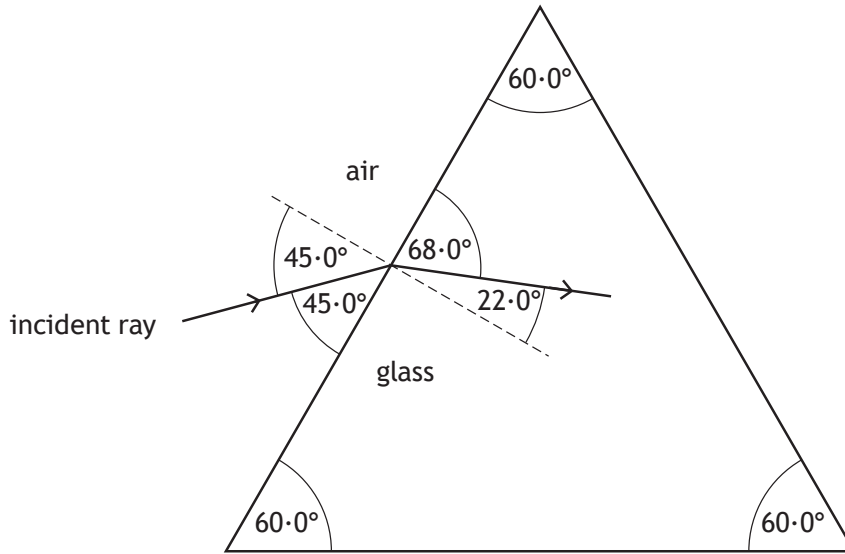

(a) Show that the refractive index of the glass for this ray of light is 1.89. 2
Space for working and answer

(b) (i) State what is meant by the term *critical angle*. 1



9. (b) (continued)

(ii) Calculate the critical angle for this light in the prism.

3

Space for working and answer

(iii) Complete the diagram below to show the path of the ray as it passes through the prism and emerges into the air.

4

Mark on the diagram the values of all relevant angles.

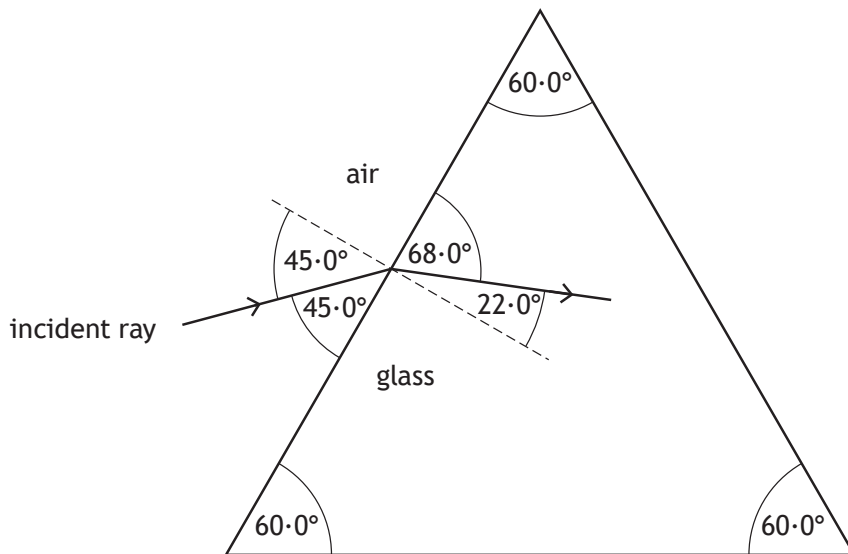

(An additional diagram, if required, can be found on page 45.)

[Turn over



9. (continued)

- (c) A ray of white light is shone through the prism and a spectrum is observed as shown.

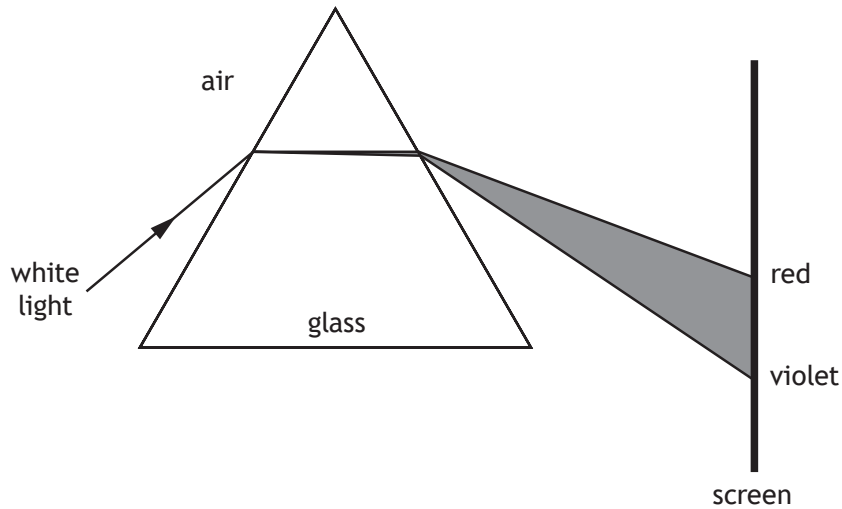

The prism is now replaced with another prism made from a different type of glass with a lower refractive index.

Describe one difference in the spectrum produced by this prism compared to the spectrum produced by the first prism.

1

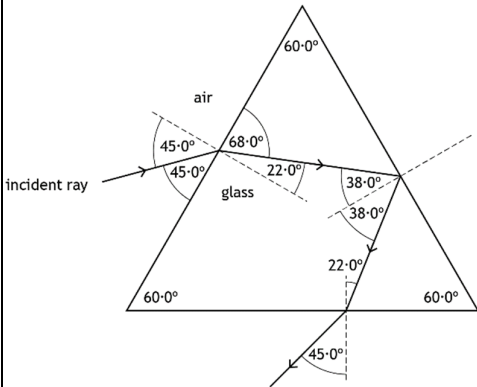

Question			Answer	Max mark	Additional guidance
9.	(a)		$n = \frac{\sin \theta_1}{\sin \theta_2} \quad (1)$ $n = \frac{\sin 45 \cdot 0}{\sin 22 \cdot 0} \quad (1)$ $n = 1.89$	2	<p>“SHOW” question</p> <p>Accept:</p> $\frac{n_2}{n_1} = \frac{\sin \theta_1}{\sin \theta_2} \quad (1)$ $\frac{n_2}{1} = \frac{\sin 45 \cdot 0}{\sin 22 \cdot 0} \quad (1)$ $n = 1.89$
	(b)	(i)	The angle of incidence such that the angle of refraction is 90° .	1	<p>Accept a description of the incident ray as an alternative to the word ‘incidence’.</p> <p>Do not accept: The minimum angle of incidence that causes total internal reflection.</p>
		(ii)	$\sin \theta_c = \frac{1}{n} \quad (1)$ $\sin \theta_c = \frac{1}{1.89} \quad (1)$ $\theta_c = 31.9^\circ \quad (1)$	3	Accept: 32° , 31.94° , 31.945°

Question			Answer	Max mark	Additional guidance
9.	(b)	(iii)	 <p>Total Internal Reflection (1)</p> <p>38° (1)</p> <p>Refraction away from the normal on exit (1)</p> <p>22° and 45° (1)</p>	4	<p>OR consistent with part (ii)</p> <p>If arithmetic error for finding one of the angles - maximum 3 marks.</p> <p>First two marks are independent. To access last two marks TIR must be shown.</p> <p>Reflection at any angle</p> <p>Either incidence or reflection angle labelled.</p> <p>Refraction at any angle</p> <p>Both angles required.</p> <p>Notes: Only penalise missing degree unit once in whole question. Decimal points not required</p> <p>Candidate may calculate exit angle, therefore 45.1° is acceptable</p>
	(c)		<p>Less deviation in spectrum position</p> <p>OR</p> <p>Less dispersion.</p>	1	<p>Accept: Spectrum position higher on screen Smaller spread/width of spectrum Brighter spectrum</p> <p>Do not accept: smaller spectrum alone</p>

10. In a laboratory experiment, light from a hydrogen discharge lamp is used to produce a line emission spectrum. The line spectrum for hydrogen has four lines in the visible region as shown.



- (a) The production of the line spectrum can be explained using the Bohr model of the atom.

State **two** features of the *Bohr model* of the atom.

2

[Turn over



* X 7 5 7 7 6 0 1 3 1 *

10. (continued)

(b) Some of the energy levels of the hydrogen atom are shown.

$$E_4 \text{ ————— } -0.871 \times 10^{-19} \text{ J}$$

$$E_3 \text{ ————— } -1.36 \times 10^{-19} \text{ J}$$

$$E_2 \text{ ————— } -2.42 \times 10^{-19} \text{ J}$$

$$E_1 \text{ ————— } -5.45 \times 10^{-19} \text{ J}$$

$$E_0 \text{ ————— } -21.8 \times 10^{-19} \text{ J}$$

One of the spectral lines is due to electron transitions from E_3 to E_1 .

Determine the frequency of the photon emitted when an electron makes this transition.

3

Space for working and answer



* X 7 5 7 7 6 0 1 3 2 *

10. (continued)

- (c) In the laboratory, a line in the hydrogen spectrum is observed at a wavelength of 656 nm.

When the spectrum of light from a distant galaxy is viewed, this hydrogen line is now observed at a wavelength of 661 nm.

Determine the recessional velocity of the distant galaxy.

5

Space for working and answer

[Turn over



Question		Answer	Max mark	Additional guidance
10.	(a)	<p>A (central) positively charged nucleus.</p> <p>(Negatively charged) electrons in (discrete) energy levels/shells (orbiting the nucleus, not radiating energy.)</p> <p>When an electron moves from one state to another, the energy lost or gained is done so ONLY in very specific amounts of energy.</p> <p>Each line in a spectrum is produced when an electron moves from one energy level/orbit/shell to another.</p>	2	<p>Any two correct answers Independent marks</p> <p>Accept: A clearly labelled diagram</p> <p>A (central) nucleus containing protons (and neutrons).</p> <p>Some indication of quantisation of energy</p> <p>Do not accept: Atom is mainly empty space. Nucleus is small compared to size of the atom. Any statement referring to photons and photon frequency is a consequence, not a feature.</p>
	(b)	$E_2 - E_1 = hf \quad (1)$ $-1.36 \times 10^{-19} - (-5.45 \times 10^{-19}) = 6.63 \times 10^{-34} \times f \quad (1)$ $f = 6.17 \times 10^{14} \text{ Hz} \quad (1)$	3	<p>Accept: 6.2, 6.169, 6.1689</p> <p>Accept: $(\Delta)E = hf$ or $E_3 - E_1 = hf$ for formula mark anywhere</p> <p>Accept: $5.45 \times 10^{-19} - 1.36 \times 10^{-19}$ $= 6.63 \times 10^{-34} \times f$ for substitution mark</p> <p>Note: Correct $\Delta E = 4.09 \times 10^{-19} \text{ (J)}$</p> <p>If $1.36 \times 10^{-19} - 5.45 \times 10^{-19}$ is shown for ΔE, maximum 1 mark for a correct formula.</p>

Question		Answer	Max mark	Additional guidance
10.	(c)	$z = \frac{\lambda_o - \lambda_r}{\lambda_r}$	(1)	5 Accept: 2.3, 2.287, 2.2866 $z = \frac{\lambda_o - \lambda_r}{\lambda_r}$ anywhere, 1 mark $z = \frac{v}{c}$ anywhere, 1 mark Substitution of 3.00×10^8 (1) Alternative method: $\frac{v}{c} = \frac{\lambda_o - \lambda_r}{\lambda_r}$ $\frac{v}{3.00 \times 10^8} = \frac{661 - 656}{656}$ $v = 2.29 \times 10^6 \text{ m s}^{-1}$ Equating formula, (2) Substitution of wavelengths, (1) Substitution of 3.00×10^8 (1) Final answer (1)
		$z = \frac{661 - 656}{656}$	(1)	
		$(z = 7.62195122 \times 10^{-3})$		
		$z = \frac{v}{c}$	(1)	
		$7.62195122 \times 10^{-3} = \frac{v}{3.00 \times 10^8}$	(1)	
		$v = 2.29 \times 10^6 \text{ m s}^{-1}$	(1)	

11. A student constructs a battery using a potato, a strip of copper and a strip of magnesium.

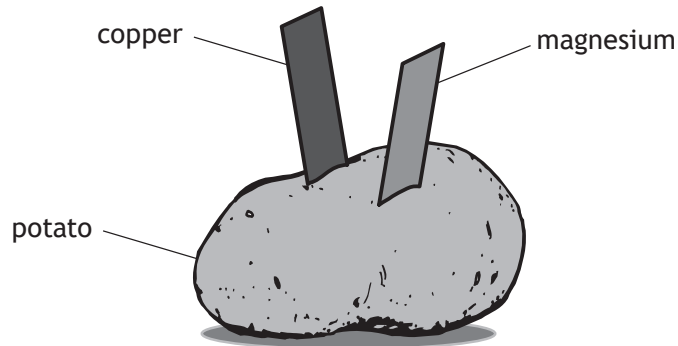

The student then sets up the following circuit with the potato battery connected to a variable resistor R , in order that the electromotive force (e.m.f.) and internal resistance of the battery may be determined.

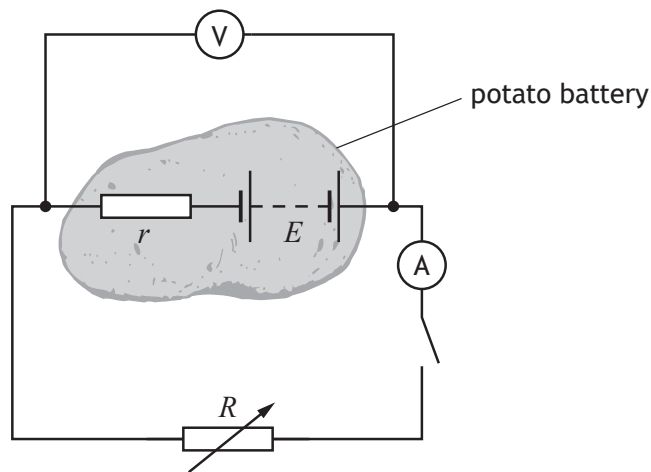

- (a) State what is meant by the term *electromotive force (e.m.f.)*.

1



11. (continued)

MARKS

DO NOT
WRITE IN
THIS
MARGIN

- (b) The student uses readings of current I and terminal potential difference V from this circuit to produce the graph shown.

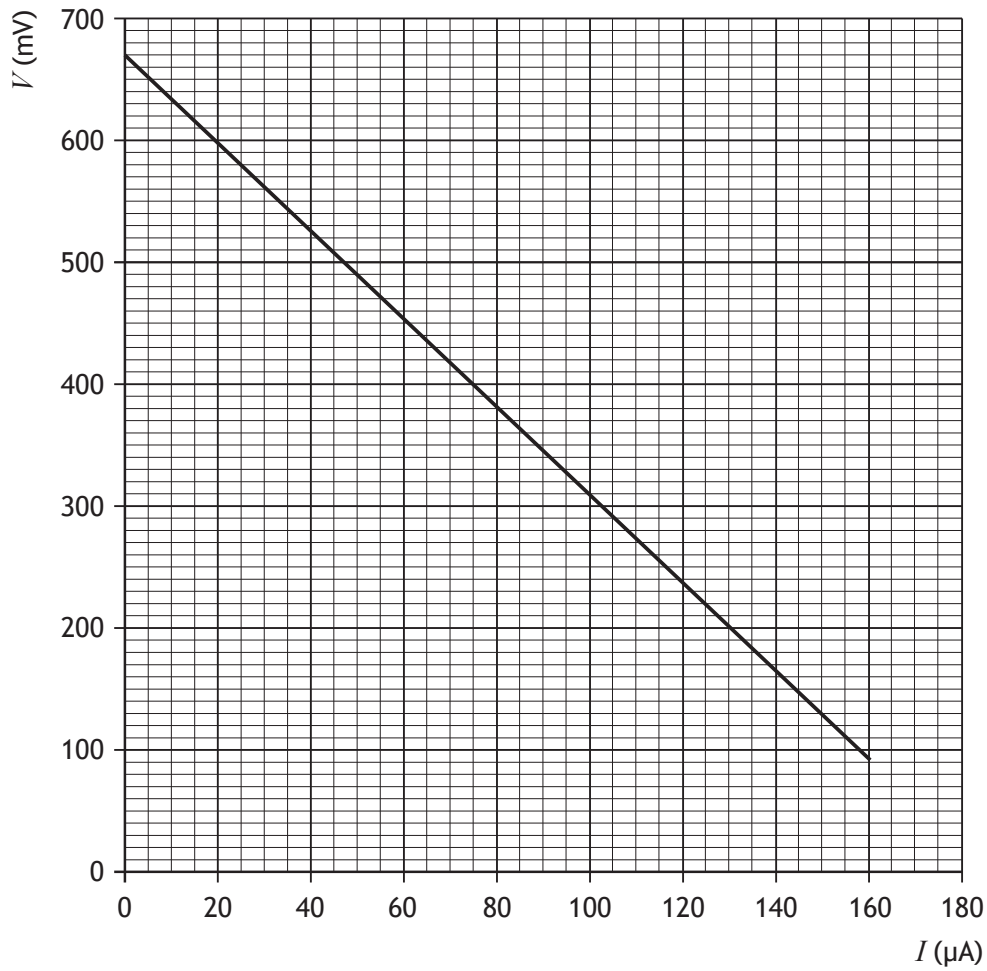

Determine the internal resistance of the potato battery.

3

Space for working and answer

[Turn over



11. (continued)

(c) The student connects a red LED and a blue LED, in turn, to the battery.

The LEDs are forward biased when connected.

The student observes that the battery will operate the red LED but not the blue LED.

The diagram represents the band structure of the blue LED.

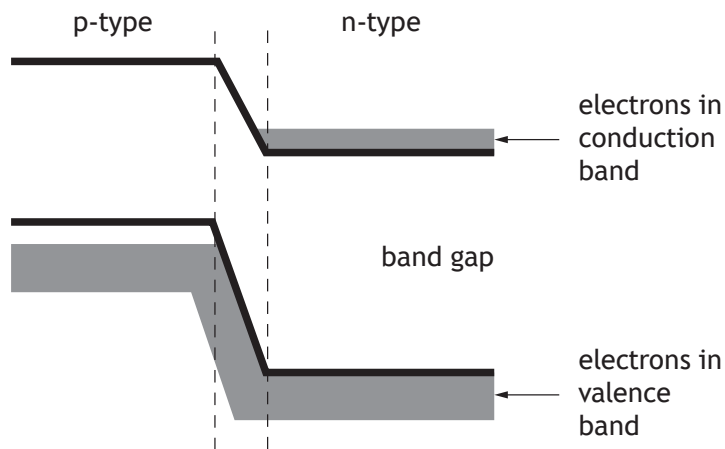

LEDs emit light when electrons fall from the conduction band into the valence band of the p-type semiconductor.

Explain, using **band theory**, why the blue LED will not operate with this battery.

1



Question		Answer	Max mark	Additional guidance
11.	(a)	The number of joules/energy gained by/supplied to 1 coulomb (of charge passing through the cell).	1	Accept unit charge for 1 coulomb.
	(b)	$\text{gradient} = \frac{(290 \times 10^{-3} - 470 \times 10^{-3})}{(105 \times 10^{-6} - 55 \times 10^{-6})} \quad (1)$ $\text{gradient} = -3600 \quad (1)$ (gradient = -r) $r = 3600 \, \Omega \quad (1)$	3	Accept: 4000 Gradient = r is wrong physics, award 0 marks. subs into gradient formula (1) calculating gradient (1) Alternative method: $E = V + Ir \quad (1)$ $670 \times 10^{-3} = 400 \times 10^{-3} + 75 \times 10^{-6} r \quad (1)$ $r = 3600 \, \Omega \quad (1)$
	(c)	The electrons do not gain enough energy to move into/towards the conduction band of the p-type.	1	Electrons in conduction band (of the n-type) do not gain enough energy to move into/towards the p-type.

12. A student carries out a series of experiments to investigate alternating current.

(a) A signal generator is connected to an oscilloscope and a circuit as shown.

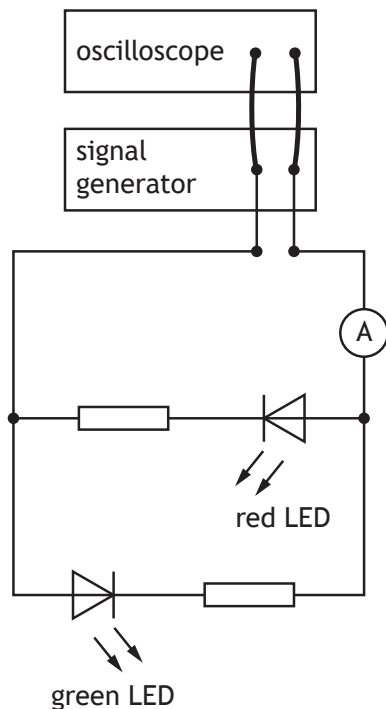

The output of the signal generator is displayed on the oscilloscope.

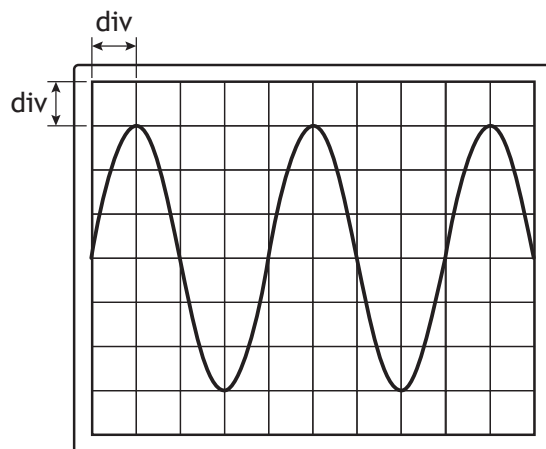

The Y-gain setting on the oscilloscope is 1.0V/div.

The timebase setting on the oscilloscope is 0.5 s/div.



MARKS
DO NOT
WRITE IN
THIS
MARGIN

12. (a) (continued)

(i) Determine the peak voltage of the output of the signal generator. **1**
Space for working and answer

(ii) Determine the frequency of the output of the signal generator. **3**
Space for working and answer

(iii) The student observes that the red LED is only lit when the ammeter gives a positive reading and the green LED is only lit when the ammeter gives a negative reading. **2**
Explain these observations.



12. (continued)

- (b) The signal generator is now connected in a circuit as shown.
The settings on the signal generator are unchanged.
The signal generator has negligible internal resistance.

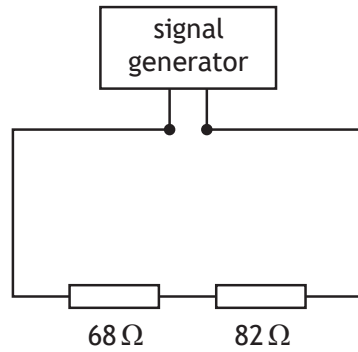

Determine the r.m.s. voltage across the 82 Ω resistor.

5

Space for working and answer



Question			Answer	Max mark	Additional guidance
12.	(a)	(i)	$(3 \times 1.0 =) 3.0 \text{ V}$ (1)	1	Accept: 3, 3.00, 3.000
		(ii)	$f = \frac{1}{T}$ (1) $f = \frac{1}{2}$ (1) $f = 0.5 \text{ Hz}$ (1)	3	Accept: 0.50, 0.500
		(iii)	The LEDs will light when they are forward biased. (1) The change in polarity of voltage changes the biasing. (1)	2	Independent marks LEDs will only conduct in one direction (1) Identifying current/voltage has changed direction (1) Do not accept 'different direction' alone. One LED conducts during one half of the cycle the other LED conducts during the other half of the cycle.
	(b)		$V_2 = \left(\frac{R_2}{R_1 + R_2} \right) V_s$ (1) $V_2 = \left(\frac{82}{68 + 82} \right) \times 3.0$ (1) $V_2 = 1.64 \text{ (V)}$ $V_{peak} = \sqrt{2} V_{rms}$ (1) $1.64 = \sqrt{2} V_{rms}$ (1) $V_{rms} = 1.2 \text{ V}$ (1)	5	OR consistent with (a)(i) Accept: 1, 1.16, 1.160 Alternative Methods: $V_{peak} = \sqrt{2} V_{rms}$ (1) $3.0 = \sqrt{2} V_{rms}$ (1) $V_{rms} = 2.12132034 \text{ (V)}$ $V_2 = \left(\frac{R_2}{R_1 + R_2} \right) V_s$ (1) $V_2 = \left(\frac{82}{68 + 82} \right) \times 2.12132034$ (1) $V_2 = 1.2 \text{ V}$ (1)

Question		Answer	Max mark	Additional guidance
12.	(b)	continued		<p>OR</p> $V_{peak} = \sqrt{2}V_{rms} \quad (1)$ $3 \cdot 0 = \sqrt{2}V_{rms} \quad (1)$ $V_{rms} = 2 \cdot 12132034 \text{ (V)}$ $V = IR$ $2 \cdot 12132034 = I \times (68 + 82)$ $I = 0 \cdot 0141421356 \text{ (A)}$ $V = IR$ $V = 0 \cdot 0141421356 \times 82$ $V = 1 \cdot 2 \text{ V}$ $V = IR \text{ twice} \quad (1)$ <p>Both substitutions into $V = IR$ (1)</p> <p>Final answer (1)</p> <p>OR</p> $V = IR$ $3 \cdot 0 = I \times (68 + 82)$ $I = 0 \cdot 02 \text{ (A)}$ $V = IR$ $V = 0 \cdot 02 \times 82$ $V = 1 \cdot 64 \text{ (V)}$ $V_{peak} = \sqrt{2}V_{rms} \quad (1)$ $1 \cdot 64 = \sqrt{2}V_{rms} \quad (1)$ $V_{rms} = 1 \cdot 2 \text{ V}$ $V = IR \text{ twice} \quad (1)$ <p>Both substitutions into $V = IR$ (1)</p> <p>Final answer (1)</p>

13. A student sets up an experiment to investigate the pressure due to a liquid as shown.

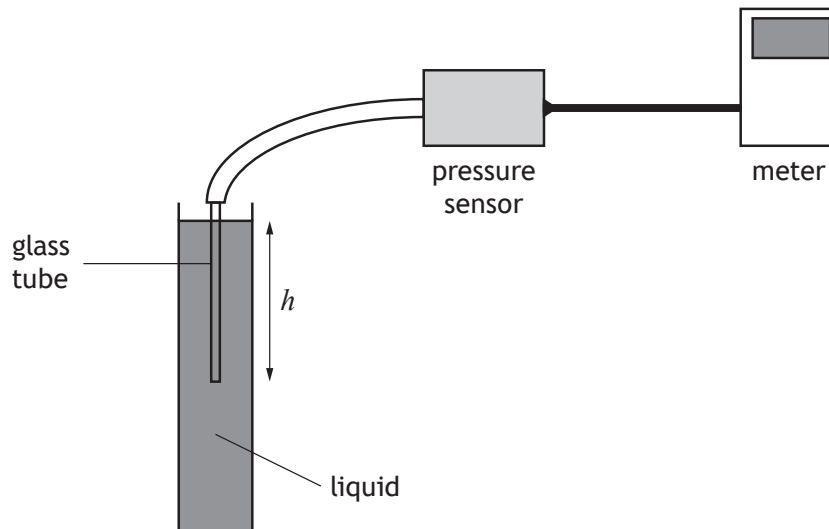

The pressure due to a liquid is given by the relationship

$$p = \rho gh$$

where p is the pressure due to the liquid in pascals (Pa),

g is the gravitational field strength in N kg^{-1} ,

ρ is the density of the liquid in kg m^{-3} ,

and h is the depth in the liquid in m.

- (a) The student initially carries out the investigation using water.

The density of water is $1.00 \times 10^3 \text{ kg m}^{-3}$.

Calculate the pressure due to the water at a depth of 0.35 m.

2

Space for working and answer



* X 7 5 7 7 6 0 1 4 1 *

13. (continued)

- (b) The student repeats the experiment with a different liquid.

The pressure meter is set to zero before the glass tube is lowered into the liquid.

The student takes measurements of the pressure at various depths below the surface of the liquid.

The student records the following information.

Depth, h (m)	Pressure, p (kPa)
0.10	1.2
0.20	2.5
0.30	3.6
0.40	4.9
0.50	6.2

- (i) Using the square-ruled paper on *page 43*, draw a graph of p against h . 3
 (Additional graph paper, if required, can be found on *page 44*.)
- (ii) Calculate the gradient of your graph. 2
Space for working and answer
- (iii) Determine the density of this liquid. 2
Space for working and answer

[END OF QUESTION PAPER]



Question		Answer	Max mark	Additional guidance	
13.	(a)	$p = 1.00 \times 10^3 \times 9.8 \times 0.35$ $p = 3.4 \times 10^3 \text{ Pa}$	(1) (1)	2 Accept: 3, 3.43, 3.430	
	(b)	(i)	Suitable scales with labels on axes (quantity and units) (1) Correct plotting of points (1) Appropriate line of best fit (1)	3 Allow for axes starting at zero or broken axes or at an appropriate value. Accuracy of plotting should be easily checkable with the scale chosen. If the origin is shown the scale must either be continuous or the axis must be 'broken'. Otherwise maximum 2 marks. Do not penalise if the candidate plots h against p .	
		(ii)	$m = \frac{y_2 - y_1}{x_2 - x_1}$ $m = \frac{4.9 \times 10^3 - 1.2 \times 10^3}{0.40 - 0.10}$ $= 12\,000 \text{ (Pa m}^{-1}\text{)}$	(1) (1)	2 Must be consistent with graph drawn for (b)(i). Candidates are asked to calculate the gradient of their graph . Tolerance required depending upon best fit line drawn by the candidate. Accept: $m = \frac{y_2 - y_1}{x_2 - x_1}$ $m = \frac{4.9 - 1.2}{0.40 - 0.10} \quad (1)$ $= 12 \text{ (kPa m}^{-1}\text{)} \quad (1)$

Question		Answer	Max mark	Additional guidance
13.	(iii)	<p><i>(gradient = ρg)</i></p> <p>$12\ 000 = \rho g$ (1)</p> <p>$\rho = 1.2 \times 10^3 \text{ kg m}^{-3}$ (1)</p>	2	<p>OR consistent with (b)(ii)</p> <p>If $m = 12$ in (b)(ii)</p> <p>$12 = \rho g$ (1)</p> <p>$\rho = 1.2 \times 10^3 \text{ kg m}^{-3}$ (1)</p> <p>If candidate arrives at this answer then they have taken into consideration the prefix (kPa).</p> <p>If the candidate has drawn a straight line through the origin (tolerance within ± 1 full division), then any point on the line, within $\pm \frac{1}{2}$ division tolerance, can be used to calculate the density using $p = \rho gh$.</p> <p>If the candidate has used a point on their line and uses continuous scales from zero, but has not extended their line back through the origin, then use the ruler tool to confirm that their line passes through the origin within tolerance.</p> <p>If the line drawn (or extrapolated line 'created' on Assessor) does NOT pass through the origin within ± 1 full division tolerance, the gradient of the line must be used and not one single point selected, otherwise 0 marks.</p>

Question			Answer	Max mark	Additional guidance
13.		(iii)	continued		<p>If candidate has chosen an appropriate point on their line, 1 mark for correct substitution 1 mark for final answer.</p> <p>If the candidate uses a broken scale on either axis, or does not start their scale at zero, they <u>must</u> use the gradient in their calculation of ρ, otherwise 0 marks.</p> <p>If candidate has plotted h against p, the formula becomes</p> $\rho g = \frac{1}{\text{gradient}},$ <p>otherwise 0 marks for the 'gradient' method. The method by selecting a valid point is can still be used, and the criteria above apply.</p>

[END OF MARKING INSTRUCTIONS]



National
Qualifications
SPECIMEN ONLY

S857/76/12

**Physics
Paper 1 — Multiple choice**

Date — Not applicable

Duration — 45 minutes

Total marks — 25

Attempt ALL questions.

You may use a calculator.

Instructions for the completion of Paper 1 are given on *page 02* of your answer booklet S857/76/02.

Record your answers on the answer grid on *page 03* of your answer booklet.

Reference may be made to the data sheet on *page 02* of this question paper and to the relationships sheet S857/76/22.

Space for rough work is provided at the end of this booklet.

Before leaving the examination room you must give your answer booklet to the Invigilator; if you do not, you may lose all the marks for this paper.



DATA SHEET

COMMON PHYSICAL QUANTITIES

Quantity	Symbol	Value	Quantity	Symbol	Value
Speed of light in vacuum	c	$3.00 \times 10^8 \text{ m s}^{-1}$	Planck's constant	h	$6.63 \times 10^{-34} \text{ J s}$
Magnitude of the charge on an electron	e	$1.60 \times 10^{-19} \text{ C}$	Mass of electron	m_e	$9.11 \times 10^{-31} \text{ kg}$
Universal Constant of Gravitation	G	$6.67 \times 10^{-11} \text{ m}^3 \text{ kg}^{-1} \text{ s}^{-2}$	Mass of neutron	m_n	$1.675 \times 10^{-27} \text{ kg}$
Gravitational acceleration on Earth	g	9.8 m s^{-2}	Mass of proton	m_p	$1.673 \times 10^{-27} \text{ kg}$
Hubble's constant	H_0	$2.3 \times 10^{-18} \text{ s}^{-1}$			

REFRACTIVE INDICES

The refractive indices refer to sodium light of wavelength 589 nm and to substances at a temperature of 273 K.

Substance	Refractive index	Substance	Refractive index
Diamond	2.42	Water	1.33
Crown glass	1.50	Air	1.00

SPECTRAL LINES

Element	Wavelength/nm	Colour	Element	Wavelength/nm	Colour
Hydrogen	656	Red	Cadmium	644	Red
	486	Blue-green		509	Green
	434	Blue-violet		480	Blue
	410	Violet	Lasers		
	397	Ultraviolet	<i>Element</i>	<i>Wavelength/nm</i>	<i>Colour</i>
	389	Ultraviolet	Carbon dioxide	9550 } 10 590 }	Infrared
Sodium	589	Yellow	Helium-neon	633	Red

PROPERTIES OF SELECTED MATERIALS

Substance	Density/kg m ⁻³	Melting point/K	Boiling point/K
Aluminium	2.70×10^3	933	2623
Copper	8.96×10^3	1357	2853
Ice	9.20×10^2	273
Sea Water	1.02×10^3	264	377
Water	1.00×10^3	273	373
Air	1.29
Hydrogen	9.0×10^{-2}	14	20

The gas densities refer to a temperature of 273 K and a pressure of $1.01 \times 10^5 \text{ Pa}$.

Total marks — 25
Attempt ALL questions

1. The following velocity-time graph represents the vertical motion of a ball.

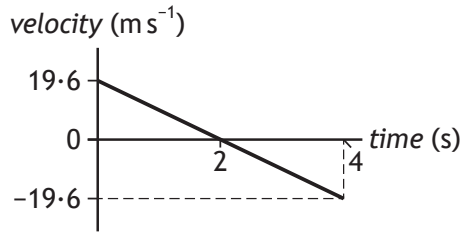

Which of the following acceleration-time graphs represents the same motion?

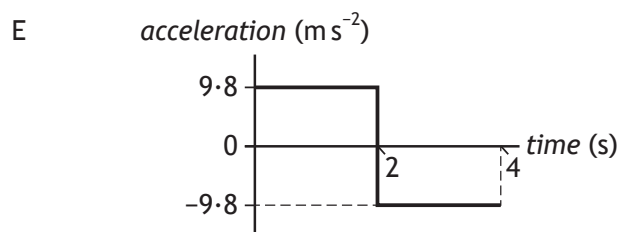
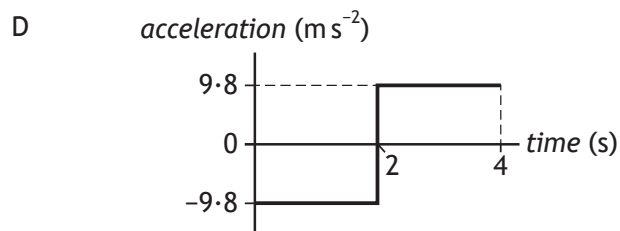
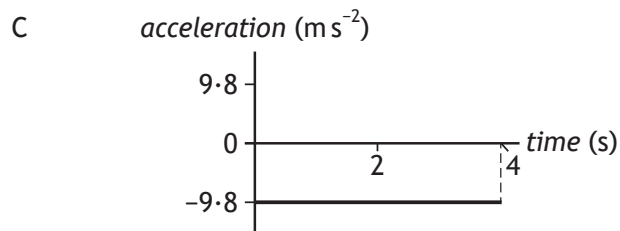
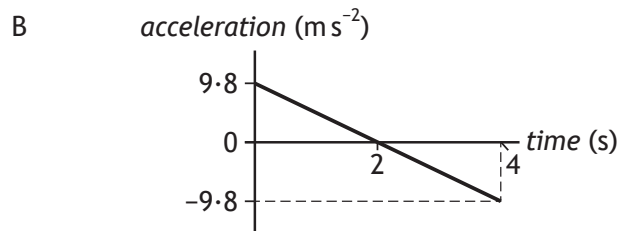
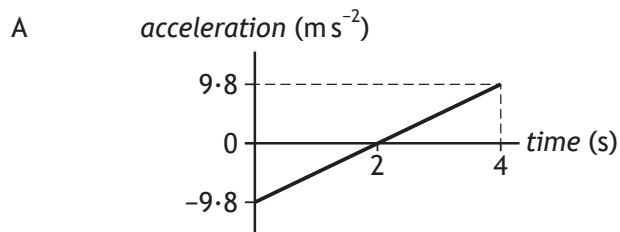

2. A train accelerates uniformly from 5.0 m s^{-1} to 12.0 m s^{-1} while travelling a distance of 119 m along a straight track.

The acceleration of the train is

- A 0.50 m s^{-2}
 - B 0.70 m s^{-2}
 - C 1.2 m s^{-2}
 - D 7.0 m s^{-2}
 - E 14 m s^{-2} .
3. Two blocks are linked by a newton balance of negligible mass. The blocks are placed on a level, frictionless surface. A force of 18.0 N is applied to the blocks as shown.



The reading on the newton balance is

- A 3.6 N
- B 7.2 N
- C 9.0 N
- D 10.8 N
- E 18.0 N.

4. A block of wood slides with a constant velocity down a slope. The slope makes an angle of 30.0° with the horizontal as shown. The mass of the block is 2.0 kg .

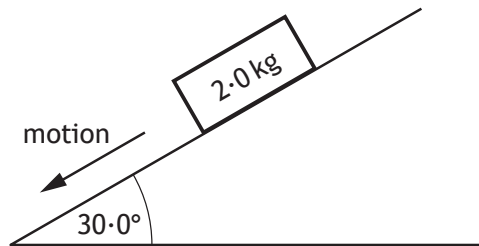

The magnitude of the force of friction acting on the block is

- A 1.0 N
 - B 1.7 N
 - C 9.8 N
 - D 17 N
 - E 19.6 N .
5. The diagram shows the masses and velocities of two trolleys just before they collide on a level bench.



After the collision, the trolleys move along the bench joined together.

The kinetic energy lost in this collision is

- A 0 J
- B 6.0 J
- C 12 J
- D 18 J
- E 24 J .

[Turn over

6. The graph shows the force that acts on an object over a time interval of 8.0 seconds.

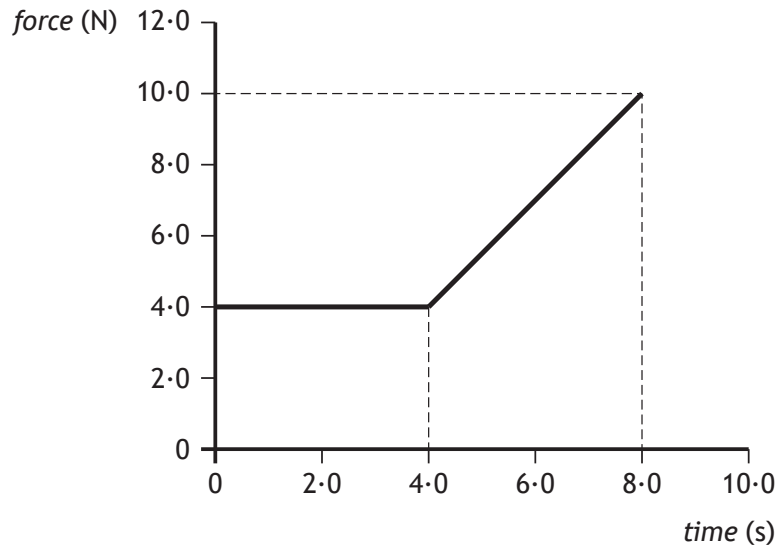

The momentum gained by the object during the 8.0 seconds is

- A 12 kg m s^{-1}
 - B 32 kg m s^{-1}
 - C 44 kg m s^{-1}
 - D 52 kg m s^{-1}
 - E 80 kg m s^{-1} .
7. A javelin is thrown at an angle of 60.0° to the horizontal with a speed of 20.0 m s^{-1} .

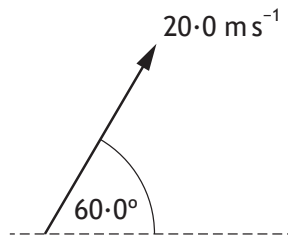

The javelin is in flight for 3.50 s.

The effects of air resistance can be ignored.

The horizontal distance travelled by the javelin is

- A 15.3 m
- B 35.0 m
- C 60.6 m
- D 70.0 m
- E 121 m.

8. Two small asteroids are 12 m apart.

The masses of the asteroids are 2.0×10^3 kg and 0.050×10^3 kg.

The gravitational force acting between the asteroids is

- A 1.2×10^{-9} N
- B 4.6×10^{-8} N
- C 5.6×10^{-7} N
- D 1.9×10^{-6} N
- E 6.8×10^3 N.

9. A spaceship on a launch pad is measured to have a length L .

This spaceship has a speed of 2.5×10^8 m s⁻¹ as it passes a planet.

Which row in the table describes the length of the spaceship as measured by the pilot in the spaceship and an observer on the planet?

	<i>Length measured by pilot in the spaceship</i>	<i>Length measured by observer on the planet</i>
A	L	greater than L
B	L	L
C	L	less than L
D	greater than L	L
E	less than L	less than L

[Turn over

10. The siren on an ambulance is emitting sound with a constant frequency of 900 Hz. The ambulance is travelling at a constant speed of 25 m s^{-1} as it approaches and passes a stationary observer. The speed of sound in air is 340 m s^{-1} .

Which row in the table shows the frequency of the sound heard by the observer as the ambulance approaches and as it moves away from the observer?

	<i>Frequency as ambulance approaches (Hz)</i>	<i>Frequency as ambulance moves away (Hz)</i>
A	900	838
B	971	838
C	838	900
D	971	900
E	838	971

11. Cosmic microwave background radiation and Olbers' paradox provide evidence for

- A the photoelectric effect
- B the Bohr model of the atom
- C the theory of special relativity
- D the Big Bang theory
- E Newton's Law of Universal Gravitation.

12. A student makes the following statements about particles in electric fields.

- I A neutron experiences a force in an electric field.
- II When an alpha particle is moved in an electric field work is done.
- III An electric field applied to a conductor causes the free electrons in the conductor to move.

Which of the statements is/are correct?

- A II only
- B III only
- C I and II only
- D II and III only
- E I, II and III

13. The electric field patterns around charged particles Q, R and S are shown.

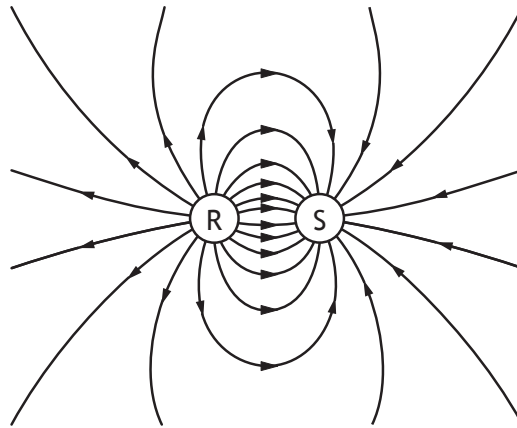
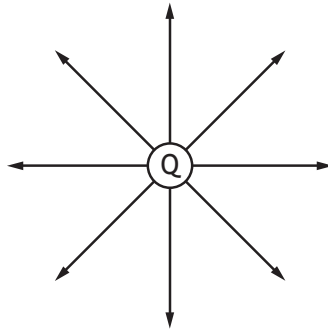

Which row in the table shows the charges on particles Q, R and S?

	<i>Charge on Q</i>	<i>Charge on R</i>	<i>Charge on S</i>
A	negative	negative	positive
B	positive	positive	negative
C	negative	positive	negative
D	negative	negative	negative
E	positive	positive	positive

[Turn over

14. A student makes the following statements about an electron.

- I An electron is a boson.
- II An electron is a lepton.
- III An electron is a fermion.

Which of these statements is/are correct?

- A I only
- B II only
- C III only
- D I and II only
- E II and III only

15. The last two changes in a radioactive decay series are shown below.

A Bismuth nucleus emits a beta particle and its product, a Polonium nucleus, emits an alpha particle.



Which numbers are represented by P, Q, R and S?

	<i>P</i>	<i>Q</i>	<i>R</i>	<i>S</i>
A	210	83	208	81
B	210	83	210	84
C	211	85	207	86
D	212	83	212	84
E	212	85	212	84

16. Light from a point source is incident on a screen. The screen is 3.0 m from the source. The irradiance at the screen is 8.0 W m^{-2} .
The light source is now moved to a distance of 12 m from the screen.
The irradiance at the screen is now

- A 0.50 W m^{-2}
- B 2.0 W m^{-2}
- C 4.0 W m^{-2}
- D 6.0 W m^{-2}
- E 8.0 W m^{-2} .

17. S_1 and S_2 are sources of coherent waves.
An interference pattern is obtained between X and Y.

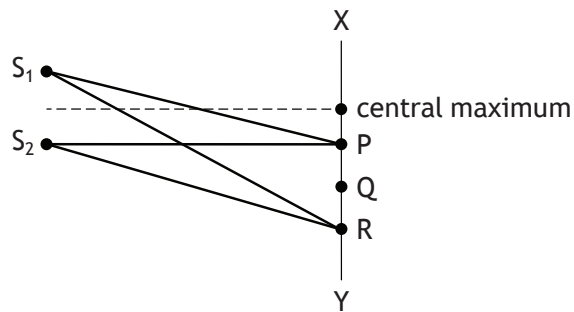

The first order maximum occurs at P, where $S_1P = 200 \text{ mm}$ and $S_2P = 180 \text{ mm}$.
For the third order maximum, at R, the path difference ($S_1R - S_2R$) is

- A 20 mm
- B 30 mm
- C 40 mm
- D 50 mm
- E 60 mm.

[Turn over

18. In an atom, a photon is emitted when an electron makes a transition from a higher energy level to a lower energy level as shown.

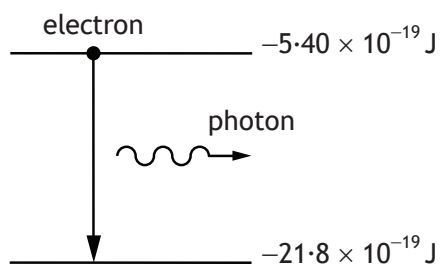

The wavelength of the radiation emitted due to an electron transition between the two energy levels shown is

- A $7.31 \times 10^{-8} \text{ m}$
 - B $9.12 \times 10^{-8} \text{ m}$
 - C $1.21 \times 10^{-7} \text{ m}$
 - D $8.23 \times 10^6 \text{ m}$
 - E $2.47 \times 10^{15} \text{ m}$.
19. A ray of red light travels from air into water.
Which row in the table describes the change, if any, in speed and frequency of a ray of red light as it travels from air into water?

	<i>Speed</i>	<i>Frequency</i>
A	stays constant	decreases
B	increases	increases
C	increases	stays constant
D	decreases	stays constant
E	decreases	decreases

20. The rms voltage of the mains supply is 230 V.
The approximate value of the peak voltage is

- A 115 V
- B 163 V
- C 325 V
- D 460 V
- E 651 V.

21. An oscilloscope is connected to the output terminals of a signal generator.
The trace displayed on the screen is shown.

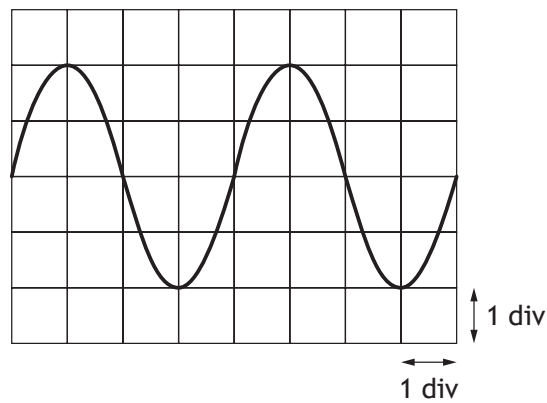

The timebase of the oscilloscope is set at 30 ms/div.

The frequency of the output signal from the signal generator is

- A 4.2×10^{-3} Hz
- B 8.3×10^{-3} Hz
- C 0.12 Hz
- D 4.2 Hz
- E 8.3 Hz.

[Turn over

22. In the diagrams below, each resistor has the same resistance.

Which combination has the least value of the effective resistance between the terminals X and Y?

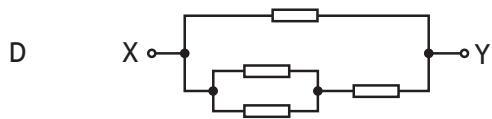
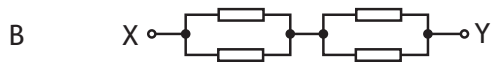
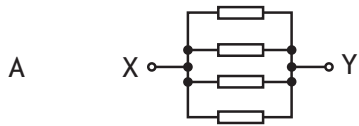

23. Four resistors each of resistance $20\ \Omega$ are connected to a 60V supply of negligible internal resistance as shown.

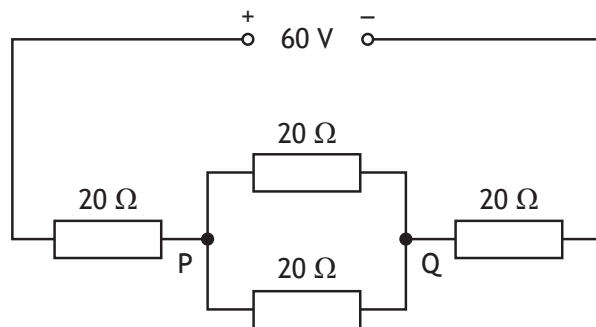

The potential difference across PQ is

- A 12V
- B 15V
- C 20V
- D 24V
- E 30V.

24. The EMF of a battery is
- A the total energy supplied by the battery
 - B the voltage lost due to the internal resistance of the battery
 - C the total charge that passes through the battery
 - D the number of coulombs of charge passing through the battery per second
 - E the energy supplied to each coulomb of charge passing through the battery.
25. A student carries out three experiments to investigate the charging of a capacitor using a DC supply.

The graphs obtained from the experiments are shown.

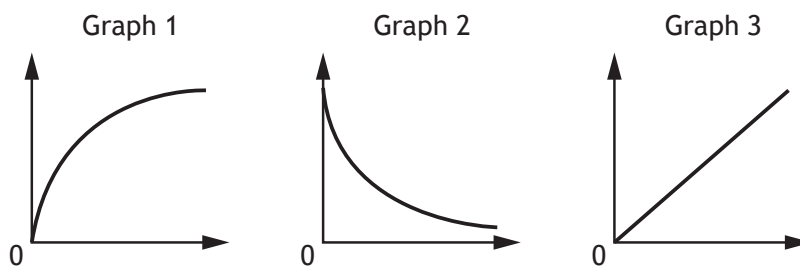

The axes of the graphs have not been labelled.

Which row in the table shows the labels for the axes of the graphs?

	<i>Graph 1</i>	<i>Graph 2</i>	<i>Graph 3</i>
A	voltage and time	charge and voltage	current and time
B	current and time	voltage and time	charge and voltage
C	current and time	charge and voltage	voltage and time
D	voltage and time	current and time	charge and voltage
E	charge and voltage	current and time	voltage and time

[END OF SPECIMEN QUESTION PAPER]

Marking instructions for each question

Question	Answer	Max mark
1.	C	1
2.	A	1
3.	B	1
4.	C	1
5.	C	1
6.	C	1
7.	B	1
8.	B	1
9.	C	1
10.	B	1
11.	D	1
12.	D	1
13.	B	1
14.	E	1
15.	D	1
16.	A	1
17.	E	1
18.	C	1
19.	D	1
20.	C	1
21.	E	1
22.	A	1
23.	A	1
24.	E	1
25.	D	1

[END OF SPECIMEN MARKING INSTRUCTIONS]



FOR OFFICIAL USE

--	--	--	--	--	--

National
Qualifications
SPECIMEN ONLY

Mark

--

S857/76/01

**Physics
Paper 2**

Date — Not applicable

Duration — 2 hours 15 minutes



Fill in these boxes and read what is printed below.

Full name of centre

--

Town

--

Forename(s)

--

Surname

--

Number of seat

--

Date of birth

Day

--	--

Month

--	--

Year

--	--

Scottish candidate number

--	--	--	--	--	--	--	--	--	--

Total marks — 130

Attempt ALL questions.

You may use a calculator.

Reference may be made to the data sheet on *page 02* of this booklet and to the relationships sheet S857/76/11.

Care should be taken to give an appropriate number of significant figures in the final answers to calculations.

Write your answers clearly in the spaces provided in this booklet. Additional space for answers and rough work is provided at the end of this booklet. If you use this space you must clearly identify the question number you are attempting. Any rough work must be written in this booklet. Score through your rough work when you have written your final copy.

Use **blue** or **black** ink.

Before leaving the examination room you must give this booklet to the invigilator; if you do not, you may lose all the marks for this paper.



DATA SHEET

COMMON PHYSICAL QUANTITIES

Quantity	Symbol	Value	Quantity	Symbol	Value
Speed of light in vacuum	c	$3.00 \times 10^8 \text{ m s}^{-1}$	Planck's constant	h	$6.63 \times 10^{-34} \text{ J s}$
Magnitude of the charge on an electron	e	$1.60 \times 10^{-19} \text{ C}$	Mass of electron	m_e	$9.11 \times 10^{-31} \text{ kg}$
Universal Constant of Gravitation	G	$6.67 \times 10^{-11} \text{ m}^3 \text{ kg}^{-1} \text{ s}^{-2}$	Mass of neutron	m_n	$1.675 \times 10^{-27} \text{ kg}$
Gravitational acceleration on Earth	g	9.8 m s^{-2}	Mass of proton	m_p	$1.673 \times 10^{-27} \text{ kg}$
Hubble's constant	H_0	$2.3 \times 10^{-18} \text{ s}^{-1}$			

REFRACTIVE INDICES

The refractive indices refer to sodium light of wavelength 589 nm and to substances at a temperature of 273 K.

Substance	Refractive index	Substance	Refractive index
Diamond	2.42	Water	1.33
Crown glass	1.50	Air	1.00

SPECTRAL LINES

Element	Wavelength/nm	Colour	Element	Wavelength/nm	Colour
Hydrogen	656	Red	Cadmium	644	Red
	486	Blue-green		509	Green
	434	Blue-violet		480	Blue
	410	Violet	Lasers		
	397	Ultraviolet	<i>Element</i>	<i>Wavelength/nm</i>	<i>Colour</i>
	389	Ultraviolet	Carbon dioxide	9550 } 10590 }	Infrared
Sodium	589	Yellow	Helium-neon	633	Red

PROPERTIES OF SELECTED MATERIALS

Substance	Density/kg m ⁻³	Melting point/K	Boiling point/K
Aluminium	2.70×10^3	933	2623
Copper	8.96×10^3	1357	2853
Ice	9.20×10^2	273
Sea Water	1.02×10^3	264	377
Water	1.00×10^3	273	373
Air	1.29
Hydrogen	9.0×10^{-2}	14	20

The gas densities refer to a temperature of 273 K and a pressure of $1.01 \times 10^5 \text{ Pa}$.



Total marks — 130
Attempt ALL questions

MARKS
DO NOT
WRITE IN
THIS
MARGIN

1. A car is travelling at a constant speed of 15.0 m s^{-1} along a straight, level road. It passes a motorcycle, which is stationary at the roadside.

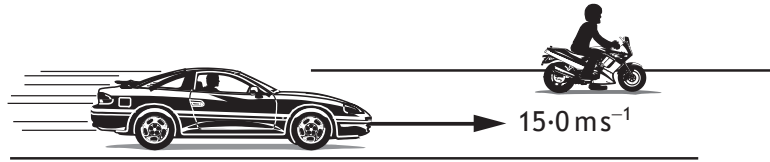

At the instant the car passes, the motorcycle starts to move in the same direction as the car.

The graph shows the motion of each vehicle from the instant the car passes the motorcycle.

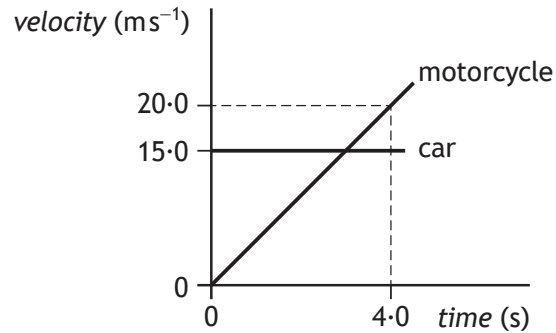

- (a) Calculate the initial acceleration of the motorcycle. 3
Space for working and answer
- (b) Determine the distance between the car and motorcycle at 4.0 s. 4
Space for working and answer



1. (continued)

MARKS

DO NOT
WRITE IN
THIS
MARGIN

(c) The total mass of the motorcycle and rider is 290 kg. At a time of 2.0 s the driving force on the motorcycle is 1800 N.

(i) Determine the frictional force acting on the motorcycle at this time.

4

Space for working and answer

(ii) Explain why the driving force must be increased with time to maintain a constant acceleration.

2



* S 8 5 7 7 6 0 1 0 4 *

1. (continued)

- (d) The driving force on the motorcycle reaches its maximum value at 5.0 s and then remains constant.

The velocity-time graph for the motorcycle during the first 4.0 s is shown below.

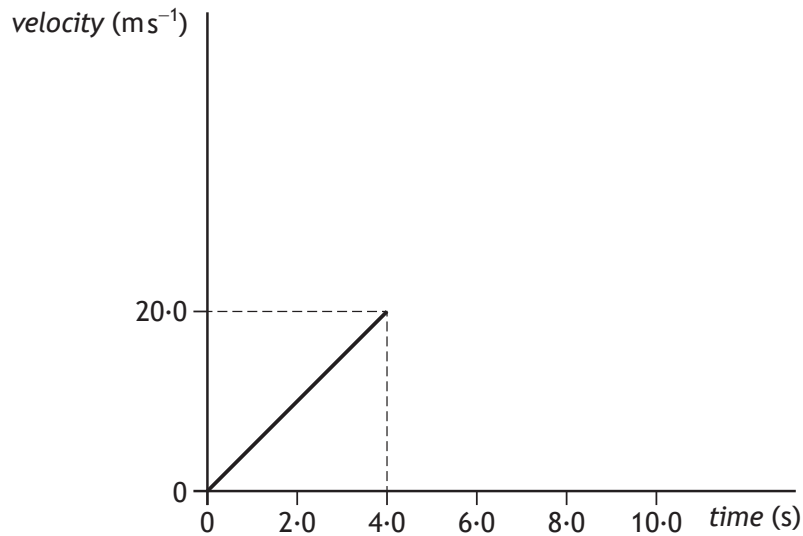

Extend the graph to show how the velocity of the motorcycle varies between 4.0 s and 10.0 s.

Additional numerical values on the velocity axis are **not** required.

(An additional graph, if required, can be found on *page 42*.)

1

[Turn over

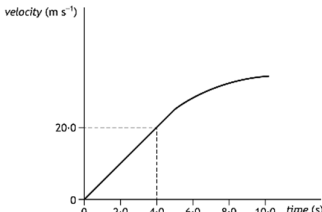

Marking instructions for each question

Question		Expected response	Max mark	Additional guidance
1.	(a)	$v = u + at$ (1) $20.0 = 0 + a \times 4.0$ (1) $a = 5.0 \text{ m s}^{-2}$ (1)	3	Accept 5, 5.00, 5.000
	(b)	motorcycle $s = \text{area under graph}$ (1) $s = \frac{1}{2} \times 4.0 \times 20.0$ (1) car $s = \text{area under graph}$ $s = 4.0 \times 15.0$ (1) $s_{\text{between}} = (4.0 \times 15.0) - (\frac{1}{2} \times 4.0 \times 20.0)$ $s_{\text{between}} = 20 \text{ m}$ (1)	4	Accept 20.0, 20.00 Alternative method motorcycle $s = ut + \frac{1}{2}at^2$ $s = \frac{1}{2} \times 5.0 \times 4.0^2$ car $d = \bar{v}t$ $d = 15 \times 4.0$ 1 mark for both relationships 1 mark for each substitution 1 mark for final answer
	(c) (i)	$F = ma$ (1) $F = 290 \times 5.0$ (1) $F = F_{\text{Driving}} - F_{\text{Friction}}$ $(290 \times 5.0) = 1800 - F_{\text{Friction}}$ (1) $F_{\text{Friction}} = 350 \text{ N}$ (1)	4	Or consistent with (a) Accept 400, 350.0, 350.00
	(ii)	Frictional force / friction / drag / air resistance increases with speed (1) Driving force must be increased to ensure a constant unbalanced force (1)	2	
	(d)	 <p>graph curves (gradually, away from velocity axis) after 5 s</p>	1	Line can level out, but not curve downwards.

2. When a car brakes kinetic energy is turned into heat and sound.

In order to make cars more efficient some manufacturers have developed kinetic energy recovery systems (KERS). These systems store some of the energy that would otherwise be lost as heat and sound.

Estimate the maximum energy that could be stored in such a system when a car brakes.

Clearly show your working for the calculation and any estimates you have made.

4

Space for working and answer



Question		Expected response	Max mark	Additional guidance
2.		Estimate of car mass (500 kg < mass < 3000 kg) (1)	4	Both estimates must be within the given tolerances in order to access the final 1 mark.
		Estimate of car speed (20 m s ⁻¹ < speed < 70 m s ⁻¹) (1)		
		$E_k = \frac{1}{2}mv^2$ (1)		
		Final answer (1)		

3. (a) A gymnast of mass 42 kg is practising on a trampoline.

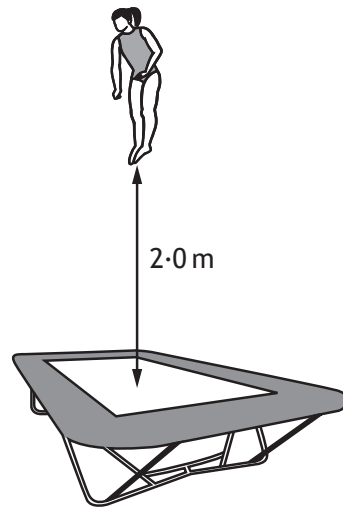

- (i) At maximum height the gymnast's feet are 2.0 m above the trampoline.

Show that the speed of the gymnast, as they land on the trampoline, is 6.3 m s^{-1} .

2

Space for working and answer

- (ii) The gymnast rebounds with a speed of 5.3 m s^{-1} .

Calculate the magnitude of the change in momentum of the gymnast.

3

Space for working and answer



MARKS

DO NOT
WRITE IN
THIS
MARGIN

3. (a) (continued)

(iii) The gymnast was in contact with the trampoline for 0.50 s.

Calculate the magnitude of the average force exerted by the trampoline on the gymnast.

3

Space for working and answer



3. (continued)

MARKS
DO NOT
WRITE IN
THIS
MARGIN

- (b) Another gymnast is practising on a piece of equipment called the rings. The gymnast grips two wooden rings suspended above the gym floor by strong vertical ropes as shown.



The gymnast now stretches out their arms until each rope makes an angle of 10° with the vertical as shown.

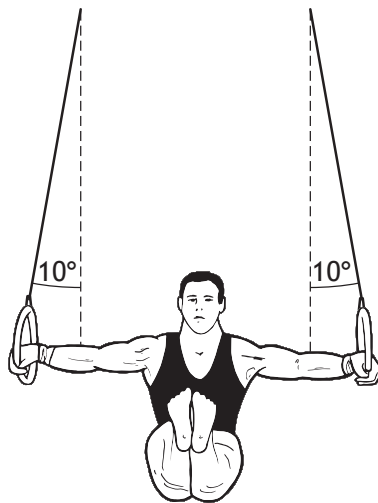

Explain why the tension in each rope increases as the gymnast stretches out their arms.

2

[Turn over



* S 8 5 7 7 6 0 1 0 9 *

Question			Expected response	Max mark	Additional guidance
3.	(a)	(i)	$v^2 = u^2 + 2as$ (1) $v^2 = 0 + 2 \times 9.8 \times 2.0$ (1) $v = 6.3 \text{ m s}^{-1}$ OR $(m)gh = \frac{1}{2}(m)v^2$ (1) $(42) \times 9.8 \times 2.0 = \frac{1}{2}(42)v^2$ (1) $v = 6.3 \text{ m s}^{-1}$	2	SHOW question. A maximum of 1 mark is available if the final line is not shown.
		(ii)	$\Delta p = mv - mu$ (1) $\Delta p = (42 \times (5.3)) - (42 \times (-6.3))$ (1) $\Delta p = 490 \text{ kg m s}^{-1}$ (1)	3	Accept 500, 487, 487.2 Accept alternative direction convention.
		(iii)	$Ft = mv - mu$ (1) $F \times 0.50 = 490$ (1) $F = 980 \text{ N}$ (1)	3	Or consistent with (a)(ii) Accept 1000, 980.0
	(b)		Tension (in rope) now has a horizontal component (1) Vertical component of tension (in rope) is unchanged (1)	2	Independent marks Statements must refer to forces on rope.

4. Muons are sub-atomic particles produced when cosmic rays enter the atmosphere about 10 km above the surface of the Earth.

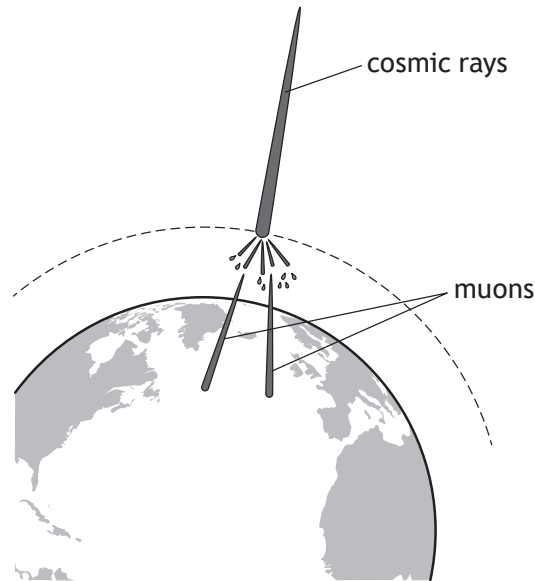

Muons have a mean lifetime of 2.2×10^{-6} s in their frame of reference. Muons are travelling at $0.995c$ relative to an observer on Earth.

- (a) Show that the mean distance travelled by the muons in their frame of reference is 660 m.

2

Space for working and answer

- (b) Calculate the mean lifetime of the muons measured by an observer on Earth.

3

Space for working and answer



4. (continued)

- (c) Explain why a greater number of muons are detected on the surface of the Earth than would be expected if relativistic effects were not taken into account.

1

[Turn over



Question		Expected response	Max mark	Additional guidance
4.	(a)	$d = \bar{v}t$ (1) $d = (3.00 \times 10^8 \times 0.995) \times 2.2 \times 10^{-6}$ (1) $d = 660 \text{ m}$	2	SHOW question. A maximum of 1 mark is available if the final line is not shown.
	(b)	$t' = \frac{t}{\sqrt{1 - \left(\frac{v}{c}\right)^2}}$ (1) $t' = \frac{2.2 \times 10^{-6}}{\sqrt{1 - \left(\frac{0.995}{1}\right)^2}}$ (1) $t' = 2.2 \times 10^{-5} \text{ s}$ (1)	3	Accept 2, 2.20, 2.203
	(c)	The mean lifetime of the muon is greater for an observer in Earth's frame of reference OR The mean distance travelled by a muon is shorter in the muon's frame of reference	1	

5. (a) The diagram below represents part of the emission spectrum for the element hydrogen.

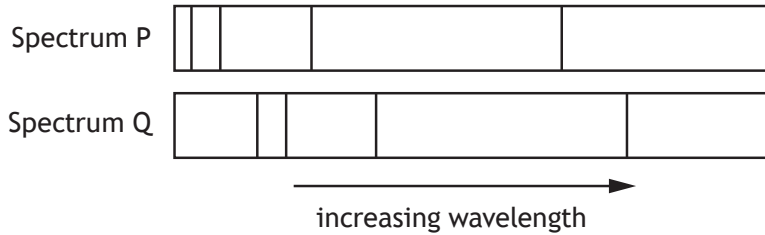

Spectrum P is from a laboratory source.

Spectrum Q shows the equivalent lines from a distant galaxy as observed on the Earth.

- (i) Explain why the lines on spectrum Q are in a different position to those on spectrum P.

2

- (ii) One of the lines in spectrum P has a wavelength of 656 nm. The equivalent line in spectrum Q is measured to have a wavelength of 676 nm.

Determine the recessional velocity of the galaxy.

5

Space for working and answer



5. (continued)

- (b) The recessional velocity of another distant galaxy is $1.2 \times 10^7 \text{ m s}^{-1}$.
Calculate the approximate distance to this galaxy.

3

Space for working and answer

- (c) A student explains the expansion of the Universe using an 'expanding balloon model'.
The student draws 'galaxies' on a balloon and then inflates it.

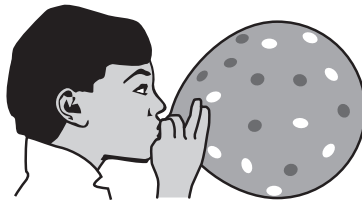

Using your knowledge of physics, comment on this model.

3



* S 8 5 7 7 6 0 1 1 3 *

Question			Expected response	Max mark	Additional guidance
5.	(a)	(i)	<p>The galaxy is moving away from Earth (1)</p> <p>The apparent wavelengths of the lines of the hydrogen spectrum from the galaxy have increased (1) OR The apparent frequencies of the lines of the hydrogen spectrum from the galaxy are less than the corresponding frequencies from the laboratory source OR The frequency of the light from the galaxy has shifted towards the red end of the spectrum OR Observed light from the galaxy shows redshift</p>	2	
		(ii)	$z = \frac{(\lambda_{obs} - \lambda_{rest})}{\lambda_{rest}} \quad (1)$ $z = \frac{(676 \times 10^{-9} - 656 \times 10^{-9})}{656 \times 10^{-9}} \quad (1)$ $z = \frac{v}{c} \quad (1)$ $\frac{(676 \times 10^{-9} - 656 \times 10^{-9})}{656 \times 10^{-9}} = \frac{v}{3.00 \times 10^8} \quad (1)$ $v = 9.15 \times 10^6 \text{ m s}^{-1} \quad (1)$	5	Accept 9.1, 9.146, 9.1463
	(b)		$v = H_0 d \quad (1)$ $1.2 \times 10^7 = 2.3 \times 10^{-18} \times d \quad (1)$ $d = 5.2 \times 10^{24} \text{ m} \quad (1)$	3	Accept 5, 5.22, 5.217

6. A linear accelerator is used to accelerate protons.
The accelerator consists of hollow metal tubes placed in a vacuum.

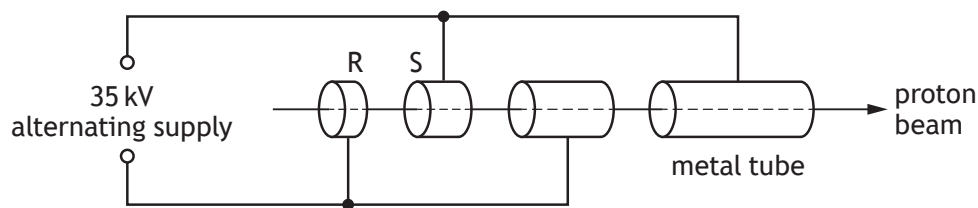

The diagram shows the path of the protons through the accelerator.
Protons are accelerated across the gaps between the tubes by a potential difference of 35 kV.

- (a) The protons are travelling at $1.2 \times 10^6 \text{ m s}^{-1}$ at point R.
- (i) Show that the work done on a proton as it accelerates from R to S is $5.6 \times 10^{-15} \text{ J}$. 2
Space for working and answer
- (ii) Determine the speed of the proton as it reaches S. 5
Space for working and answer



6. (continued)

(b) (i) Explain why an alternating supply is used in the linear accelerator. 1

(ii) Suggest one reason why the lengths of the tubes increase along the accelerator. 1

(c) In the Large Hadron Collider (LHC) beams of hadrons travel in opposite directions inside a circular accelerator and then collide. The accelerating particles are guided along the collider using strong magnetic fields.

The diagram shows a proton entering a magnetic field.

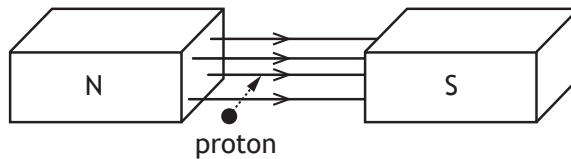

In which direction is this proton initially deflected? 1

[Turn over



Question			Expected response	Max mark	Additional guidance
6.	(a)	(i)	$W = QV$ (1) $W = 1.60 \times 10^{-19} \times 3.5 \times 10^4$ (1) $W = 5.6 \times 10^{-15} \text{ J}$	2	SHOW question. A maximum of 1 mark is available if the final line is not shown.
		(ii)	E_k at R $E_k = \frac{1}{2}mv^2$ (1) $E_k = 0.5 \times 1.673 \times 10^{-27} \times (1.2 \times 10^6)^2$ (1) E_k at S $E_k = \frac{1}{2}mv^2$ $[0.5 \times 1.673 \times 10^{-27} \times (1.2 \times 10^6)^2]$ $+ 5.6 \times 10^{-15}$ $= 0.5 \times 1.673 \times 10^{-27} \times v^2$ addition (1) substitution (1) $v = 2.9 \times 10^6 \text{ m s}^{-1}$ (1)	5	Accept 3,2.85,2.852
	(b)	(i)	To ensure the (accelerating) force is in the same direction OR To ensure the protons accelerate in the same direction OR To ensure that the direction of the electric field is correct when the proton passes through a tube	1	
	(b)	(ii)	Alternating voltage has a constant frequency (rather than a frequency that changes) OR As speed of proton increases, they travel further in the same time	1	
	(c)		Downwards	1	

7. The following diagram gives information about the Standard Model of fundamental particles and interactions.

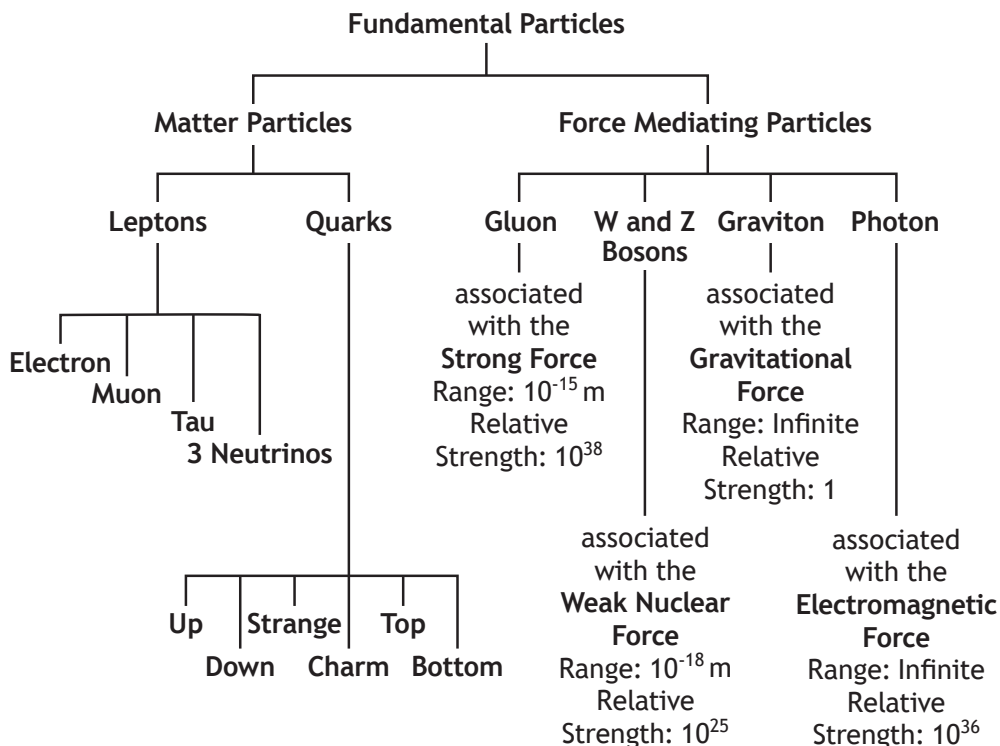

Use information from the diagram and your knowledge of the Standard Model to answer the following questions.

- (a) Explain why particles such as leptons and quarks are known as *fundamental particles*.

1

- (b) A particle called the sigma plus (Σ^+) has a charge of $+1e$. It contains two different types of quark. It has two up quarks each having a charge of $+\frac{2}{3}e$ and one strange quark.

Determine the charge on the strange quark.

1



7. (continued)

- (c) Explain why the gluon cannot be the force mediating particle for the gravitational force.

2

- (d) Compare the relative strength of the strong force with the weak nuclear force in terms of orders of magnitude.

1

- (e) A neutron decays into a proton, an electron and an antineutrino.
The equation for this decay is

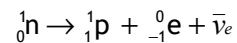

State the name of this type of decay.

1

[Turn over



* S 8 5 7 7 6 0 1 1 7 *

Question		Expected response	Max mark	Additional guidance
7.	(a)	Fundamental particles cannot be subdivided	1	
	(b)	$-\frac{1}{3}e$	1	
	(c)	The strong force (associated with the gluon) has a short range. (1) The gravitational force (requires a force mediating particle that) has infinite range. (1)	2	
	(d)	(The strong force is) 13 (orders of magnitude) greater (than the weak force)	1	
	(e)	beta decay	1	

8. The following statement represents a fusion reaction.

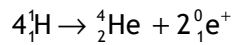

The masses of the particles involved in the reaction are shown in the table.

Particle	Mass (kg)
$\text{}^1_1\text{H}$	1.673×10^{-27}
$\text{}^4_2\text{He}$	6.646×10^{-27}
$\text{}^0_1\text{e}^+$	negligible

- (a) Calculate the energy released in this reaction.

4

Space for working and answer



* S 8 5 7 7 6 0 1 1 8 *

8. (continued)

- (b) Calculate the energy released when 0.20 kg of hydrogen is converted to helium by this reaction.

3

Space for working and answer

- (c) Fusion reactors are being developed that use this type of reaction as an energy source.

Explain why this type of fusion reaction is hard to sustain in these reactors.

1

[Turn over



* S 8 5 7 7 6 0 1 1 9 *

Question		Expected response	Max mark	Additional guidance
8.	(a)	mass loss $m = (4 \times 1.673 \times 10^{-27}) - 6.646 \times 10^{-27}$ (1) $E = mc^2$ (1) $E = ((4 \times 1.673 \times 10^{-27}) - (6.646 \times 10^{-27})) \times (3.00 \times 10^8)^2$ (1) $E = 4.14 \times 10^{-12}$ J (1)	4	Accept 4.1, 4.140, 4.1400
	(b)	0.20 kg hydrogen has $\frac{0.20}{1.673 \times 10^{-27}}$ (= 1.195×10^{26} atoms) (1) provides $\frac{1.195 \times 10^{26}}{4} = 0.2989 \times 10^{26}$ reactions (1) releases $0.2989 \times 10^{26} \times 4.14 \times 10^{-12}$ $= 1.2 \times 10^{14}$ J (1)	3	Accept 1, 1.24, 1.237 Multiplying the number of hydrogen nuclei by the energy for each reaction is wrong physics.
	(c)	The particles involved in fusion reactions must be at a high temperature	1	

9. A student carries out an experiment to investigate how irradiance on a surface varies with distance from a small lamp.

Irradiance is measured using a light meter.

The distance between the small lamp and the light meter is measured with a metre stick.

The apparatus is set up in a darkened laboratory as shown.

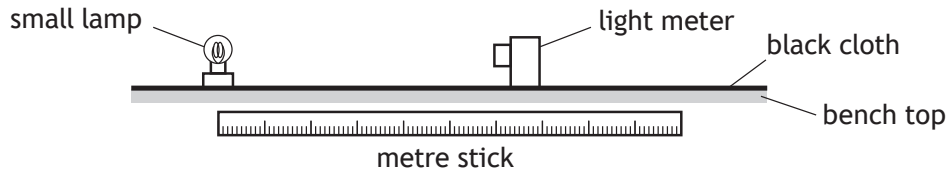

The following results are obtained.

<i>Distance from source (m)</i>	0.200	0.300	0.400	0.500
<i>Irradiance (units)</i>	672	302	170	110

- (a) State what is meant by the term *irradiance*.

1

- (b) Use **all** the data to find the relationship between irradiance I and distance d from the source.

You may wish to use the square-ruled paper on *page 37*.

3

Space for working and answer



9. (continued)

- (c) Suggest the purpose of the black cloth placed on top of the bench in the experimental setup.

1

- (d) The small lamp is replaced by a laser.

Light from the laser is shone onto the light meter.

A reading is taken from the light meter when the distance between the light meter and the laser is 0.200 m.

The distance is now increased to 0.500 m.

The reading on the light meter does not change.

Suggest why the reading on the light meter does not change.

1

[Turn over



* S 8 5 7 7 6 0 1 2 1 *

Question		Expected response	Max mark	Additional guidance															
9.	(a)	Irradiance is the power incident per unit area	1																
	(b)	Graphical method Correct quantities on axes (I and $1/d^2$) (1) Accuracy of plotting and line of best fit (1) Statement of relationship (1) Do not award statement mark if less than three points plotted accurately.	3	ALTERNATIVE METHOD <table border="1"> <tr> <td>d</td> <td>0.200</td> <td>0.300</td> <td>0.400</td> <td>0.500</td> </tr> <tr> <td>I</td> <td>672</td> <td>302</td> <td>170</td> <td>110</td> </tr> <tr> <td>Id^2</td> <td>26.9</td> <td>27.2</td> <td>27.2</td> <td>27.5</td> </tr> </table> <p>AND Within the limits of experimental uncertainty, Id^2 is constant and so $I \propto 1/d^2$.</p> <p>Award 3 marks where all four calculated values in the table are correct and the final statement is correct. Award 2 marks where all four calculated values in the table are correct and the final statement is incorrect or omitted. Award 2 marks where three calculations in the table are correct and the final statement is correct. Award 1 mark where three calculations in the table are correct and the final statement is incorrect or omitted. Award 0 marks where fewer than three calculations are correct (a relationship cannot be stated from only two values or fewer).</p>	d	0.200	0.300	0.400	0.500	I	672	302	170	110	Id^2	26.9	27.2	27.2	27.5
d	0.200	0.300	0.400	0.500															
I	672	302	170	110															
Id^2	26.9	27.2	27.2	27.5															
	(c)	(Black cloth) prevents reflections	1																
	(d)	The laser is not a point source OR Light from the laser does not conform to the inverse square law OR Laser beam does not spread out	1																

10. A metal plate emits electrons when certain wavelengths of electromagnetic radiation are incident on it.

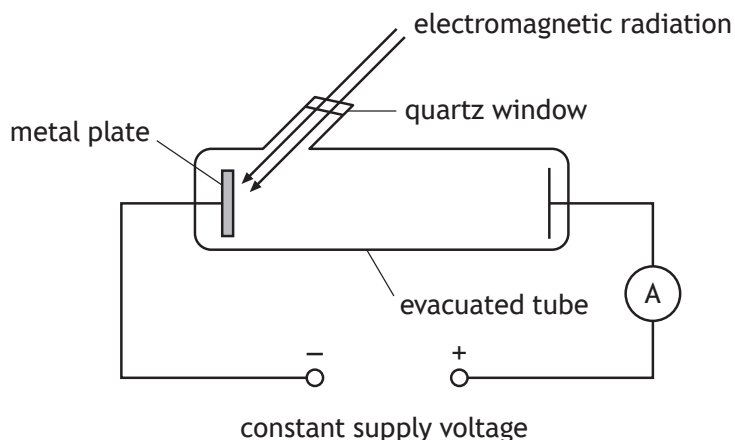

The work function of the metal is 2.24×10^{-19} J.

- (a) Electrons are released when electromagnetic radiation of wavelength 525 nm is incident on the surface of the metal plate.

- (i) Show that the energy of each photon of the incident radiation is 3.79×10^{-19} J.

4

Space for working and answer

- (ii) Determine the maximum kinetic energy of an electron released from the surface of the metal plate.

1

Space for working and answer



10. (continued)

- (b) The frequency of the incident radiation is now varied through a range of values.

The maximum kinetic energy of electrons leaving the metal plate is determined for each frequency.

A graph of this maximum kinetic energy against frequency is shown.

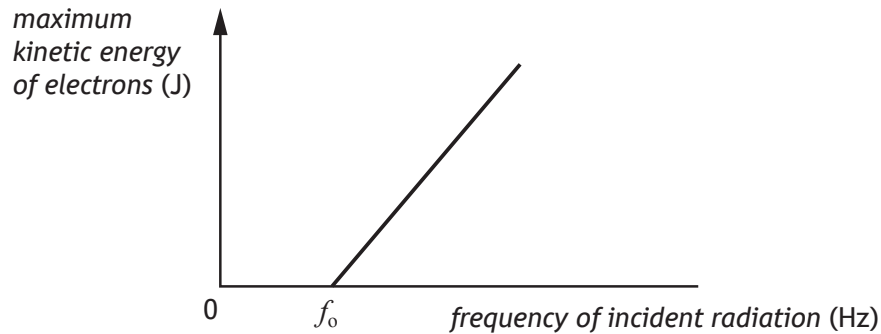

- (i) Explain why no electrons leave the metal plate when the frequency of the incident radiation is below f_0 .

1

- (ii) Calculate the frequency f_0 .
Space for working and answer

3



* S 8 5 7 7 6 0 1 2 3 *

10. (continued)

- (c) The use of analogies from everyday life can help better understanding of physics concepts. Throwing different balls at a coconut shy to dislodge a coconut is an analogy that can help understanding of the photoelectric effect .



Use your knowledge of physics to comment on this analogy.

3



Question			Expected response	Max mark	Additional guidance
10.	(a)	(i)	$v = f\lambda \quad (1)$ $3.00 \times 10^8 = f \times 525 \times 10^{-9} \quad (1)$ $E = hf \quad (1)$ $E = 6.63 \times 10^{-34} \times \left(\frac{3.00 \times 10^8}{525 \times 10^{-9}} \right) \quad (1)$ $E = 3.79 \times 10^{-19} \text{ J}$	4	SHOW question. A maximum of 3 marks is available if the final line is not shown.
		(ii)	$(E_k = 3.79 \times 10^{-19} - 2.24 \times 10^{-19})$ $E_k = 1.55 \times 10^{-19} \text{ J}$	1	
	(b)	(i)	Photons with frequency below f_0 do not have enough energy to release electrons	1	
		(ii)	$E = hf_0 \quad (1)$ $2.24 \times 10^{-19} = (6.63 \times 10^{-34}) \times f_0 \quad (1)$ $f_0 = 3.38 \times 10^{14} \text{ Hz} \quad (1)$	3	Accept 3.4, 3.379, 3.3786

11. A helium-neon laser produces a beam of monochromatic light.
A student directs this laser beam onto a double slit arrangement as shown in the diagram.

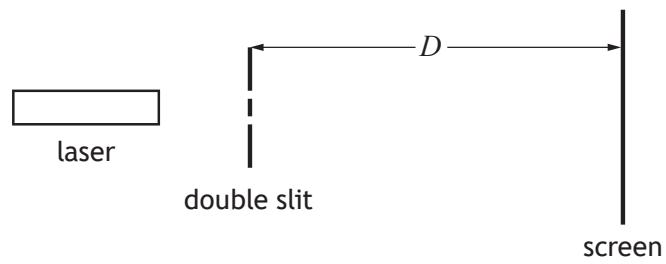

A pattern of bright red fringes is observed on the screen.

- (a) Explain, in terms of waves, why bright red fringes are produced.

1

[Turn over



11. (continued)

- (b) The average separation Δx between adjacent fringes is given by the relationship

$$\Delta x = \frac{\lambda D}{d}$$

where: λ is the wavelength of the light

D is the distance between the double slit and the screen

d is the distance between the two slits

The diagram shows the value measured by the student of the distance between a series of fringes and the uncertainty in this measurement.

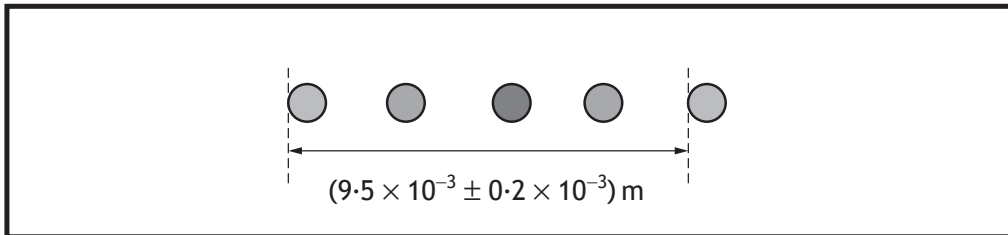

The student measures the distance D between the double slit and the screen as (0.750 ± 0.001) m.

- (i) Calculate the best estimate of the distance between the two slits.

An uncertainty in the calculated value is not required.

3

Space for working and answer



11. (b) (continued)

- (ii) The student wishes to determine more precisely the value of the distance between the two slits d .

Show, by calculation, which of the student's measurements should be taken more precisely in order to achieve this.

You must indicate clearly which measurement you have identified.

Space for working and answer

3

- (c) The helium-neon laser is replaced by a laser emitting green light. No other changes are made to the experimental set-up.

Explain the effect this change has on the separation of the fringes observed on the screen.

2

[Turn over



* S 8 5 7 7 6 0 1 2 7 *

Question		Expected response	Max mark	Additional guidance
11.	(a)	Bright fringes are produced by waves meeting in phase/crest to crest/trough to trough	1	
	(b)	(i) $\Delta x = \frac{\lambda D}{d}$ $\frac{9.5 \times 10^{-3}}{4} = \frac{633 \times 10^{-9} \times 0.750}{d}$ division by 4 (1) substitutions (1) $d = 2.0 \times 10^{-4} \text{ m}$ (1)	3	Accept 2, 2.00, 1.999 The mark for dividing by 4 is independent
		(ii) $\% \text{uncertainty} \Delta x = \frac{0.2 \times 10^{-3} \times 100}{9.5 \times 10^{-3}} = 2.1\%$ (1) $\% \text{uncertainty} D = \frac{0.001 \times 100}{0.750} = 0.13\%$ (1) Improve precision in measurement of Δx (1)	3	
	(c)	Green light has a shorter wavelength (1) Fringes are closer together (1)	2	

12. A technician investigates the path of laser light as it passes through a glass tank filled with water. The light enters the glass tank along the normal at C then reflects off a mirror submerged in the water.

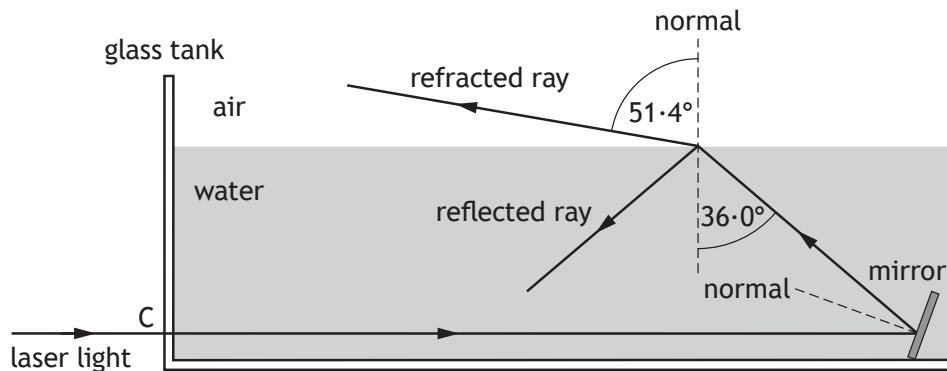

not to scale

- (a) Show that the refractive index of water for this laser light is 1.33. 2
Space for working and answer
- (b) The mirror is now adjusted until the light strikes the surface of the water at the critical angle. 1
- (i) State what is meant by the *critical angle*.
- (ii) Calculate the critical angle for this light in the water. 3
Space for working and answer



Question		Expected response	Max mark	Additional guidance
12.	(a)	$n = \frac{\sin \theta_1}{\sin \theta_2} \quad (1)$ $n = \frac{\sin(51.4)}{\sin(36.0)} \quad (1)$ $n = 1.33$	2	SHOW question. A maximum of 1 mark is available if the final line is not shown.
	(b)	(i)	1	
		(ii)	3	Accept 49, 48.75, 48.753
		$\sin \theta_c = \frac{1}{n} \quad (1)$ $\sin \theta_c = \frac{1}{1.33} \quad (1)$ $\theta_c = 48.8^\circ \quad (1)$		

13. The following circuit is used to determine the internal resistance r of a battery of EMF E .

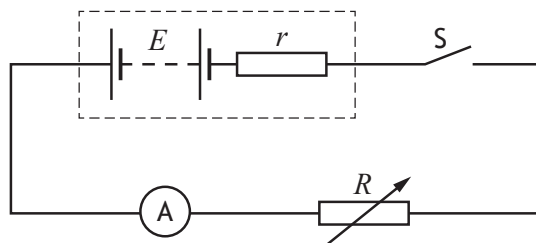

The variable resistor provides known values of resistance R .

For each value of resistance R the switch S is closed and the current I is noted.

For each current, the value of $\frac{1}{I}$ is calculated.

In one such experiment, the following graph of R against $\frac{1}{I}$ is obtained.

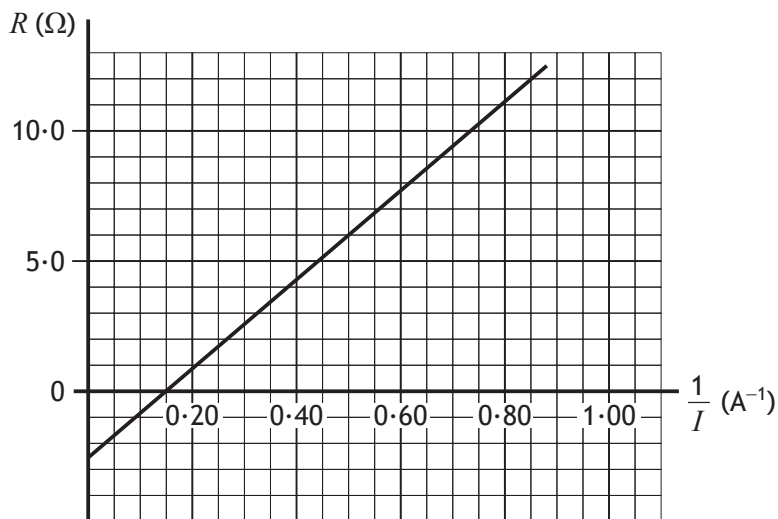

Conservation of energy applied to the complete circuit gives the following relationship.

$$R = \frac{E}{I} - r$$

This relationship is in the form of the equation of a straight line

$$y = mx + c$$

where m is the gradient and c is the y -intercept.



MARKS
DO NOT
WRITE IN
THIS
MARGIN

13. (continued)

(a) Use information from the graph to determine:

(i) the internal resistance of the battery

1

(ii) the EMF of the battery.

Space for working and answer

2

(b) The battery is accidentally short-circuited.

Calculate the current in the battery when this happens.

Space for working and answer

3



Question			Expected response	Max mark	Additional guidance
13.	(a)	(i)	2.5Ω	1	
		(ii)	$E = \frac{y_2 - y_1}{x_2 - x_1}$ $E = \frac{11 - 0}{0.80 - 0.15}$ substitution of two points on line (1) $E = 17 \text{ V}$ (1)	2	Or consistent with data points chosen
	(b)		$V = IR$ (1) $17 = I \times 2.5$ (1) $I = 6.8 \text{ A}$ (1)	3	Or consistent with (a)(i) and (a)(ii)

14. A $220\ \mu\text{F}$ capacitor is charged using the circuit shown.
The $12\ \text{V}$ battery has negligible internal resistance.

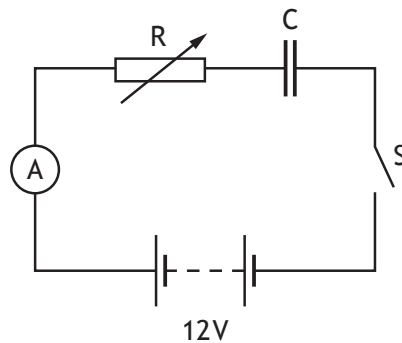

The capacitor is initially uncharged.

The switch S is closed. The charging current is kept constant at $3.0 \times 10^{-5}\ \text{A}$ by adjusting the resistance of variable resistor R .

- (a) Calculate the resistance of the variable resistor R just after the switch is closed.

3

Space for working and answer

- (b) (i) Calculate the charge on the capacitor $25\ \text{s}$ after switch S is closed.

3

Space for working and answer



MARKS

DO NOT
WRITE IN
THIS
MARGIN

14. (b) (continued)

- (ii) Calculate the potential difference across R at this time.
Space for working and answer

4



Question		Expected response	Max mark	Additional guidance
14.	(a)	$V = IR$ (1) $12 = 3.0 \times 10^{-5} \times R$ (1) $R = 4.0 \times 10^5 \Omega$ (1)	3	Accept 4, 4.00, 4.000
	(b) (i)	$Q = It$ (1) $Q = 3.0 \times 10^{-5} \times 25$ (1) $Q = 7.5 \times 10^{-4} \text{ C}$ (1)	3	Accept 8, 7.50, 7.500
	(ii)	$C = \frac{Q}{V}$ (1) $220 \times 10^{-6} = \frac{7.5 \times 10^{-4}}{V}$ (1) $V = 3.4 \text{ (V)}$ (1) Therefore voltage across resistor is $12 - 3.4 = 8.6 \text{ V}$ (1)	4	Or consistent with (b)(i) Accept 9, 8.59, 8.591

15. The electrical conductivity of solids can be explained using band theory.

The diagrams below show the distributions of the valence and conduction bands of materials classified as conductors, insulators and semiconductors.

Shaded areas represent bands occupied by electrons.

The band gap is also indicated.

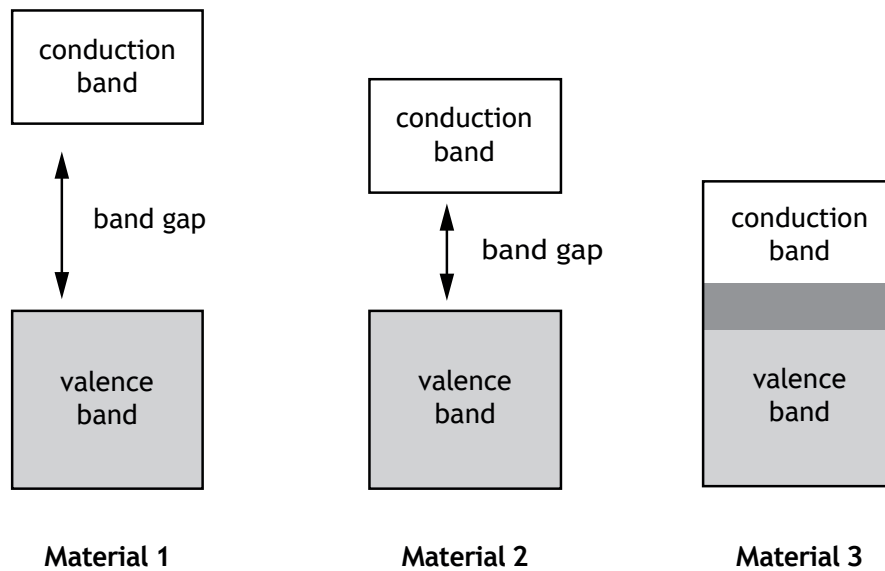

(a) State which material is a semiconductor.

1

[Turn over



15. (continued)

(b) An LED is made from semiconductor material that has been doped with impurities to create a p-n junction.

The diagram represents the band structure of an LED.

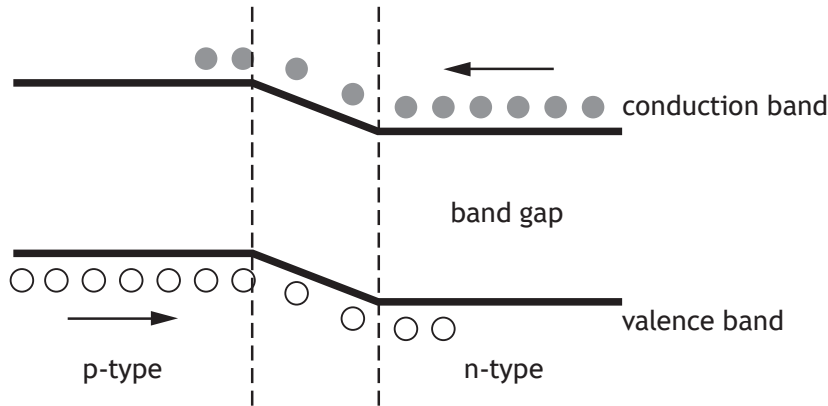

A voltage is applied across an LED so that it is forward biased and emits light.

Using **band theory**, explain how the LED emits light.

3



Question		Expected response	Max mark	Additional guidance
15.	(a)	Material 2	1	
	(b)	<p>(Voltage applied causes) electrons to move towards conduction band of p-type (1)</p> <p>Electrons move/drop from conduction band to valence band (1)</p> <p>Photon emitted (when electron drops) (1)</p>	3	<p>If candidate does not refer to either conduction band or valence band, award 0 marks.</p> <p>Bands must be named correctly in first two marking points ie not valency or conductive.</p> <p>Award 0 marks for any answer using recombination of holes and electrons on its own, with no reference to band theory.</p> <p>The final mark is dependent upon having at least one of the first two statements correct.</p>

16. A group of students carries out an experiment to investigate the transmission of light through an optical fibre.

Red light is transmitted through a loop of optical fibre and detected by a photodiode connected to a voltmeter as shown.

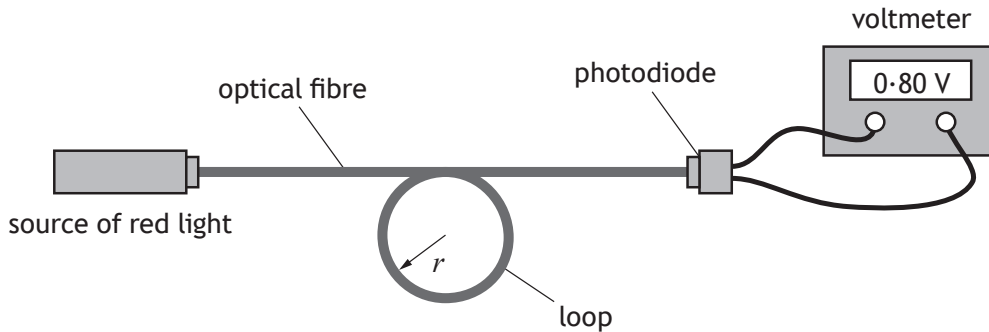

The photodiode produces a voltage proportional to the irradiance of light incident on it.

The students vary the radius, r , of the loop of the optical fibre and measure the voltage produced by the photodiode.

The results are shown in the table.

Radius of loop (mm)	Voltage (V)
5	0.48
10	0.68
15	0.76
20	0.79
30	0.80
40	0.80

- (a) Using the square-ruled paper provided on page 38, draw a graph of these results.

3

[Turn over



16. (continued)

- (b) For use in communication systems, the amount of light transmitted through a loop of optical fibre must be at least 75% of the value of the fibre with no loop.

With no loop in this fibre the reading on the voltmeter is 0.80 V.

Use your graph to estimate the minimum radius of loop when using this fibre in communication systems.

1

- (c) Using the same apparatus, the students now wish to determine a better estimate of the true value of minimum radius of loop when using this fibre in communication systems.

Suggest **two** improvements to the experimental procedure that would achieve this.

2

[END OF SPECIMEN QUESTION PAPER]



Question		Expected response	Max mark	Additional guidance
16.	(a)	Suitable scales with labels on axes (quantity and unit) (1)	3	
		Points plotted accurately (1)		
		Acceptable line(curve) of best fit (1)		
	(b)	7.5 mm \pm 1mm	1	Or consistent with graph drawn
	(c)	Repeat measurements (1)	2	
		Smaller steps/divisions/intervals in radius (around the 75% value or equivalent) (1)		

[END OF SPECIMEN MARKING INSTRUCTIONS]

Total mark — 25
Attempt ALL questions

1. The graph shows how the speed v of a car varies with time t .

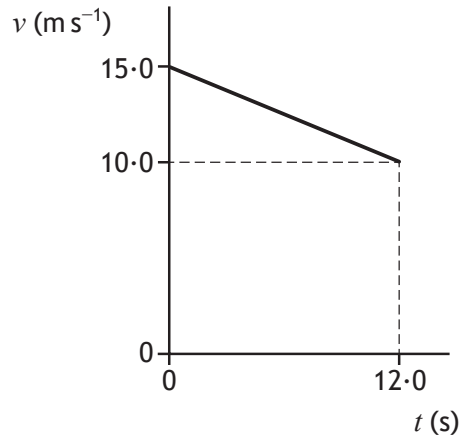

The average speed of the car during the 12.0 s is

- A 1.25 m s^{-1}
 - B 2.08 m s^{-1}
 - C 2.50 m s^{-1}
 - D 7.50 m s^{-1}
 - E 12.5 m s^{-1} .
2. A stone is thrown at 50° to the horizontal with a speed of 15 m s^{-1} .

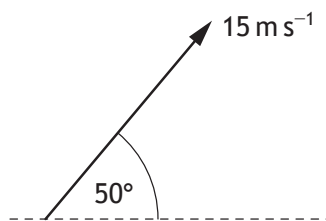

Which row in the table gives the horizontal component and the vertical component of the initial velocity of the stone?

	Horizontal component (m s^{-1})	Vertical component (m s^{-1})
A	$15 \sin 50$	$15 \cos 50$
B	$15 \cos 50$	$15 \sin 50$
C	$15 \cos 50$	$15 \sin 40$
D	$15 \cos 40$	$15 \sin 50$
E	$15 \sin 50$	$15 \cos 40$

3. A golfer strikes a golf ball, which then moves off at an angle to the ground. The ball follows the path shown.

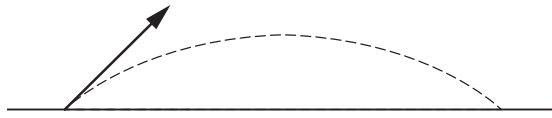

The graphs show how the horizontal component of the velocity v_h and the vertical component of the velocity v_v of the ball vary with time t .

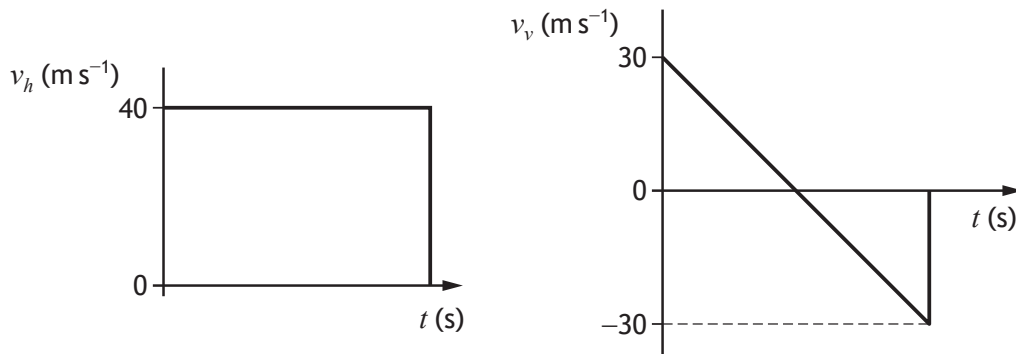

The speed of the ball just before it hits the ground is

- A 10 m s^{-1}
- B 30 m s^{-1}
- C 40 m s^{-1}
- D 50 m s^{-1}
- E 70 m s^{-1} .

4. A car accelerates from rest along a straight level road.

The acceleration of the car is constant.

Which pair of displacement-time ($s-t$) and acceleration-time ($a-t$) graphs represent the motion of the car?

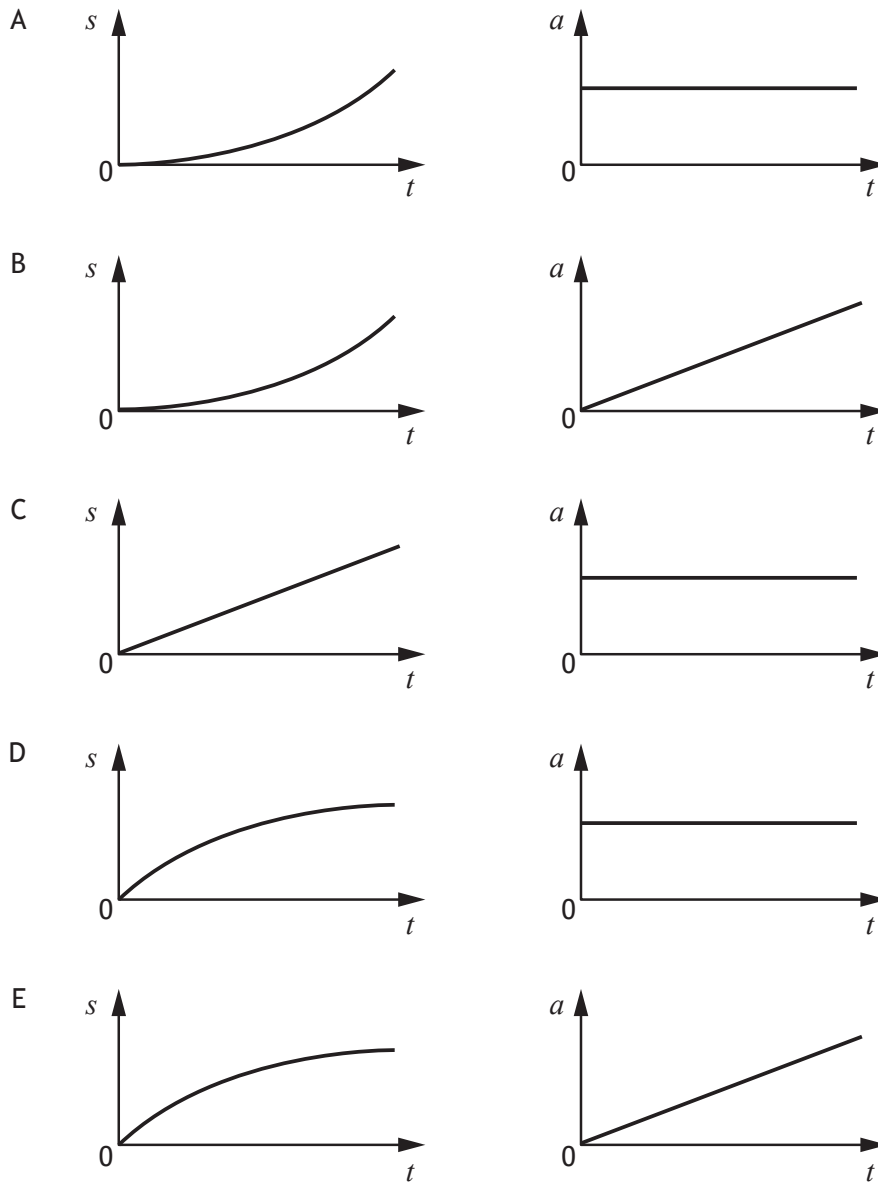

[Turn over

5. Four masses on a horizontal, frictionless surface are linked together by strings P, Q and R. A constant force is applied as shown.

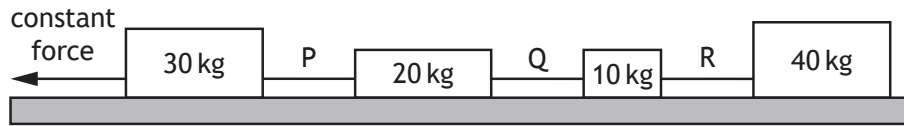

The tension in the strings is

- A greatest in P and least in Q
 - B greatest in P and least in R
 - C greatest in R and least in Q
 - D greatest in R and least in P
 - E the same in P, Q and R.
6. A student makes the following statements about an elastic collision.
- I Total momentum is conserved.
 - II Total kinetic energy is conserved.
 - III Total energy is conserved.

Which of these statements is/are correct?

- A I only
- B II only
- C I and II only
- D I and III only
- E I, II and III

7. The terminal velocity v_t of a skydiver is given by the relationship

$$v_t = \sqrt{\frac{2mg}{\rho AC_d}}$$

where

m is the mass of the skydiver in kg

g is the gravitational field strength in N kg^{-1}

C_d is the drag coefficient

ρ is the density of air in kg m^{-3}

A is the area of the skydiver in m^2 .

When in freefall, a skydiver of mass 95 kg has a drag coefficient of 1.0 and a terminal velocity of 44 m s^{-1} .

The gravitational field strength is 9.8 N kg^{-1} and the density of air is 1.21 kg m^{-3} .

The area of the skydiver is

- A 0.59 m^2
 - B 0.79 m^2
 - C 0.89 m^2
 - D 4.2 m^2
 - E 35 m^2 .
8. A spacecraft is travelling at a constant speed relative to a nearby planet.
A technician on the spacecraft measures the length of the spacecraft as 275 m.
An observer on the planet measures the length of the spacecraft as 125 m.
The speed of the spacecraft relative to the observer on the nearby planet is
- A $1.54 \times 10^4 \text{ m s}^{-1}$
 - B $2.22 \times 10^8 \text{ m s}^{-1}$
 - C $2.67 \times 10^8 \text{ m s}^{-1}$
 - D $3.00 \times 10^8 \text{ m s}^{-1}$
 - E $7.14 \times 10^{16} \text{ m s}^{-1}$.

[Turn over

9. The redshift of a distant galaxy is 0.014.

According to Hubble's law, the distance of the galaxy from Earth is

- A 9.66×10^{-12} m
- B 1.83×10^{24} m
- C 1.30×10^{26} m
- D 9.32×10^{27} m
- E 6.33×10^{39} m.

10. A student makes the following statements about the Universe.

- I The force due to gravity acts against the expansion of the Universe.
- II Measurements show the rate of expansion of the Universe is increasing.
- III The mass of a galaxy can be estimated by the orbital speed of the stars within the galaxy.

Which of these statements is/are correct?

- A I only
- B II only
- C III only
- D I and II only
- E I, II and III

11. An alpha particle is accelerated in an electric field between metal plates P and Q.

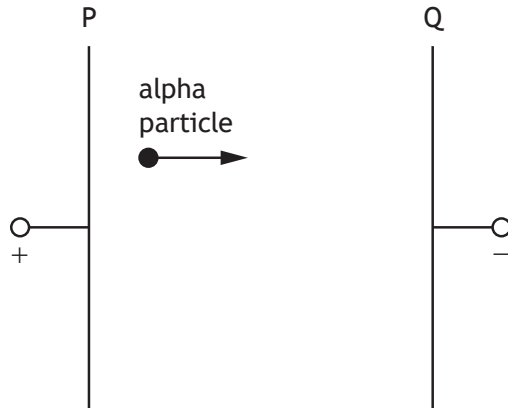

The charge on the alpha particle is $3.2 \times 10^{-19} \text{ C}$.

The kinetic energy gained by the alpha particle while travelling from plate P to plate Q is $8.0 \times 10^{-16} \text{ J}$.

The potential difference across plates P and Q is

- A $2.6 \times 10^{-34} \text{ V}$
- B $2.0 \times 10^{-4} \text{ V}$
- C $4.0 \times 10^{-4} \text{ V}$
- D $2.5 \times 10^3 \text{ V}$
- E $5.0 \times 10^3 \text{ V}$.

[Turn over

12. An electron enters a region of uniform magnetic field as shown.

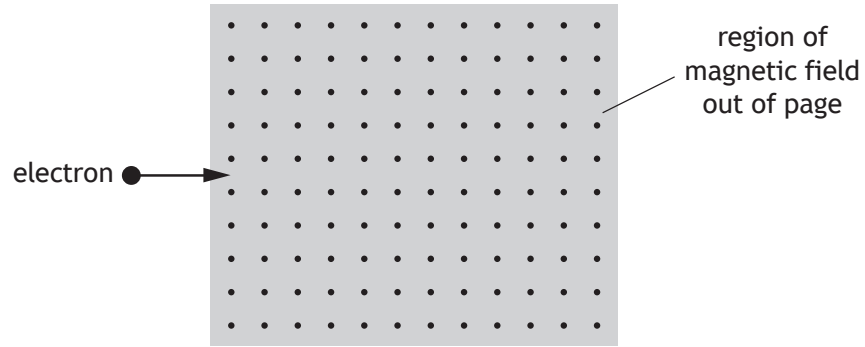

The direction of the magnetic force on the electron immediately after entering the field is

- A towards the top of the page
- B towards the bottom of the page
- C towards the right of the page
- D into the page
- E out of the page.

13. A student makes the following statements about the Standard Model.

- I Every particle has an antiparticle.
- II Alpha decay is evidence for the existence of the neutrino.
- III The W-boson is associated with the strong nuclear force.

Which of these statements is/are correct?

- A I only
- B II only
- C III only
- D I and II only
- E I and III only

14. A nucleus represented by ${}_{87}^{223}\text{Fr}$ decays by beta emission.

The symbol representing the nucleus formed as a result of this decay is

- A ${}_{87}^{224}\text{Fr}$
- B ${}_{87}^{222}\text{Fr}$
- C ${}_{88}^{223}\text{Ra}$
- D ${}_{86}^{223}\text{Rn}$
- E ${}_{88}^{224}\text{Ra}$.

[Turn over

15. The diagram shows an experiment set up to investigate the photoelectric effect. The frequency of the incident radiation is varied and the current in the circuit is measured.

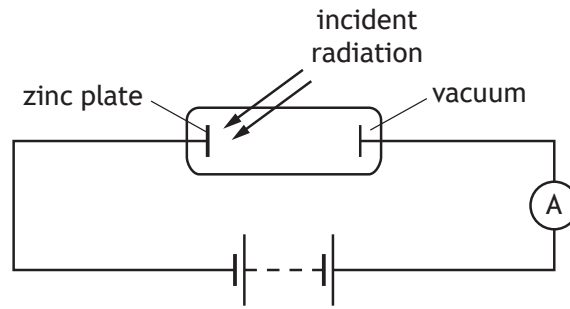

Which graph shows the relationship between the current I in the circuit and the frequency f of the incident radiation?

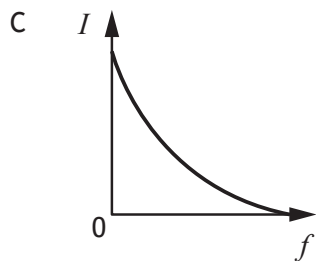
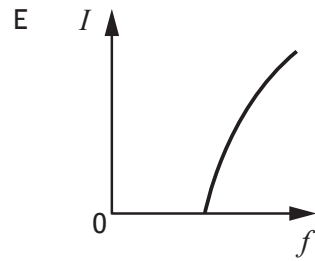
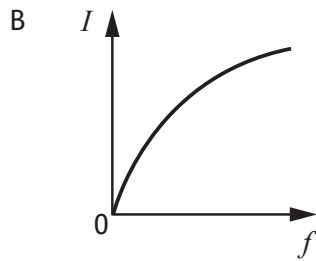
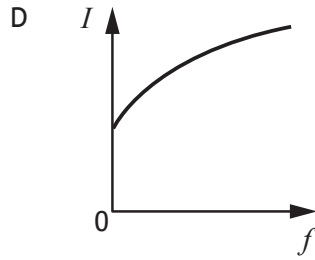
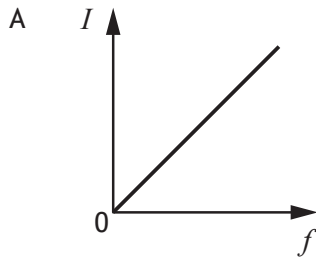

16. A photon of energy 6.40×10^{-19} J is incident on a metal plate.
 This causes photoemission to take place.
 The work function of the metal is 4.20×10^{-19} J.
 The maximum speed of the photoelectron is

- A $1.19 \times 10^6 \text{ m s}^{-1}$
- B $9.60 \times 10^5 \text{ m s}^{-1}$
- C $6.95 \times 10^5 \text{ m s}^{-1}$
- D $6.79 \times 10^5 \text{ m s}^{-1}$
- E $4.91 \times 10^5 \text{ m s}^{-1}$.

17. Waves from two coherent sources, S_1 and S_2 , produce an interference pattern.
 Maxima are detected at the positions shown.

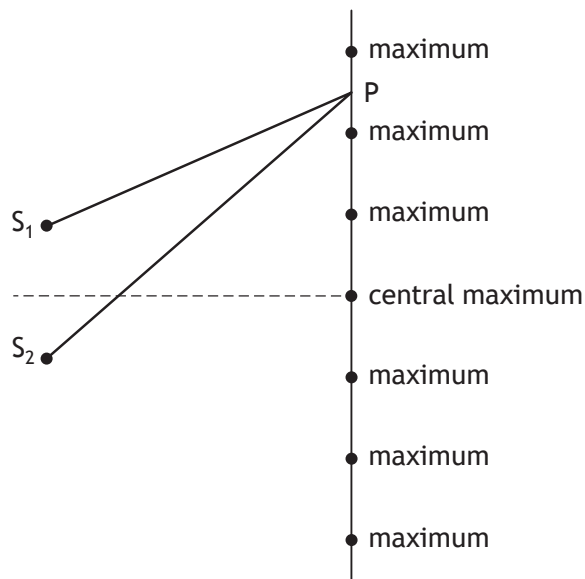

The wavelength of the waves is 28 mm.
 For the third **minimum** at P the path difference ($S_2P - S_1P$) is

- A 42 mm
- B 56 mm
- C 70 mm
- D 84 mm
- E 98 mm.

[Turn over

18. A ray of monochromatic light passes from air into water.

The wavelength of this light in air is 589 nm.

The speed of this light in water is

- A $2.56 \times 10^2 \text{ m s}^{-1}$
 - B $4.52 \times 10^2 \text{ m s}^{-1}$
 - C $2.26 \times 10^8 \text{ m s}^{-1}$
 - D $3.00 \times 10^8 \text{ m s}^{-1}$
 - E $3.99 \times 10^8 \text{ m s}^{-1}$.
19. When light passes through the outer layers of the Sun certain frequencies of light are absorbed by hydrogen atoms, producing dark lines in the spectrum.

The diagram represents some of the energy levels for a hydrogen atom.

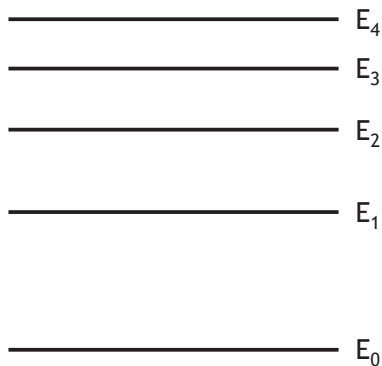

The number of absorption lines in the spectrum caused by the transition of electrons between these energy levels is

- A 4
- B 6
- C 9
- D 10
- E 20.

20. The output from an AC power supply is connected to an oscilloscope. The trace seen on the oscilloscope screen is shown.

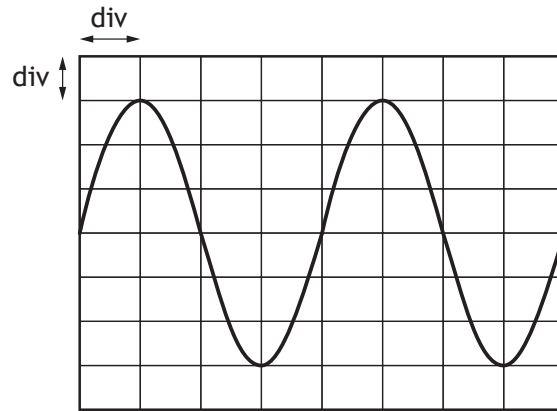

The Y-gain setting on the oscilloscope is 1.0V/div.

The rms voltage of the power supply is

- A 2.1V
- B 3.0V
- C 4.0V
- D 4.2V
- E 6.0V.

[Turn over

21. The output from a signal generator is connected to an oscilloscope. The trace observed on the oscilloscope screen is as shown in the diagram.

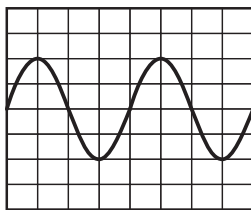

The frequency of the signal from the signal generator is now doubled.

The amplitude of the signal is unchanged.

The Y-gain setting on the oscilloscope is unchanged.

The timebase setting on the oscilloscope is changed from 1.0 ms/division to 0.5 ms/division.

Which of the following diagrams shows the trace that is now observed on the oscilloscope screen?

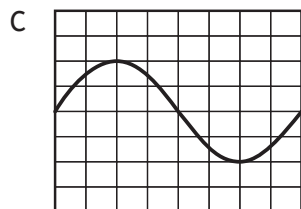
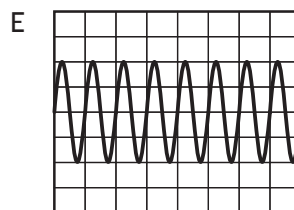
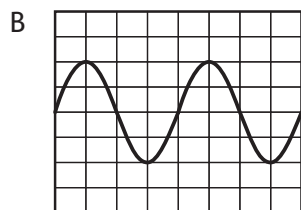
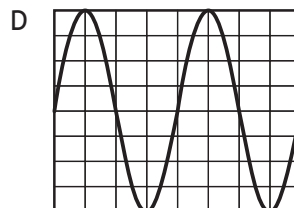
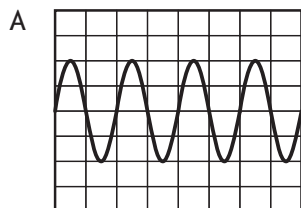

22. A student sets up a circuit and measures the voltage across and the current in a resistor. The measurements and their uncertainties are

$$\text{voltage} = (10.0 \pm 0.1) \text{ V}$$

$$\text{current} = (0.50 \pm 0.01) \text{ A}$$

The approximate absolute uncertainty in the calculated value of the resistance of the resistor is

- A $\pm 0.11 \Omega$
 - B $\pm 0.2 \Omega$
 - C $\pm 0.4 \Omega$
 - D $\pm 1 \Omega$
 - E $\pm 2 \Omega$.
23. A circuit is set up as shown.

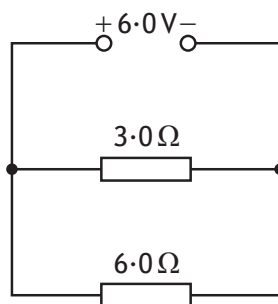

The power supply has negligible internal resistance.

The power dissipated in the 3.0Ω resistor is

- A 3.0 W
- B 6.0 W
- C 9.0 W
- D 12 W
- E 18 W.

[Turn over

24. A student connects four identical light emitting diodes (LEDs) to a 2 V DC supply as shown.

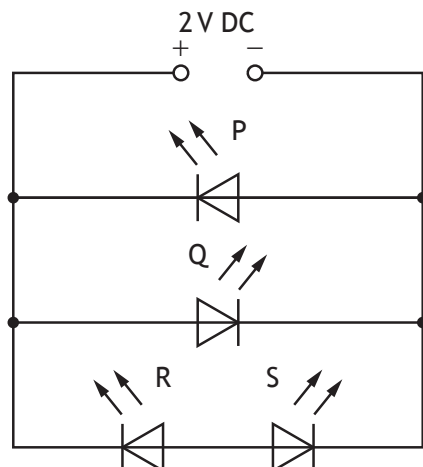

Which of the LEDs P, Q, R, and S will light?

- A P only
 - B Q only
 - C P and Q only
 - D P and R only
 - E Q and S only.
25. A student makes the following statements about uncertainties.
- I All measurements of physical quantities are liable to uncertainties.
 - II Random uncertainties occur when a measurement is repeated and slight variations occur.
 - III Systematic uncertainties in a quantity occur when measurements are either all smaller or all larger than the true value of the quantity.

Which of these statements is/are correct?

- A I only
- B I and II only
- C I and III only
- D II and III only
- E I, II and III

[END OF QUESTION PAPER]

Marking instructions for each question

Question	Answer	Mark
1.	E	1
2.	B	1
3.	D	1
4.	A	1
5.	B	1
6.	E	1
7.	B	1
8.	C	1
9.	B	1
10.	E	1
11.	D	1
12.	A	1
13.	A	1
14.	C	1
15.	E	1
16.	C	1
17.	C	1
18.	C	1
19.	D	1
20.	A	1
21.	B	1
22.	C	1
23.	D	1
24.	B	1
25.	E	1

[END OF MARKING INSTRUCTIONS]

Total marks — 130
Attempt ALL questions

1. A student carries out an experiment with a tennis ball and a motion sensor connected to a laptop.

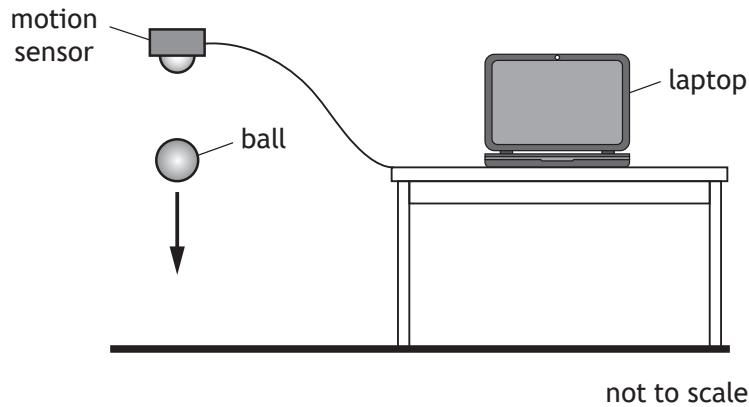

The ball is released from rest below the sensor.

The graph shows how the vertical velocity v of the ball varies with time t , from the moment the ball is released until it rebounds to its new maximum height.

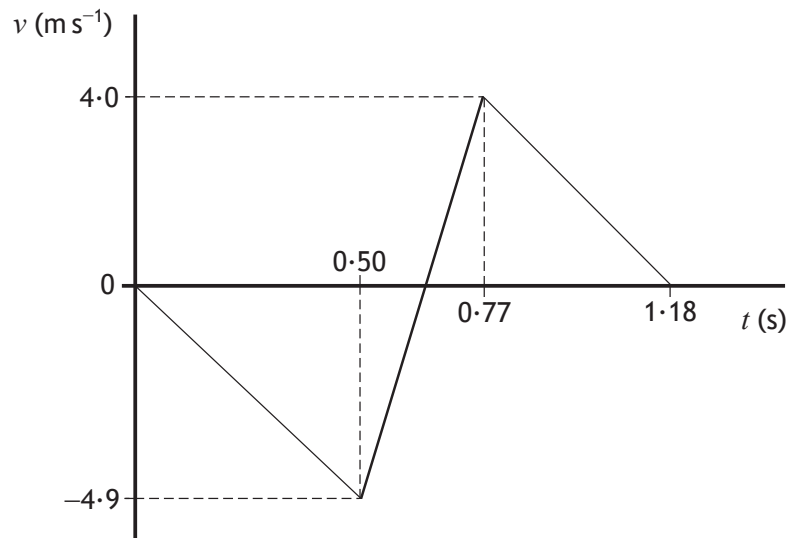

MARKS
DO NOT
WRITE IN
THIS
MARGIN

1. (continued)

(a) Using information from the graph

(i) show that the initial acceleration of the ball is -9.8 m s^{-2}

2

Space for working and answer

(ii) determine the height from which the ball is released.

3

Space for working and answer

* X 8 5 7 7 6 0 1 0 5 *

1. (continued)

(b) The mass of the ball is 57.0 g.

- (i) Determine the magnitude of the change in momentum of the ball during the bounce.

3

Space for working and answer

- (ii) Determine the magnitude of the average force exerted by the ball on the ground during the bounce.

3

Space for working and answer



* X 8 5 7 7 6 0 1 0 6 *

1. (continued)

- (c) Complete the sketch graph of acceleration a against time t for the ball, between 0 s and 1.18 s after it is released.

Numerical values are **not** required on the acceleration axis.

(An additional graph, if required, can be found on *page 44*)

2

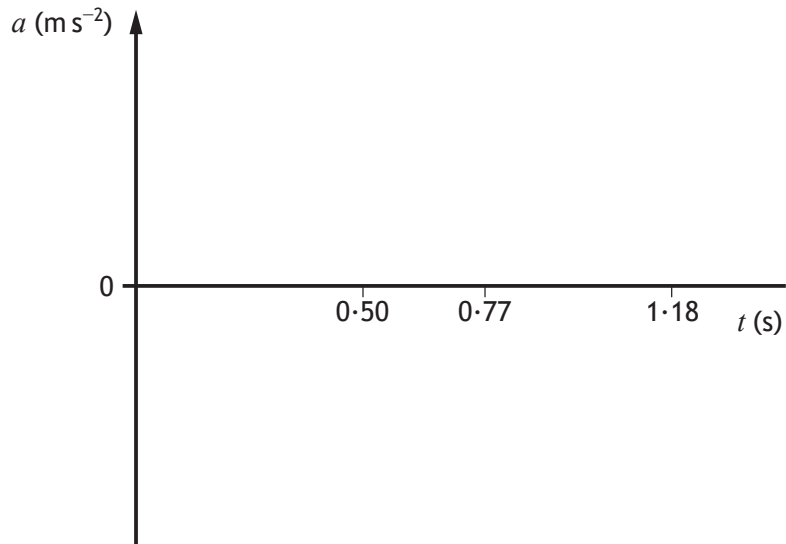

[Turn over



Question			Expected response	Max mark	Additional guidance
1.	(a)	(i)	$v = u + at$ $-4.9 = 0 + a \times 0.50$ $a = -9.8 \text{ m s}^{-2}$	<p>(1)</p> <p>(1)</p>	<p>2</p> <p>SHOW QUESTION.</p> <p>Do not accept: $a = \frac{v}{t}$</p> <p>Must show substitution for u and must use the sign convention given in the question.</p> <p>Alternative method:</p> $a = \frac{\Delta v}{t}$ $= \frac{-4.9}{0.50}$ $= -9.8 \text{ m s}^{-2}$ <p>Accept methods starting with</p> $a = \text{gradient}$ <p>OR</p> $a = \frac{\Delta v}{\Delta t}$ <p>OR</p> $a = \frac{y_2 - y_1}{x_2 - x_1}$

Question		Expected response	Max mark	Additional guidance
	(ii)	$s = ut + \frac{1}{2}at^2 \quad (1)$ $= 0 \times 0.50 + \frac{1}{2} \times (-)9.8 \times (0.50)^2 \quad (1)$ $= (-)1.2 \text{ m} \quad (1)$	3	<p>Accept: 1, 1.23, 1.225</p> <p>Sign convention must be consistent for all methods.</p> <p>Alternative methods: v and a must have same sign $v^2 = u^2 + 2as$ $((-)4.9)^2 = 0^2 + 2 \times (-)9.8 \times s$ $s = (-)1.2 \text{ m}$</p> $s = \frac{1}{2}(u+v)t$ $s = \frac{1}{2}(0 + (-)4.90) \times 0.50$ $s = (-)1.2 \text{ m}$ <p>$s = \text{area under the graph}$</p> $s = \frac{1}{2} \times 0.5 \times (-)4.9$ $s = (-)1.2 \text{ m}$
(b)	(i)	$\Delta mv = mv - mu \quad (1)$ $= (0.0570 \times 4.0) - (0.0570 \times -4.9) \quad (1)$ $= 0.51 \text{ kg m s}^{-1} \quad (1)$	3	<p>Accept: 0.5, 0.507, 0.5073</p> <p>Accept: $\Delta p = m\Delta v$ $Ft = mv - mu$</p> <p>Do not accept: $p = mv - mu - 0$ marks</p> <p>Sign convention must be consistent within this part of the question. v and u must have opposite signs.</p> $p = mv \quad (1)$ <p>all substitutions including subtraction (1) final answer (1)</p>

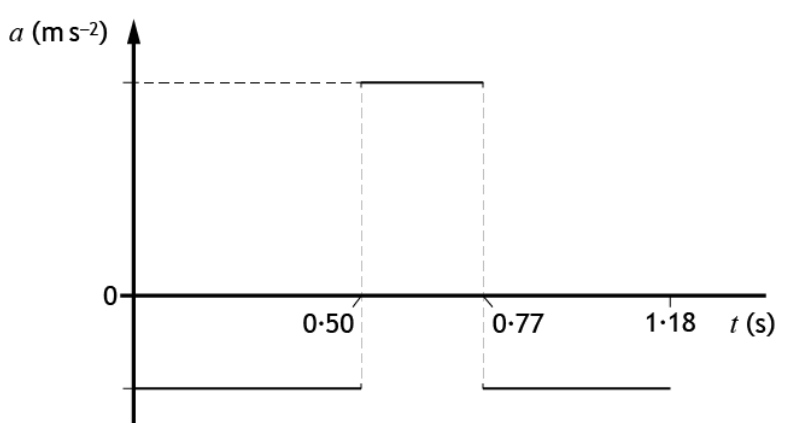
Question			Expected response	Max mark	Additional guidance
1.	(b)	(ii)	$Ft = mv - mu$ (1) $F \times 0.27 = 0.51$ (1) $F = 1.9 \text{ N}$ (1)	3	Or consistent with (b)(i) Accept: 2, 1.89, 1.889 Alternative method: Sign convention must be consistent for this method. v and u must have opposite signs. $v = u + at$ $4.0 = -4.9 + a \times 0.27$ $(a = 32.96296296 \text{ (ms}^{-2}\text{)})$ $F = ma$ $F = 0.0570 \times 32.96296296$ $F = 1.9 \text{ N}$ For this method accept 2, 1.88, 1.879 Both relationships (1) Both substitutions (1) Final answer (1)
		(c)	Same constant negative acceleration between 0 and 0.50 s and between 0.77 and 1.18 s (1) Constant positive acceleration between the two negative accelerations. Positive acceleration must be (clearly) greater than the negative acceleration (1)	2	Accept solid vertical lines If values are included on the acceleration axis, they must be correct (-9.8 and 33). If no positive acceleration is shown, maximum (1 mark) for a constant negative acceleration between 0 and 1.18 s.
			$a \text{ (ms}^{-2}\text{)}$ 		

2. A student abseils down the outside of a building using a rope.

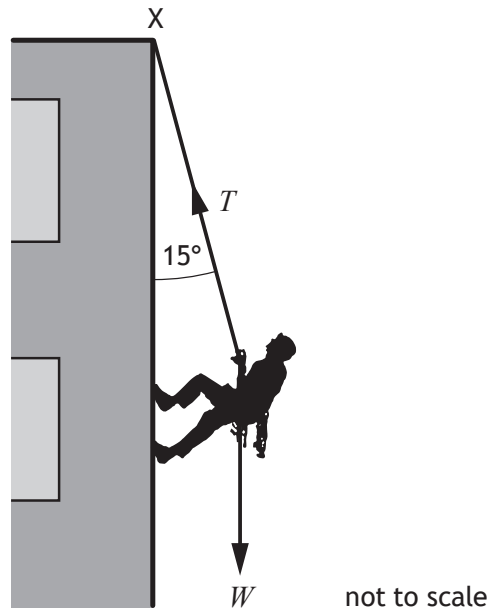

The mass of the student is 55 kg.

The rope, of negligible mass, is attached to a fixed point X at the top of the building.

The rope makes an angle of 15° to the building.

- (a) Calculate the weight W of the student.

Space for working and answer

3



MARKS
DO NOT
WRITE IN
THIS
MARGIN

2. (continued)

(b) Determine the tension T in the rope.*Space for working and answer*

3

(c) As the student abseils down the building the angle the rope makes with the building decreases.

State whether the tension in the rope increases, decreases or stays the same.

Justify your answer.

2

[Turn over

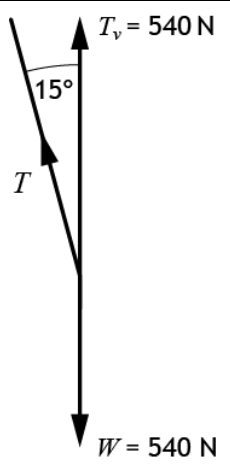

* X 8 5 7 7 6 0 1 0 9 *

Question		Expected response	Max mark	Additional guidance
2.	(a)	$W = m$ (1) $= 55 \times 9.8$ (1) $= 540 \text{ N}$ (1)	3	Accept: 500, 539, 539.0 Accept: $F = mg$ Do not accept: $F = ma$ - 0 marks
	(b)	 $T_v = T \cos \theta$ (1) $540 = T \cos 15$ (1) $T = 560 \text{ N}$ (1)	3	Or consistent with (a) Accept: 600, 559, 559.0 Accept: 600, 558, 558.0 for this value of W Accept: $W = T \cos \theta$ Ignore any indication of direction given.
	(c)	(Tension) decreases (1) (As the angle decreases) the cosine of the angle increases (1) OR the horizontal (component of the) force decreases OR shown by calculation with smaller angle	2	Look for this statement first - if incorrect or missing then (0 marks) .

3. A footballer tells teammates that a football can be kicked a much greater distance when the ball is initially travelling towards them, compared to kicking a stationary ball.



Use your knowledge of physics to comment on this statement.

3



* X 8 5 7 7 6 0 1 1 0 *

4. A communications satellite orbits the Earth at a height of 36.0×10^6 m above the surface of the Earth.

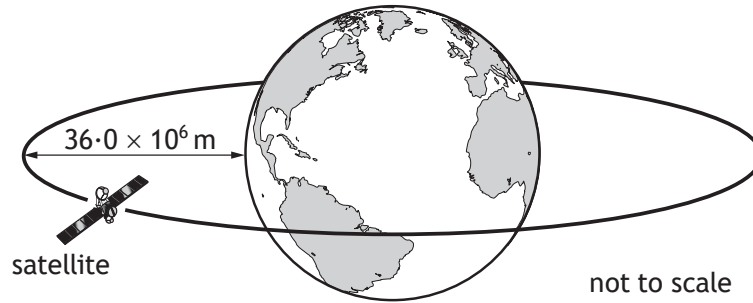

The mass of the Earth is 6.0×10^{24} kg and the radius of the Earth is 6.4×10^6 m.

- (a) Determine the distance between the centre of the Earth and the satellite. **1**
Space for working and answer

- (b) The gravitational force of attraction between the Earth and the satellite is 57 N. **3**
Calculate the mass of the satellite.
Space for working and answer



4. (continued)

- (c) Determine the value of the Earth's gravitational field strength g at the satellite.

3

Space for working and answer

- (d) A second satellite has a **quarter** of the mass of the first satellite.

The distance from the centre of the Earth to the second satellite is **half** the distance from the centre of the Earth to the first satellite.

State how the gravitational force of attraction between the second satellite and the Earth compares to the gravitational force of attraction between the first satellite and the Earth.

Justify your answer.

3



* X 8 5 7 7 6 0 1 1 3 *

Question		Expected response	Max mark	Additional guidance
4.	(a)	(distance = $6.4 \times 10^6 + 36.0 \times 10^6$) = 42.4×10^6 m	1	
	(b)	$F = G \frac{m_1 m_2}{r^2}$ (1) $57 = 6.67 \times 10^{-11} \times \frac{6.0 \times 10^{24} \times m_2}{(42.4 \times 10^6)^2}$ (1) $m_2 = 260$ kg (1)	3	Or consistent with (a) Accept: 300, 256, 256.1
	(c)	$W = mg$ (1) $57 = 260 \times g$ (1) $g = 0.22 \text{ N kg}^{-1}$ (1)	3	Or consistent with (b) Accept: 0.2, 0.219, 0.2192 Accept: $F = mg$ Do not accept: $F = ma$ - (0 marks) Alternative method: $g = G \frac{M}{r^2}$ (1) $g = 6.67 \times 10^{-11} \times \frac{6.0 \times 10^{24}}{(42.4 \times 10^6)^2}$ (1) $g = 0.22 \text{ N kg}^{-1}$ (1)
	(d)	Force is the same (1) $\frac{1}{4}$ the mass has an effect of quartering the force (1) $\frac{1}{2}$ the orbital height has an effect of quadrupling the force (1)	3	Look for this statement first - if incorrect or missing then 0 marks. Can justify by calculation Correct substitution of $\frac{1}{2}r$ and $\frac{1}{4}m$ or consistent with (a) and (b) (1) Correct final answer (1)

5. (a) A person is standing at the side of a road. A car travels along the road towards the person, at a constant speed of 12 m s^{-1} . The car emits a sound of frequency 510 Hz .

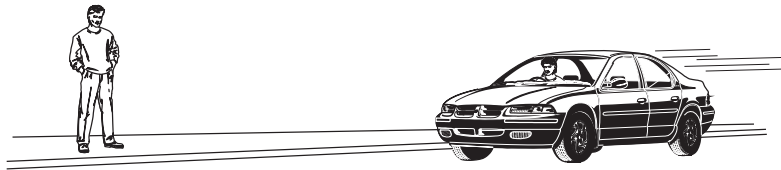

The person observes that the frequency of the sound heard changes as the car passes.

- (i) State the name given to this effect.

1

- (ii) Calculate the frequency of the sound heard by the person as the car approaches.

The speed of sound in air is 340 m s^{-1} .

3

Space for working and answer



5. (continued)

MARKS
DO NOT
WRITE IN
THIS
MARGIN

- (b) This same effect is used to determine the speed of red blood cells through blood vessels.

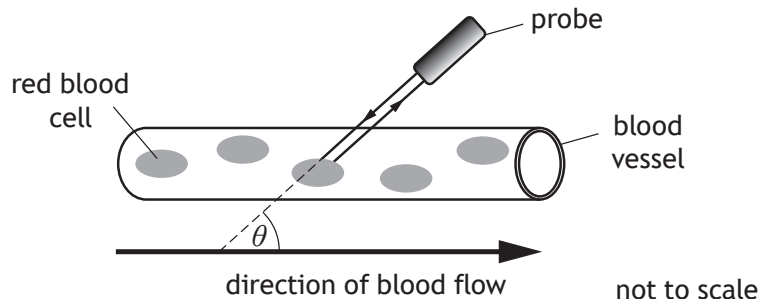

Ultrasound waves are transmitted by a probe. The frequency of the ultrasound waves changes as they reflect from the blood cells. The probe detects the reflected waves.

The velocity of the red blood cells can be determined using the following relationship

$$\Delta f = \frac{2f v_{rbc} \cos\theta}{v}$$

where Δf is the change in frequency

f is the transmitted frequency

v_{rbc} is the velocity of the red blood cells

v is the velocity of the ultrasound

θ is the angle between the direction of the waves and the direction of the blood flow.

The frequency of the ultrasound transmitted by the probe is 3.70 MHz.

The velocity of the ultrasound is 1540 m s⁻¹.

During one test, the angle between the direction of the waves and blood flow is 60.0°. The change in frequency of the ultrasound is 286 Hz.

Calculate the velocity of the red blood cells during this test.

2

Space for working and answer



* X 8 5 7 7 6 0 1 1 5 *

Question			Expected response	Max mark	Additional guidance
5.	(a)	(i)	Doppler (effect)	1	
		(ii)	$f_0 = f_s \left(\frac{v}{v \pm v_s} \right) \quad (1)$ $f_0 = 510 \left(\frac{340}{340 - 12} \right) \quad (1)$ $f_0 = 530 \text{ Hz} \quad (1)$	3	Accept: 500, 529, 528.7 Accept: $f_0 = f_s \left(\frac{v}{v - v_s} \right)$
	(b)		$\Delta f = \frac{2f v_{rbc} \cos \theta}{v}$ $286 = \frac{2 \times 3.70 \times 10^6 \times v_{rbc} \cos 60^\circ}{1540} \quad (1)$ $v_{rbc} = 0.119 \text{ ms}^{-1} \quad (1)$	2	Accept: 0.12, 0.1190, 0.11904

6. Stars emit radiation with a range of wavelengths. The peak wavelength of the radiation depends on the surface temperature of the star.
- (a) The graph shows how the energy emitted per second per unit area varies with the wavelength λ of the radiation for a star with a surface temperature of 5000 K.

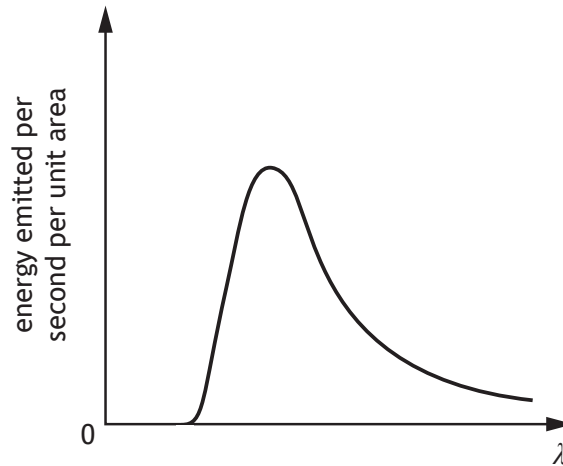

A second star has a surface temperature of 6000 K.

On the graph above, add a line to show how the energy emitted per second per unit area varies with the wavelength λ of the radiation for the second star.

2

(An additional graph, if required, can be found on page 44)



6. (continued)

- (b) The table gives the surface temperature T , in kelvin, of four different stars and the peak wavelength λ_{peak} of radiation emitted from each star.

T (K)	λ_{peak} (m)
7700	3.76×10^{-7}
8500	3.42×10^{-7}
9600	3.01×10^{-7}
12 000	2.42×10^{-7}

Use all the data in the table to show that the relationship between the surface temperature T of a star and the peak wavelength λ_{peak} radiated from the star is

3

$$T = \frac{2.9 \times 10^{-3}}{\lambda_{peak}}$$

Space for working and answer

[Turn over



* X 8 5 7 7 6 0 1 1 7 *

Question		Expected response	Max mark	Additional guidance
6.	(a)		2	Peak wavelength less (1) Line added should always be above original line (1)
	(b)	$7700 \times 3.76 \times 10^{-7} = 2.9 \times 10^{-3}$ $8500 \times 3.42 \times 10^{-7} = 2.9 \times 10^{-3}$ $9600 \times 3.01 \times 10^{-7} = 2.9 \times 10^{-3}$ $12000 \times 2.42 \times 10^{-7} = 2.9 \times 10^{-3}$ <p style="text-align: right;">(2)</p> <p>therefore</p> $T \times \lambda_{peak} = 2.9 \times 10^{-3}$ <p style="text-align: right;">(1)</p>	3	All four calculations correct (2) Three correct calculations (1) < Three correct calculations (0)
				$7700 \times 3.76 \times 10^{-7} = 2.895 \times 10^{-3}$ $8500 \times 3.42 \times 10^{-7} = 2.907 \times 10^{-3}$ $9600 \times 3.01 \times 10^{-7} = 2.890 \times 10^{-3}$ $12000 \times 2.42 \times 10^{-7} = 2.904 \times 10^{-3}$ <p>therefore</p> $T \times \lambda_{peak} = 2.9 \times 10^{-3}$ <p style="text-align: right;">(1)</p> <p>This 'conclusion' mark is only available if consistent with the calculations shown.</p> <p>For 'finding the constant' method, accept restatement of relationship for final mark.</p> <p>Alternative methods:</p> <p>Can calculate the temperatures or wavelengths using the relationship.</p> <p>Final mark is given for a statement that the calculated temperatures or wavelengths match values in the table.</p> <p>Graphical method:</p> <p>Graph drawn correctly (1) Gradient calculated (1) restatement of relationship (1)</p>

7. Scientists have recently discovered a type of particle called a pentaquark. Pentaquarks are very short lived and contain five quarks.

A lambda b (Λ_b) pentaquark contains the following quarks: 2 up, 1 down, 1 charm, and 1 anticharm quark.

- (a) Quarks and leptons are fundamental particles.

(i) Explain what is meant by the term *fundamental particle*.

1

(ii) State the name given to the group of matter particles that contains quarks and leptons.

1

- (b) The table contains information about the charge on the quarks that make up the Λ_b pentaquark.

Type of quark	Charge
up	$+\frac{2}{3}e$
down	$-\frac{1}{3}e$
charm	$+\frac{2}{3}e$
anticharm	$-\frac{2}{3}e$

Determine the total charge on the Λ_b pentaquark.

2

Space for working and answer



7. (continued)

- (c) One theory to explain the structure of the Λ_b pentaquark suggests that three of the quarks group together and one quark and the antiquark group together within the pentaquark.

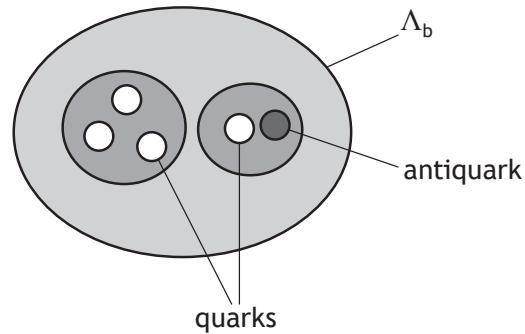

- (i) State the type of particle that is made of a quark-antiquark pair. 1

- (ii) The mean lifetime of another quark-antiquark pair is 8.0×10^{-21} s in its own frame of reference.

During an experiment the quark-antiquark pair is travelling with a velocity of $0.91c$ relative to a stationary observer.

Calculate the mean lifetime of this quark-antiquark pair relative to the stationary observer. 3

Space for working and answer



7. (continued)

(d) The Λ_b pentaquark has a mass-energy equivalence of 4450 MeV.

One eV is equal to 1.60×10^{-19} J.

(i) Determine the energy, in joules, of the Λ_b pentaquark.

1

Space for working and answer

(ii) Calculate the mass of the Λ_b pentaquark.

3

Space for working and answer



* X 8 5 7 7 6 0 1 2 0 *

Question			Expected response	Max mark	Additional guidance
7.	(a)	(i)	Fundamental particles are not composed of other particles.	1	Accept: Fundamental particles cannot be 'broken down' into other/smaller particles. Fundamental particles cannot be 'broken down' any further.
		(ii)	Fermions	1	
	(b)		$\frac{2}{3}e + \frac{2}{3}e - \frac{1}{3}e + \frac{2}{3}e - \frac{2}{3}e$ (1) $= 1e$ or $+1e$ or e (1)	2	Accept: $\frac{2}{3} + \frac{2}{3} - \frac{1}{3} + \frac{2}{3} - \frac{2}{3}$ OR $2(\frac{2}{3}e) - \frac{1}{3}e + \frac{2}{3}e - \frac{2}{3}e$ (1) $= 1e$ or $+1e$ or e (1)
	(c)	(i)	Meson	1	
		(ii)	$t' = \frac{t}{\sqrt{1 - \left(\frac{v}{c}\right)^2}}$ (1) $t' = \frac{8.0 \times 10^{-21}}{\sqrt{1 - \left(\frac{0.91c}{c}\right)^2}}$ (1) $t' = 1.9 \times 10^{-20} \text{ s}$ (1)	3	Accept: 2, 1.93, 1.930
	(d)	(i)	$(4450 \times 10^6 \times 1.60 \times 10^{-19})$ $= 7.12 \times 10^{-10} \text{ (J)}$	1	A unit is not required but, if a unit is given, it must be correct.
		(ii)	$E = mc^2$ (1) $7.12 \times 10^{-10} = m \times (3.00 \times 10^8)^2$ (1) $m = 7.91 \times 10^{-27} \text{ kg}$ (1)	3	Or consistent with (d) (i) Accept: 7.9, 7.911, 7.9111

8. The Sun emits energy at an average rate of $4.1 \times 10^{26} \text{ J s}^{-1}$. This energy is produced by nuclear reactions taking place inside the Sun.

The following statement shows one reaction that takes place inside the Sun.

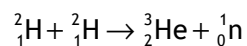

- (a) State the name given to this type of nuclear reaction.

1

- (b) The mass of the particles involved in this reaction are shown in the table.

Particle	Mass (kg)
${}^2_1\text{H}$	3.3436×10^{-27}
${}^3_2\text{He}$	5.0082×10^{-27}
${}^1_0\text{n}$	1.6749×10^{-27}

Determine the energy released in this reaction.

4

Space for working and answer



* X 8 5 7 7 6 0 1 2 2 *

MARKS DO NOT WRITE IN THIS MARGIN

8. (continued)

- (c) Determine the number of these reactions that would be required per second to produce the Sun's average energy output.

2

Space for working and answer

[Turn over



Question		Expected response	Max mark	Additional guidance
8.	(a)	(Nuclear) Fusion	1	
	(b)	<p>Mass before = $2 \times 3.3436 \times 10^{-27}$ $= 6.6872 \times 10^{-27}$</p> <p>Mass after = $5.0082 \times 10^{-27} + 1.6749 \times 10^{-27}$ $= 6.6831 \times 10^{-27}$</p> <p>Mass lost = 4.1×10^{-30} (kg)</p> <p style="text-align: right;">(1)</p> <p>$E = mc^2$ (1)</p> <p>$E = 4.1 \times 10^{-30} \times (3.00 \times 10^8)^2$ (1)</p> <p>$E = 3.69 \times 10^{-13}$ J (1)</p>	4	<p>Accept: 3.7, 3.690, 3.6900</p> <p>Check for correct substitutions of values in calculation of mass “lost”. If values are incorrect, maximum (1 mark) for relationship.</p> <p>$E = mc^2$ anywhere (1 mark)</p> <p>If mass before and after not used to full 5 significant figures from table, then maximum (1 mark) for relationship.</p> <p>Ignore inappropriate reference to mass defect.</p> <p>Arithmetic mistake can be carried forward through the response.</p> <p>Truncation error in mass before and/or mass after- maximum (1 mark) for relationship.</p>
	(c)	<p>$\frac{4.1 \times 10^{26}}{3.69 \times 10^{-13}}$ (1)</p> <p>$= 1.1 \times 10^{39}$ (1)</p>	2	<p>Or consistent with (b)</p> <p>Accept: 1, 1.11, 1.111</p>

9. A laser emits light when electrons are stimulated to fall from a high energy level to a lower energy level.

The diagram shows some of the energy levels involved.

In one particular laser, a photon is produced by the electron transition from E_5 to E_3 as shown.

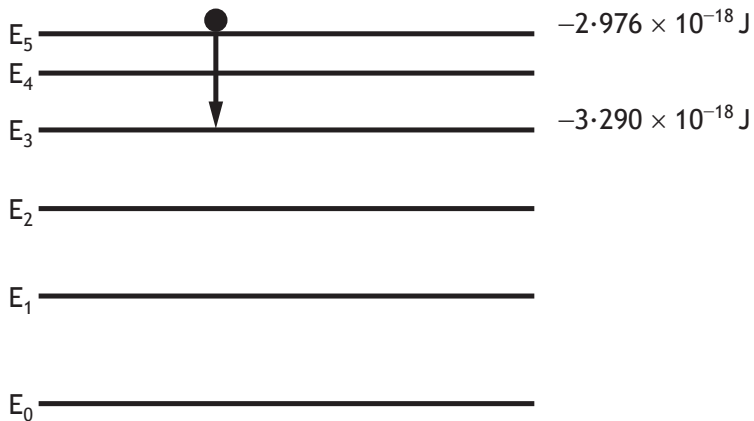

- (a) (i) Determine the wavelength of the photon emitted.

4

Space for working and answer



9. (a) (continued)

- (ii) The laser beam is shone onto a screen. The beam produces a spot of diameter 8.00×10^{-4} m.



The irradiance of the spot of light on the screen is 9950 W m^{-2} .

Determine the power of the laser beam.

4

Space for working and answer

- (b) A student investigates how irradiance I varies with distance d from a point source of light, using the apparatus shown.

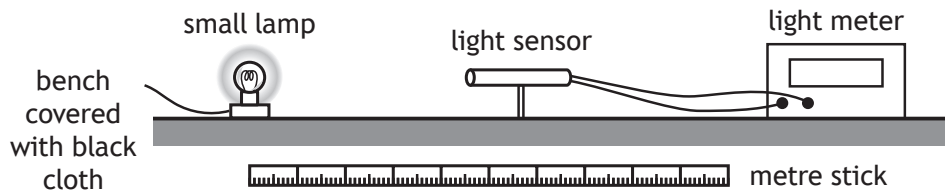

Describe how this apparatus could be used to verify the inverse square law for a point source of light.

3



Question			Expected response	Max mark	Additional guidance
9.	(a)	(i)	$E_2 - E_1 = hf$ $-2.976 \times 10^{-18} - (-3.290 \times 10^{-18}) \quad (1)$ $= 6.63 \times 10^{-34} \times f$ $(f = 4.736048265 \times 10^{14} \text{ Hz})$ $v = f\lambda \quad (1)$ (for both relationships anywhere) $3.00 \times 10^8 = 4.736048265 \times 10^{14} \times \lambda \quad (1)$ $\lambda = 6.33 \times 10^{-7} \text{ m} \quad (1)$	4	Accept: 6.3, 6.334, 6.3344 Accept: $(\Delta)E = hf$ with $v = f\lambda$ OR $E_2 - E_1 = hf$ with $v = f\lambda$ for relationship mark anywhere Note: $\Delta E = 3.14 \times 10^{-19} \text{ (J)}$ Accept: $3.290 \times 10^{-18} - 2.976 \times 10^{-18}$ $= 6.63 \times 10^{-34} \times f$ for energy substitution mark If $2.976 \times 10^{-18} - 3.290 \times 10^{-18}$ is shown for ΔE , maximum (1 mark) for both relationships. Alternative method: $E_2 - E_1 = \frac{hc}{\lambda}$ OR $(\Delta)E = \frac{hc}{\lambda}$ Combined relationship (1) Substitution for h and ΔE (1) Substitution for c (1) Final answer (1)
		(ii)	$A = \pi r^2$ $= \pi \times (4.00 \times 10^{-4})^2 \quad (1)$ $I = \frac{P}{A} \quad (1)$ $9950 = \frac{P}{\pi \times (4.00 \times 10^{-4})^2} \quad (1)$ $P = 5.00 \times 10^{-3} \text{ W} \quad (1)$	4	Accept a range of 1 to 5 significant figures for this question . The use of 3.14 for π is acceptable. $I = \frac{P}{A} \text{ anywhere -} \quad (1)$ If no attempt to calculate area, maximum (1 mark) for relationship.

Question		Expected response	Max mark	Additional guidance
9.	(b)	<p>Obtain values of irradiance for different distances (1)</p> <p>Plot graph of I against $1/d^2$ (1)</p> <p>Graph of I against $1/d^2$ is a straight line <u>through the origin</u> (then this verifies the inverse square law of light) (1)</p>	3	<p>Look for this statement or equivalent first - if incorrect or missing then (0 marks).</p> <p>Alternative method:</p> <p>Obtain values of irradiance for different distances (1)</p> <p>Determine $I \times d^2$ (1)</p> <p>Values of Id^2 are a constant (then this verifies the inverse square law of light) (1)</p>

10. A student carries out an experiment to investigate the effect of a grating on beams of light from three different lasers.

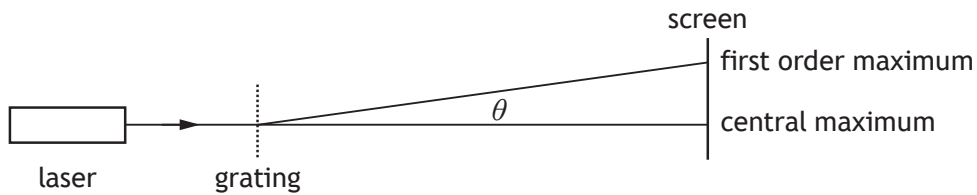

not to scale

The three different lasers produce red, green and blue light respectively.

Each laser beam is directed in turn towards the grating.

The grating has a slit separation of 3.3×10^{-6} m.

- (a) State which of these three colours of laser light would produce the smallest angle θ between the central maximum and the first order maximum.

Justify your answer.

3



10. (continued)

(b) The angle θ between the central maximum and the first order maximum for light from one of the lasers is 8.9° .

(i) Calculate the wavelength of this light.

3

Space for working and answer

(ii) Determine the colour of the light from this laser.

1

(iii) Another student suggests that a more accurate value for the wavelength of this laser light can be found if a grating with a slit separation of 5.0×10^{-6} m is used.

Explain why this suggestion is incorrect.

2

[Turn over



* X 8 5 7 7 6 0 1 2 7 *

Question		Expected response	Max mark	Additional guidance	
10.	(a)	<p>Blue (light) (1)</p> <p>Shortest wavelength of light (1)</p> <p>Path difference is smaller/equals the wavelength so the spots are closer together</p> <p>OR</p> <p>$\sin \theta$ is proportional to λ (1)</p>	3	<p>Look for this statement first - if incorrect or missing then (0 marks).</p> <p>Accept: $d \sin \theta = m\lambda$ and shortest λ gives smallest $\sin \theta$ (which gives smallest θ)</p> <p>Alternative methods: Can be shown by calculation but it must be clear the candidate has used appropriate wavelengths.</p>	
	(b)	(i)	<p>$m\lambda = d \sin \theta$ (1)</p> <p>$(1 \times) \lambda = 3 \cdot 3 \times 10^{-6} \times \sin 8 \cdot 9$ (1)</p> <p>$\lambda = 5 \cdot 1 \times 10^{-7} \text{ m (510 nm)}$ (1)</p>	3	<p>Accept: 5, 5.11, 5.105</p> <p>Accept: $\lambda = d \sin \theta$ in this case</p>
		(ii)	Green	<p>1</p> <p>Or consistent with (b)(i) but must be red, green or blue.</p> <p>If λ in (b)(i) lies outside of range of red, green or blue this mark is not accessible.</p>	

Question			Expected response	Max mark	Additional guidance
10.	(b)	(iii)	$(\sin \theta = \frac{m\lambda}{d}$ so if d is greater then) angle θ will be smaller (1) Smaller angle more difficult to measure accurately/greater <u>percentage</u> uncertainty. (1)	2	Accept: maxima are closer together (1) Smaller distance between maxima more difficult to measure accurately/greater percentage uncertainty.(1)

11. Diamonds sparkle because light that enters the diamond is reflected back to an observer.

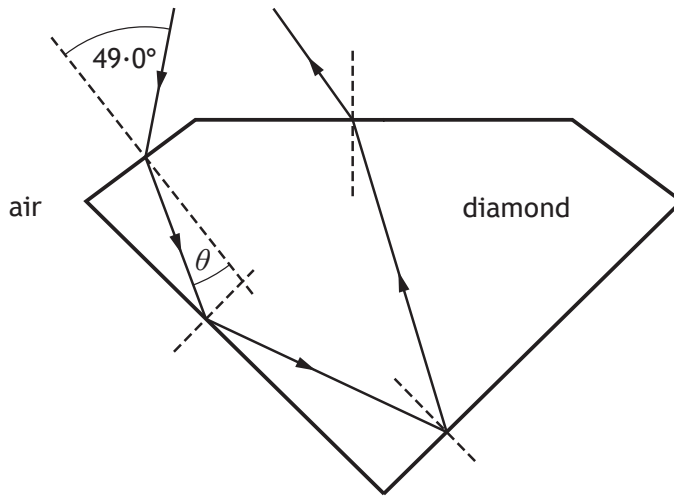

- (a) A ray of monochromatic light is incident on a diamond at an angle of 49.0° .
The refractive index of diamond for this light is 2.42.

Calculate the angle of refraction θ .

3

Space for working and answer

- (b) Calculate the critical angle of the diamond for this light.

3

Space for working and answer



MARKS

DO NOT
WRITE IN
THIS
MARGIN

11. (continued)

- (c) Moissanite is a transparent material with a greater refractive index than diamond. A sample of moissanite is made into the same shape as the diamond.

State whether the sample of moissanite sparkles more or less than the diamond.

You must justify your answer.

3

[Turn over



Question	Expected response	Max mark	Additional guidance
11. (a)	$n = \frac{\sin \theta_1}{\sin \theta_2} \quad (1)$ $2.42 = \frac{\sin 49.0}{\sin \theta_2} \quad (1)$ $\theta_2 = 18.2^\circ \quad (1)$	3	Accept: 18, 18.17, 18.172 Accept: $\frac{n_2}{n_1} = \frac{\sin \theta_1}{\sin \theta_2} \quad (1)$ $\frac{2.42}{1} = \frac{\sin 49.0}{\sin \theta_2} \quad (1)$ $\theta_2 = 18.2^\circ \quad (1)$
	$\sin \theta_c = \frac{1}{n} \quad (1)$ $\sin \theta_c = \frac{1}{2.42} \quad (1)$ $\theta_c = 24.4^\circ \quad (1)$	3	Accept: 24, 24.41, 24.407
	more (sparkle) (1) Critical angle for moissanite is smaller than for diamond (1) (Total internal) reflection more likely (with moissanite). (1)	3	Look for this statement first - if incorrect or missing then (0 marks) . Critical angle for moissanite is smaller than for diamond can be shown by calculation.

12. (a) A student sets up the circuit shown.

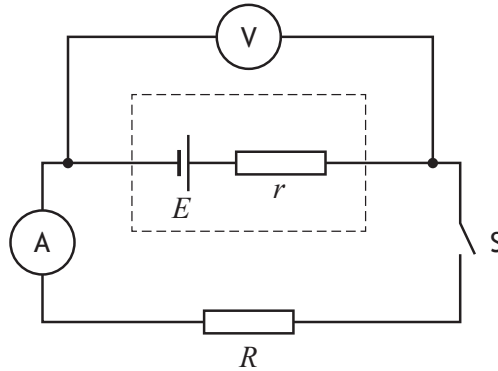

When switch S is open the reading on the voltmeter is 1.5 V .

Switch S is now closed.

The reading on the voltmeter is now 1.3 V and the reading on the ammeter is 0.88 A .

- (i) State the EMF E of the cell. 1
- (ii) Calculate the internal resistance r of the cell. 3
Space for working and answer
- (iii) Explain why the reading on the voltmeter decreases when the switch is closed. 2



12. (continued)

- (b) A battery of EMF 9.0V and internal resistance $1.2\ \Omega$ is connected in series with a lamp. The lamp has a resistance of $2.4\ \Omega$.

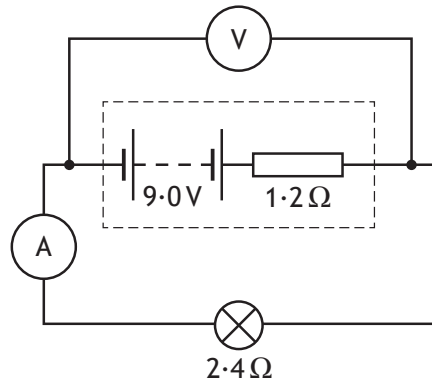

- (i) Determine the current in the lamp.

3

Space for working and answer

- (ii) Calculate the power dissipated in the lamp.

3

Space for working and answer



* X 8 5 7 7 6 0 1 3 1 *

Question			Expected response	Max mark	Additional guidance
12.	(a)	(i)	1.5 V	1	
		(ii)	$E = V + Ir$ (1) $1.5 = 1.3 + 0.88r$ (1) $r = 0.23 \Omega$ (1)	3	Accept: 0.2, 0.227, 0.2273 Alternative methods: $V = IR$ (1) $0.2 = 0.88 \times R$ (1) $R = 0.23 \Omega$ (1) lost volts = Ir (1) $0.2 = 0.88 \times R$ (1) $R = 0.23 \Omega$ (1)
		(iii)	(When the switch is closed) there is a current (in the circuit). (1) Voltage (is dropped) across the internal resistance. (1)	2	Independent marks Do not accept 'current increases' on its own. 'Lost volts' is not sufficient on its own
	(b)	(i)	$E = V + Ir$ and $V = IR$ (1) OR $E = I(R + r)$ $9.0 = I(2.4 + 1.2)$ (1) $I = 2.5 \text{ A}$ (1)	3	Accept: 3, 2.50, 2.500 Both relationships (1) Both substitutions (1) Alternative method: $V = IR$ (1) $9.0 = I \times 3.6$ (1) $I = 2.5 \text{ A}$ (1) For other alternative methods: All relationships (1) All substitutions (1) Correct final answer (1)
		(ii)	$P = I^2 R$ (1) $P = 2.5^2 \times 2.4$ (1) $P = 15 \text{ W}$ (1)	3	Or consistent with (b)(i) Accept 20, 15.0, 15.00 For alternative methods: All relationships (1) All substitutions (1) Correct final answer (1)

13. A student investigates the charging of a capacitor.

The student sets up the circuit as shown using a $47\ \mu\text{F}$ capacitor.

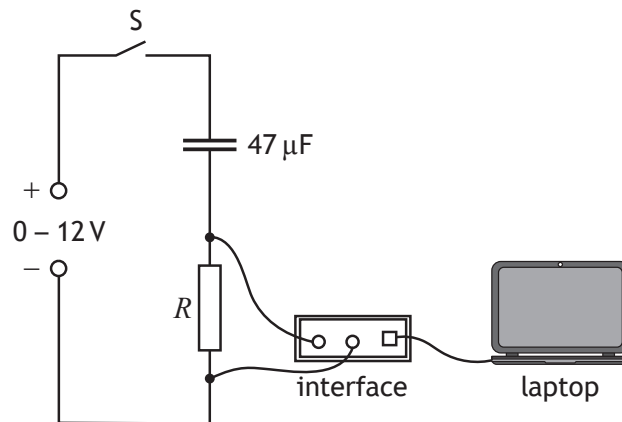

The capacitor is initially uncharged. The switch S is now closed. A laptop connected to an interface displays a graph of current against time as the capacitor charges.

- (a) The variable voltage supply is set at 6.0V .

Calculate the maximum charge stored by the capacitor.

Space for working and answer

3



* X 8 5 7 7 6 0 1 3 2 *

13. (continued)

- (b) The graph shows how the current I varies with time t as the capacitor charges.

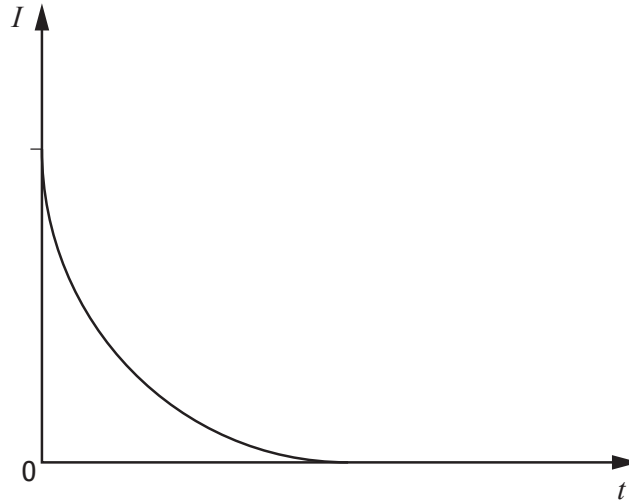

Switch S is opened, and the capacitor is discharged.

The resistor is now replaced with one that has a greater resistance.

Switch S is again closed and the capacitor charges.

Add a line to the graph above to show how the current now varies with time as the capacitor charges.

2

(An additional graph, if required, can be found on page 45.)

- (c) Suggest an alteration the student could make to this circuit to increase the maximum energy stored by the $47\ \mu\text{F}$ capacitor.

1

[Turn over

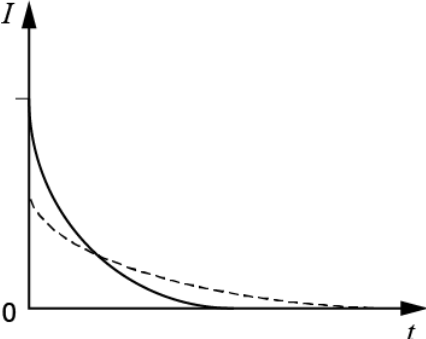

Question		Expected response	Max mark	Additional guidance
13.	(a)	$C = \frac{Q}{V} \quad (1)$ $47 \times 10^{-6} = \frac{Q}{6 \times 0} \quad (1)$ $Q = 2.8 \times 10^{-4} \text{ C} \quad (1)$	3	Accept: 3, 2.82, 2.820
	(b)	<p>Lower initial current (1) Longer charging time (1)</p> 	2	<p>Independent marks</p> <p>Line crossing x-axis - maximum (1) Line crossing y-axis - maximum (1) Line must be a curve to award the second mark.</p> <p>Line must tend towards the time axis to gain the second mark.</p> <p>Do not accept: increasing curve - 0 marks straight line - 0 marks</p>
	(c)	Increase the supply voltage	1	<p>Must clearly indicate the supply voltage is increased/greater.</p> <p>Accept: 'increase the voltage supplied to the circuit'. 'increase the voltage supplied to the capacitor'.</p> <p>Do not accept: 'increase the voltage across the capacitor' on its own.</p> <p>Do not accept any implication of power supply being replaced by another power supply.</p>

13. (continued)

(d) The use of analogies from everyday life can help improve the understanding of physics concepts.

Vehicles using a car park may be taken as an analogy for the charging of a capacitor.

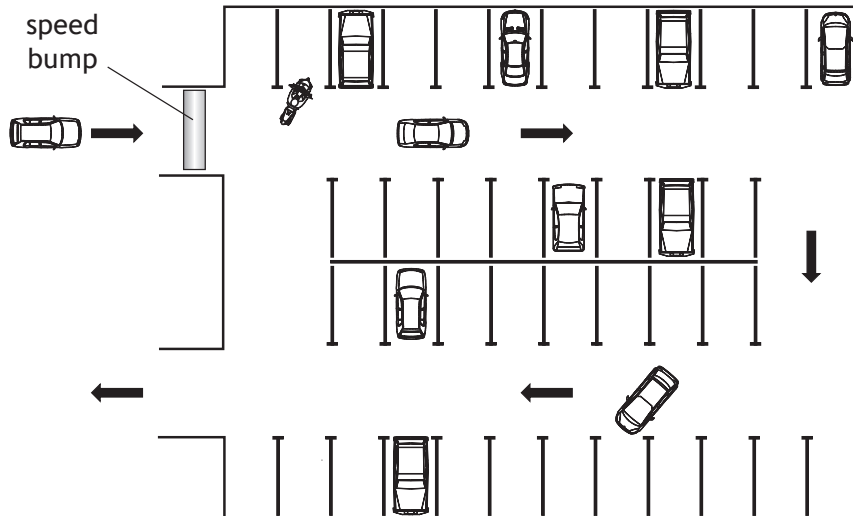

Use your knowledge of physics to comment on this analogy.

3



14. Solids can be categorised as conductors, insulators or semiconductors depending on their ability to conduct electricity. Their electrical conductivity can be explained using band theory.

The diagrams show the valence and conduction bands of three solids X, Y and Z.

One represents a conductor, one represents an insulator and one represents a semiconductor.

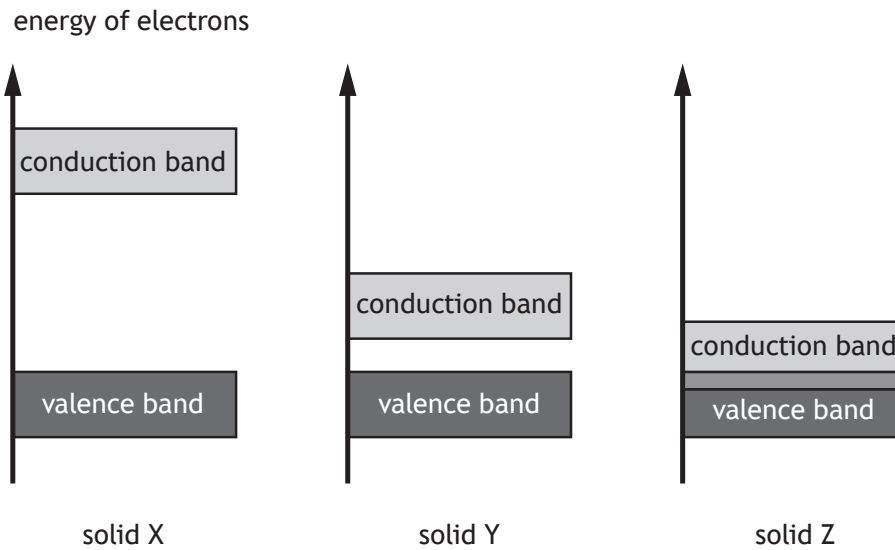

- (a) Complete the table to show which solid represents a conductor, an insulator and a semiconductor.

1

Solid	Category
X	
Y	
Z	



14. (continued)

(b) Using **band theory**, explain why conduction can take place in a semiconductor at room temperature.

2

(c) Silicon can be doped with arsenic to produce an n-type semiconductor. State the effect that doping has on the conductivity of silicon.

1

(d) Resistivity is a measure of a material's property to oppose the flow of charge.

The resistivity of silicon is $2.3 \times 10^3 \Omega \text{ m}$.

The resistivity of copper is $1.7 \times 10^{-8} \Omega \text{ m}$.

Compare the resistivity of silicon to the resistivity of copper in terms of orders of magnitude.

2

Space for working and answer



* X 8 5 7 7 6 0 1 3 7 *

Question		Expected response	Max mark	Additional guidance								
14.	(a)	<table border="1"> <thead> <tr> <th>Solid</th> <th>Category</th> </tr> </thead> <tbody> <tr> <td>X</td> <td>insulator</td> </tr> <tr> <td>Y</td> <td>semiconductor</td> </tr> <tr> <td>Z</td> <td>conductor</td> </tr> </tbody> </table>	Solid	Category	X	insulator	Y	semiconductor	Z	conductor	1	Must have all 3 correct.
Solid	Category											
X	insulator											
Y	semiconductor											
Z	conductor											
	(b)	<p>The energy gap/band gap (between the valence and conduction bands) is small. (1)</p> <p>Some electrons have enough energy to move from the valence to the conduction band. (1)</p>	2	<p>Independent marks</p> <p>To access second mark, valence and conduction band must be included in answer. The direction the electrons move must be clear.</p> <p>Do not accept: 'valency' as a name for the valence band.</p>								
	(c)	Increases (conductivity).	1	Do not accept: 'reduces resistance' on its own.								
	(d)	$\left(\frac{2.3 \times 10^3}{1.7 \times 10^{-8}}\right) = 1.4 \times 10^{11} \quad (1)$ <p>Resistivity of silicon is 11 (orders of magnitude) greater (1)</p>	2	<p>Accept: $\left(\frac{10^3}{10^{-8}}\right) = 10^{11}$</p> <p>OR</p> <p>$(3 - (-8)) = 11 \quad (1)$</p> <p>Accept: 11 greater on its own (2)</p> <p>OR</p> <p>Resistivity of copper is 11 (orders of magnitude) smaller. (2)</p>								

15. A 1.00 m long wooden rod has a series of small holes drilled at 10 mm intervals along its length. The rod is hung on a horizontal pin passing through a hole 50 mm from one end.

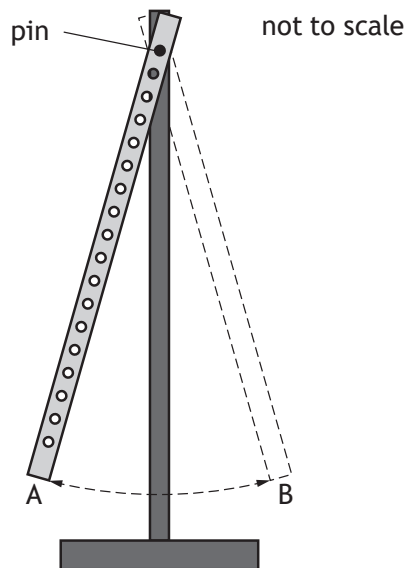

The rod is then raised through a small angle and released.

The period T is the time for the rod to travel from A to B and back to A.

- (a) Describe a method to obtain an accurate value for the period T using only a stopwatch.

2



15. (continued)

- (b) The rod is hung from different holes in turn, and the distance h from the pin to the midpoint of the rod is recorded.

T is determined for each value of h . The results are shown in the table.

h (m)	T (s)
0.45	1.60
0.40	1.56
0.35	1.54
0.30	1.53
0.25	1.53
0.22	1.55
0.20	1.58

- (i) Using the square-ruled paper on *page 41*, draw a graph of T against h . 3
- (ii) Using your graph, state the **two** values of h that produce a period of 1.57 s. 1
- (iii) (A) Using your graph, estimate the minimum period T . 1
- (B) Suggest an improvement to the experimental procedure that would allow a more precise value for the minimum period T to be determined. 1



* X 8 5 7 7 6 0 1 4 0 *

Back to Table

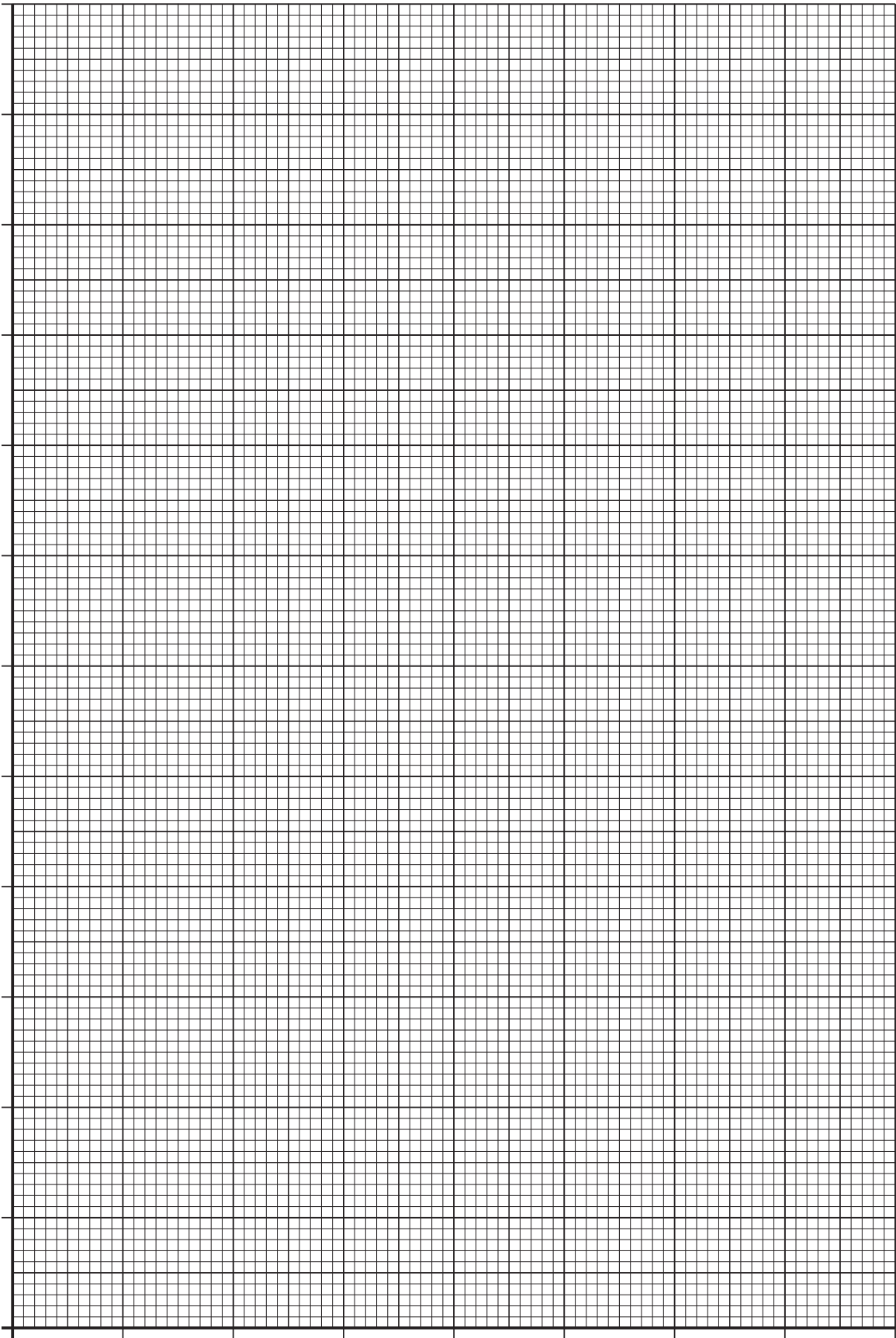

15. (continued)

(c) The quantities T and h are related by the relationship

$$T^2 h = \frac{4\pi^2 h^2}{g} + C$$

where g is the gravitational field strength and C is a constant.Use data from the table on page 40 to calculate a value for C when h is 0.30 m.

A unit is not required.

Space for working and answer

2

[END OF QUESTION PAPER]

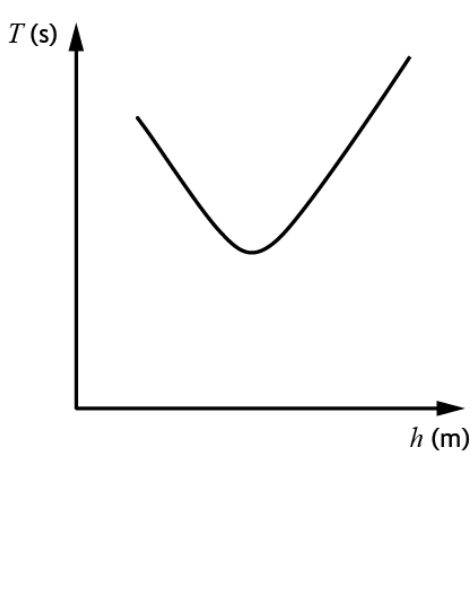

* X 8 5 7 7 6 0 1 4 2 *

Question		Expected response	Max mark	Additional guidance	
15.	(a)	Measure the total time over a number of swings (1) Divide total time by number of swings (1)	2		
	(b)	(i)		3	Appropriate labels and units (1) Suitable scales (1) Plotting and curve of best fit (1) Allow for axes starting at zero or broken axes or at an appropriate value. Accuracy of plotting should be easily checkable with the scale chosen If the origin is shown the scale must either be continuous or the axis must be 'broken'. Otherwise maximum (2 marks). Do not penalise if the candidate plots h against T .
		(ii)	0.21 and 0.42 m	1	must be consistent with candidate's graph
		(iii) (A)	1.53 s	1	must be consistent with candidate's graph
		(B)	Use smaller increments around the 'turning point'. OR Take more measurements about the 'turning point'. OR Take more measurements over the whole range.	1	Accept: More readings around/close to turning point or smaller 'steps' in h . Do not accept: 'Repeat experiment' on its own.
	(c)	$T^2h = \frac{4\pi^2h^2}{g} + C$ $1.53^2 \times 0 \times 30 = \frac{4 \times \pi^2 \times 0.30^2}{9.8} + C \quad (1)$ $C = 0.34 \quad (1)$	2	Accept: 0.3, 0.340, 0.3397 If candidate uses 3.14 for π , accept 0.3401. Ignore any unit given.	

[END OF MARKING INSTRUCTIONS]

DATA SHEET

COMMON PHYSICAL QUANTITIES

Quantity	Symbol	Value	Quantity	Symbol	Value
Speed of light in vacuum	c	$3.00 \times 10^8 \text{ m s}^{-1}$	Planck's constant	h	$6.63 \times 10^{-34} \text{ J s}$
Magnitude of the charge on an electron	e	$1.60 \times 10^{-19} \text{ C}$	Mass of electron	m_e	$9.11 \times 10^{-31} \text{ kg}$
Universal Constant of Gravitation	G	$6.67 \times 10^{-11} \text{ m}^3 \text{ kg}^{-1} \text{ s}^{-2}$	Mass of neutron	m_n	$1.675 \times 10^{-27} \text{ kg}$
Gravitational acceleration on Earth	g	9.8 m s^{-2}	Mass of proton	m_p	$1.673 \times 10^{-27} \text{ kg}$
Hubble's constant	H_0	$2.3 \times 10^{-18} \text{ s}^{-1}$			

REFRACTIVE INDICES

The refractive indices refer to sodium light of wavelength 589 nm and to substances at a temperature of 273 K.

Substance	Refractive index	Substance	Refractive index
Diamond	2.42	Water	1.33
Crown glass	1.50	Air	1.00

SPECTRAL LINES

Element	Wavelength/nm	Colour	Element	Wavelength/nm	Colour
Hydrogen	656	Red	Cadmium	644	Red
	486	Blue-green		509	Green
	434	Blue-violet		480	Blue
	410	Violet	Lasers		
	397	Ultraviolet	<i>Element</i>	<i>Wavelength/nm</i>	<i>Colour</i>
	389	Ultraviolet	Carbon dioxide	9550 } 10590 }	Infrared
Sodium	589	Yellow	Helium-neon	633	Red

PROPERTIES OF SELECTED MATERIALS

Substance	Density/kg m ⁻³	Melting point/K	Boiling point/K
Aluminium	2.70×10^3	933	2623
Copper	8.96×10^3	1357	2853
Ice	9.20×10^2	273
Sea Water	1.02×10^3	264	377
Water	1.00×10^3	273	373
Air	1.29
Hydrogen	9.0×10^{-2}	14	20

The gas densities refer to a temperature of 273 K and a pressure of $1.01 \times 10^5 \text{ Pa}$.



Relationships required for Physics Higher

$$d = \bar{v}t$$

$$s = \bar{v}t$$

$$v = u + at$$

$$s = ut + \frac{1}{2}at^2$$

$$v^2 = u^2 + 2as$$

$$s = \frac{1}{2}(u + v)t$$

$$F = ma$$

$$W = mg$$

$$E_w = Fd, \text{ or } W = Fd$$

$$E_p = mgh$$

$$E_k = \frac{1}{2}mv^2$$

$$P = \frac{E}{t}$$

$$p = mv$$

$$Ft = mv - mu$$

$$F = G \frac{m_1 m_2}{r^2}$$

$$t' = \frac{t}{\sqrt{1 - \left(\frac{v}{c}\right)^2}}$$

$$l' = l \sqrt{1 - \left(\frac{v}{c}\right)^2}$$

$$f_o = f_s \left(\frac{v}{v \pm v_s} \right)$$

$$z = \frac{\lambda_{\text{observed}} - \lambda_{\text{rest}}}{\lambda_{\text{rest}}}$$

$$z = \frac{v}{c}$$

$$v = H_0 d$$

$$W = QV$$

$$E = mc^2$$

$$I = \frac{P}{A}$$

$$I = \frac{k}{d^2}$$

$$I_1 d_1^2 = I_2 d_2^2$$

$$E = hf$$

$$E_k = hf - hf_0$$

$$v = f\lambda$$

$$E_2 - E_1 = hf$$

$$d \sin \theta = m\lambda$$

$$n = \frac{\sin \theta_1}{\sin \theta_2}$$

$$\frac{\sin \theta_1}{\sin \theta_2} = \frac{\lambda_1}{\lambda_2} = \frac{v_1}{v_2}$$

$$\sin \theta_c = \frac{1}{n}$$

$$V_{\text{rms}} = \frac{V_{\text{peak}}}{\sqrt{2}}$$

$$I_{\text{rms}} = \frac{I_{\text{peak}}}{\sqrt{2}}$$

$$T = \frac{1}{f}$$

$$V = IR$$

$$P = IV = I^2 R = \frac{V^2}{R}$$

$$R_T = R_1 + R_2 + \dots$$

$$\frac{1}{R_T} = \frac{1}{R_1} + \frac{1}{R_2} + \dots$$

$$V_1 = \left(\frac{R_1}{R_1 + R_2} \right) V_S$$

$$\frac{V_1}{V_2} = \frac{R_1}{R_2}$$

$$E = V + Ir$$

$$C = \frac{Q}{V}$$

$$Q = It$$

$$E = \frac{1}{2} QV = \frac{1}{2} CV^2 = \frac{1}{2} \frac{Q^2}{C}$$

$$\text{path difference} = m\lambda \text{ or } \left(m + \frac{1}{2}\right)\lambda \text{ where } m = 0, 1, 2, \dots$$

$$\text{random uncertainty} = \frac{\text{max. value} - \text{min. value}}{\text{number of values}}$$

or

$$\Delta R = \frac{R_{\text{max}} - R_{\text{min}}}{n}$$

Additional relationships

Circle

$$\text{circumference} = 2\pi r$$

$$\text{area} = \pi r^2$$

Sphere

$$\text{area} = 4\pi r^2$$

$$\text{volume} = \frac{4}{3}\pi r^3$$

Trigonometry

$$\sin \theta = \frac{\text{opposite}}{\text{hypotenuse}}$$

$$\cos \theta = \frac{\text{adjacent}}{\text{hypotenuse}}$$

$$\tan \theta = \frac{\text{opposite}}{\text{adjacent}}$$

$$\sin^2 \theta + \cos^2 \theta = 1$$

Electron arrangements of elements

Group 1 Group 2

(1)

1 H Hydrogen	2 He Helium
3 Li Lithium	4 Be Beryllium
11 Na Sodium	12 Mg Magnesium
19 K Potassium	20 Ca Calcium
2,8,8,1 Rb Rubidium	38 Sr Strontium
2,8,18,18,8,1 Cs Caesium	56 Ba Barium
2,8,18,32,18,8,1 Fr Francium	88 Ra Radium

Key

Atomic number
Symbol
Electron arrangement
Name

Transition elements

(3)	(4)	(5)	(6)	(7)	(8)	(9)	(10)	(11)	(12)
21 Sc Scandium	22 Ti Titanium	23 V Vanadium	24 Cr Chromium	25 Mn Manganese	26 Fe Iron	27 Co Cobalt	28 Ni Nickel	29 Cu Copper	30 Zn Zinc
39 Y Yttrium	40 Zr Zirconium	41 Nb Niobium	42 Mo Molybdenum	43 Tc Technetium	44 Ru Ruthenium	45 Rh Rhodium	46 Pd Palladium	47 Ag Silver	48 Cd Cadmium
57 La Lanthanum	72 Hf Hafnium	73 Ta Tantalum	74 W Tungsten	75 Re Rhenium	76 Os Osmium	77 Ir Iridium	78 Pt Platinum	79 Au Gold	80 Hg Mercury
89 Ac Actinium	104 Rf Rutherfordium	105 Db Dubnium	106 Sg Seaborgium	107 Bh Bohrium	108 Hs Hassium	109 Mt Meitnerium	110 Ds Darmstadtium	111 Rg Roentgenium	112 Cn Copernicium

Lanthanides

57 La Lanthanum	58 Ce Cerium	59 Pr Praseodymium	60 Nd Neodymium	61 Pm Promethium	62 Sm Samarium	63 Eu Europium	64 Gd Gadolinium	65 Tb Terbium	66 Dy Dysprosium
2,8,18,18,9,2	2,8,18,20,8,2	2,8,18,21,8,2	2,8,18,22,8,2	2,8,18,23,8,2	2,8,18,24,8,2	2,8,18,25,8,2	2,8,18,25,9,2	2,8,18,27,8,2	2,8,18,28,8,2

Actinides

89 Ac Actinium	90 Th Thorium	91 Pa Protactinium	92 U Uranium	93 Np Neptunium	94 Pu Plutonium	95 Am Americium	96 Cm Curium	97 Bk Berkelium	98 Cf Californium
2,8,18,32,18,9,2	2,8,18,32,18,10,2	2,8,18,32,20,9,2	2,8,18,32,21,9,2	2,8,18,32,22,9,2	2,8,18,32,24,8,2	2,8,18,32,25,8,2	2,8,18,32,25,9,2	2,8,18,32,27,8,2	2,8,18,32,28,8,2

Group 3 Group 4 Group 5 Group 6 Group 7 Group 8

(18)

(13)	(14)	(15)	(16)	(17)	(18)
5 B Boron	6 C Carbon	7 N Nitrogen	8 O Oxygen	9 F Fluorine	10 Ne Neon
13 Al Aluminium	14 Si Silicon	15 P Phosphorus	16 S Sulfur	17 Cl Chlorine	18 Ar Argon
2,8,3	2,8,4	2,8,5	2,8,6	2,8,7	2,8,8
31 Ga Gallium	32 Ge Germanium	33 As Arsenic	34 Se Selenium	35 Br Bromine	36 Kr Krypton
2,8,18,3	2,8,18,4	2,8,18,5	2,8,18,6	2,8,18,7	2,8,18,8
49 In Indium	50 Sn Tin	51 Sb Antimony	52 Te Tellurium	53 I Iodine	54 Xe Xenon
2,8,18,18,3	2,8,18,18,4	2,8,18,18,5	2,8,18,18,6	2,8,18,18,7	2,8,18,18,8
81 Tl Thallium	82 Pb Lead	83 Bi Bismuth	84 Po Polonium	85 At Astatine	86 Rn Radon
2,8,18,32,18,3	2,8,18,32,18,4	2,8,18,32,18,5	2,8,18,32,18,6	2,8,18,32,18,7	2,8,18,32,18,8